

Data Acquisition / Memory Recorders / pen Recorders / Data Loggers /  
multichannel Loggers / Impedance Analyzers / LCR/Resistance Meters / Battery  
Testers / Super Megohm Testers / DMM / Signal Generators/Calibrators /  
Electrical Safety Analyzers / Insulation Withstanding Testers / Leakage Current  
Testers / Protective Ground Testers / Power Meters / Power Analyzers / Power  
Quality Analyzers / Power Loggers / Current probes / Current Sensors / Power  
Meters / Optical Power Meters / PV maintenance Tester / Low Voltage  
Testers / Magnetic Field/Temperature/Sound Level/Impedance  
Digital Multimeters(DMM) test sets/temperature test sets



**Impedance Analyzers  
Battery Testers**



**Recorders  
Data Loggers**



**Power Meters  
Power Analyzers**





**Current Probes  
Clamp Sensors**

# Batteries are a driving force for a variety of innovations as we move towards a sustainable society

Batteries are used in an array of applications, and their performance can be a driving force for a variety of innovations and new lifestyles. The development and production of high-quality batteries will play an essential role as we work to realize a sustainable society. At the same time therefore, growing improvements in battery life cycle assessment have become a major priority. The focus on reducing CO2 emissions throughout the entire life cycle by means of improvements in manufacturing processes and reuse of high-quality batteries is increasing. HIOKI battery testers are helping resolve these issues through an electrical measurement approach.

## Internal resistance and open-circuit voltage for various battery types and compatible instruments

Battery tester voltage measurement ranges		Stacked battery voltage	Internal resistance of battery cells				
			0.1 mΩ	1 mΩ	10 mΩ	100 mΩ	1 Ω
BT3564 ranges 10 V 100 V 1000 V	1000 V	1000 V	 <p>EV bus 800 V to 1000 V, &lt; 0.2 mΩ</p>				
			 <p>Storage batteries for home use 200 V to 400 V, 0.3 mΩ to 1 mΩ</p> <p>EV car 200 V to 400 V, 0.3 mΩ to 1 mΩ</p>				
BT3563A ranges BT3563-01 6 V 60 V 300 V	230 V	230 V					
BT3562A ranges 6 V 60 V 100 V	96 V	96 V	 <p>Forklift 72 V to 96 V, &lt; 1 mΩ</p> <p>Electric Motorcycle 48 V to 96 V, &lt; 10 mΩ</p> <p>Electric tricycle 48 V to 96 V, &lt; 10 mΩ</p>				
			 <p>5G base station 24 V to 48 V, &lt; 10 mΩ</p> <p>Automatic transfer robot 24 V to 48 V, &lt; 10 mΩ</p> <p>Large drones 24 V to 48 V, &lt; 10 mΩ</p>				
BT3562-01 ranges BT3561A 6 V 60 V	48 V	48 V					
3561 ranges 3561-01 BT4560* *Special specifications	12 V	12 V	 <p>Power tool 12 V to 24 V, &lt; 10 mΩ</p> <p>Cleaner 12 V to 24 V, &lt; 10 mΩ</p> <p>Electric bike 24 V, &lt; 10 mΩ</p> <p>Laptop 7 V to 12 V, &lt; 100 mΩ</p>				
			 <p>Tablet 3.7 V, &lt; 10 mΩ</p>				
BT4560 ranges 5 V	3.7 V	3.7 V	 <p>Smart phone 3.7 V, &lt; 100 mΩ</p> <p>Smart watch 3.7 V, &lt; 300 mΩ</p> <p>Coin cell, All solid-state cell 3.7 V, &lt; 1 Ω</p>				
			<p>3 mΩ 1.5 A measurement current BT4560</p>				
			<p>3 mΩ 100 mA</p>				
			<p>30 mΩ 100 mA</p>				
			<p>300 mΩ 10 mA</p>				
			<p>3 Ω - 3 kΩ 1 mA - 10 μA</p>				
			<p>BT3562A, BT3563A, BT3564, BT3562-01, BT3563-01 (3561, 3561-01: 300 mΩ, 3 Ω range) (BT3561A: 30 mΩ to 3 kΩ range)</p>				
			<p>Battery tester resistance measurement ranges</p>				

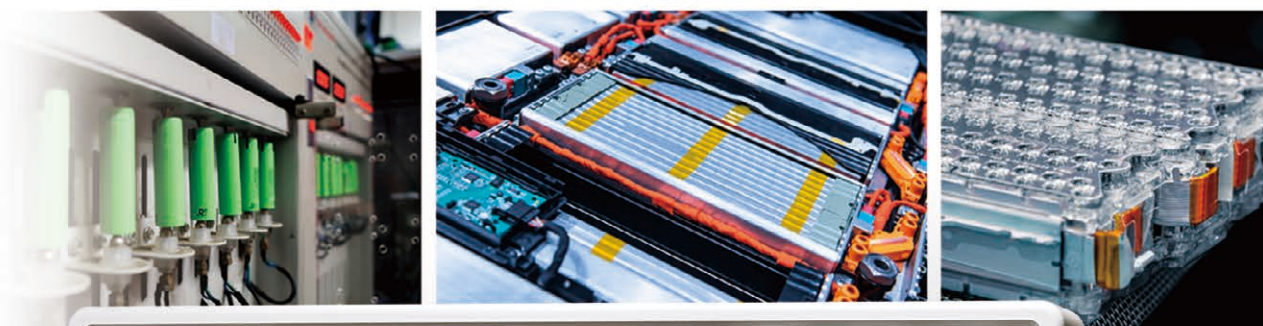

# BATTERY TESTER Series



## BT3561A

- Compact power cells
- Compact packs up to 60 V



## BT3562A

- Large cells for xEVs
- Medium-size packs up to 100 V



## BT3563A

- Large packs for xEVs
- Large packs up to 300 V

Inspect the quality of completed cells, modules, and packs on production lines.  
Measure internal resistance (AC-IR) and open-circuit voltage (OCV) to check battery quality.

# High-Precision Measurement Solutions Improving Motor Performance and Quality

Hioki offers a diverse array of motor measurement solutions that can be used in applications ranging from performance analysis to quality testing. The ability to assess and analyze using high-precision measurement technologies provides valuable assistance to engineers as they work to increase motor performance and quality.

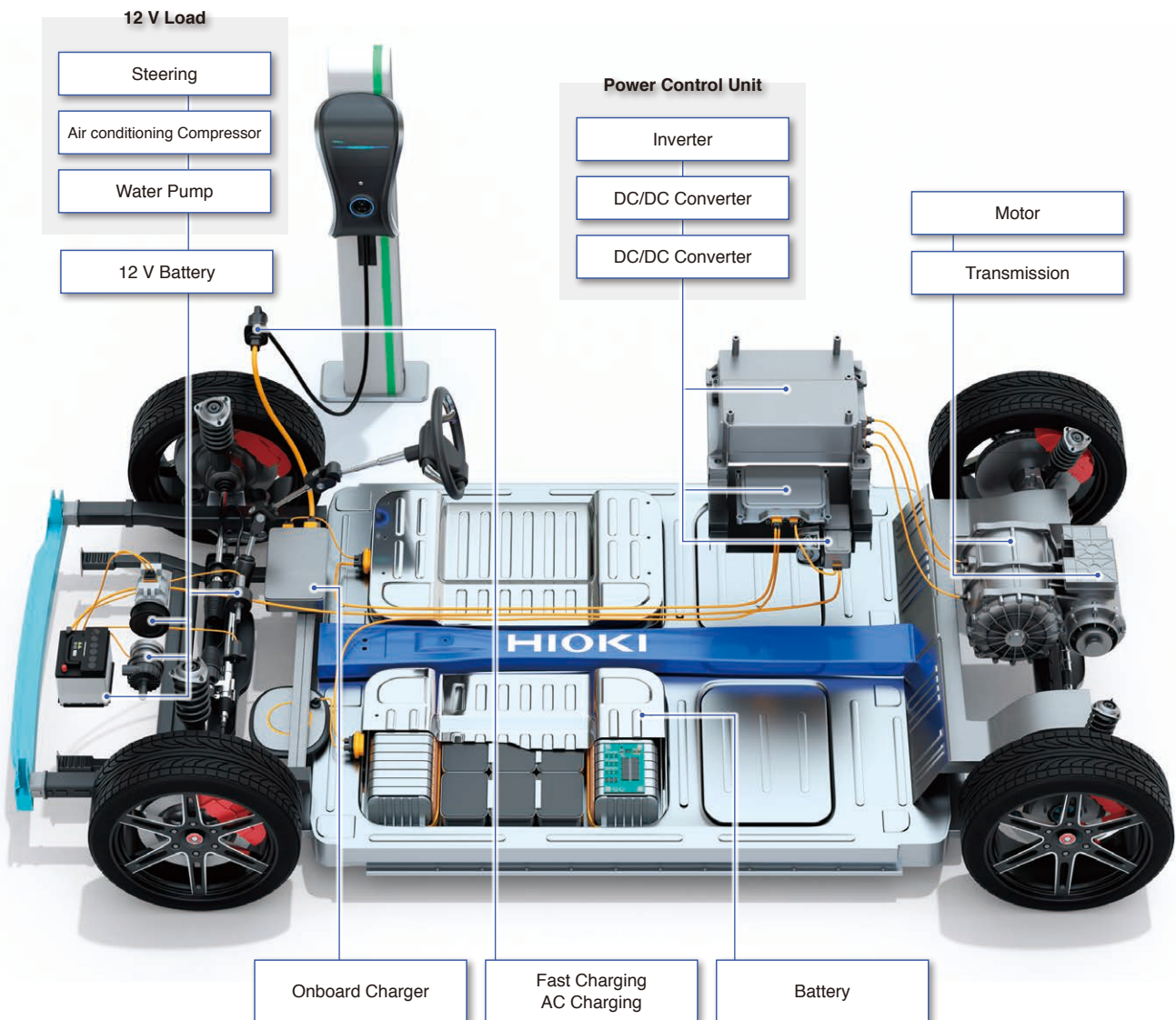

POWER ANALYZER  
PW6001**Design/  
Development****Evaluating Inverter Motor Efficiency and Loss**

Simultaneously measure inverter input and output power, and motor output.  
Evaluate inverter, motor, and overall system efficiency and loss in an accurate and highly reproducible manner.

POWER ANALYZER  
PW6001**Design/  
Development****Inverter Motor ECU Measurement and Compliance Testing**

Make quick work of PCU compliance testing by taking advantage of PW6001 and INCA\*1 link functionality so that you can use the PW6001 to perform accurate power and motive power measurement. You can simultaneously monitor CAN bus data and ECU RAM values.

POWER ANALYZER  
PW6001**Design/  
Development****Identifying PMSM Motor Parameters**

Identify more accurate motor control motor control by using motor parameters measured under actual operating conditions in upstream design processes.

POWER ANALYZER  
PW3390**Design/  
Development****Test Automobile Fuel Economy**

Taking fuel economy measurements that comply with WLTP international standards requires the precise measurement of current integration and power integration for the recharging/discharging of each battery in the system. High accuracy clamp current sensors, the excellent DC accuracy of the PW3390, and the ability to integrate current and power at 50 ms intervals are extremely effective in meeting this application.

MEMORY HILOGGER  
LR8450**Design/  
Development****Measuring Motor Temperature**

Apply thermocouples to the motor frame and winding to record temperature variations.  
Display and record differences in temperature relative to the measurement environment as a waveform in real time.

MEMORY HIRecorder  
MR6000/MR6000-01**Design/  
Development****EV and EV Motor Evaluation Using CAN/CAN FD**

Accurately assess behavior during HILS testing and vehicle evaluation by simultaneously measuring control and sensor data on the CAN bus and actual analog values.

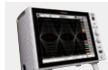
MEMORY HIRecorder  
MR6000/MR6000-01**Design/  
Development****Measuring Dynamic Motor Characteristics**

Record inverter output voltage and current, torque, and RPM from motor start to stop.  
Calculate inverter output power, motor power, and motor efficiency using waveform calculations.

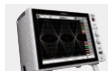
MEMORY HIRecorder  
MR6000/MR6000-01**Design/  
Development****Measuring Motor Torque Vibrations**

Measure torque and vibration, and analyze behavior during motor operation.  
Discover resonance phenomena and other unpredicted frequency components by using FFT calculations to perform a frequency analysis.

MEMORY HIRecorder  
MR6000/MR6000-01**Design/  
Development****Measuring Resolver Rotation Angles**

Record the resolver rotor excitation and output signal, and calculate the rotation angle using waveform calculation functionality.  
Verify motor control sequences by analyzing the relationship between the resolver rotation angle and other signals.

IMPULSE WINDING TESTER  
ST4030A**Production/  
Testing****Performing Layer Short Testing of Motor Windings**

Detect insulation failures (layer shorts) and deterioration in motor windings.  
Generate pass/fail judgments with greater precision than conventional approaches by quantifying response waveforms.

IMPULSE WINDING TESTER  
ST4030A**Production/  
Testing****Performing Motor Winding Maintenance**

Perform impulse testing and use the results in motor winding maintenance and trend management.

AUTOMATIC INSULATION/  
WITHSTANDING HI TESTER  
3153**Production/  
Testing****Observation of Partial Discharges During Breakdown Voltage Testing**

Detect partial discharges by observing current and voltage waveforms during breakdown voltage testing. By checking for partial discharges, which can lead to insulation breakdown, you can ascertain whether a coil contains any latent defects.

INSULATION TESTER  
ST5520**Production/  
Testing****Measuring Motor and Winding Insulation Resistance and Breakdown Voltage**

Carry out insulation resistance and breakdown voltage testing.  
Ensure a high level of safety by testing the state of insulation as part of shipping inspections.

RESISTANCE METER  
RM3545**Production/  
Testing****Measuring Winding Resistance**

Check for wire breaks by measuring winding resistance with a high level of precision.  
Check for incorrect wire thickness and turn count by using a high-precision resistance meter to make the measurements.

LCR METER  
IM3536**Production/  
Testing****Measuring Motor Coil Inductance**

Measure winding inductance.  
Check phase balance, motor dynamic performance, RPM variations, and compatibility of the driver and motor.

RESISTANCE METER  
RM3545-02**Production/  
Testing****Measuring Motor Weld Resistance**

Test weld quality (check for weld defects) in rectangular wire stators using a DC resistance meter with high resolution and measurement accuracy.

# Applications

# Data Centers

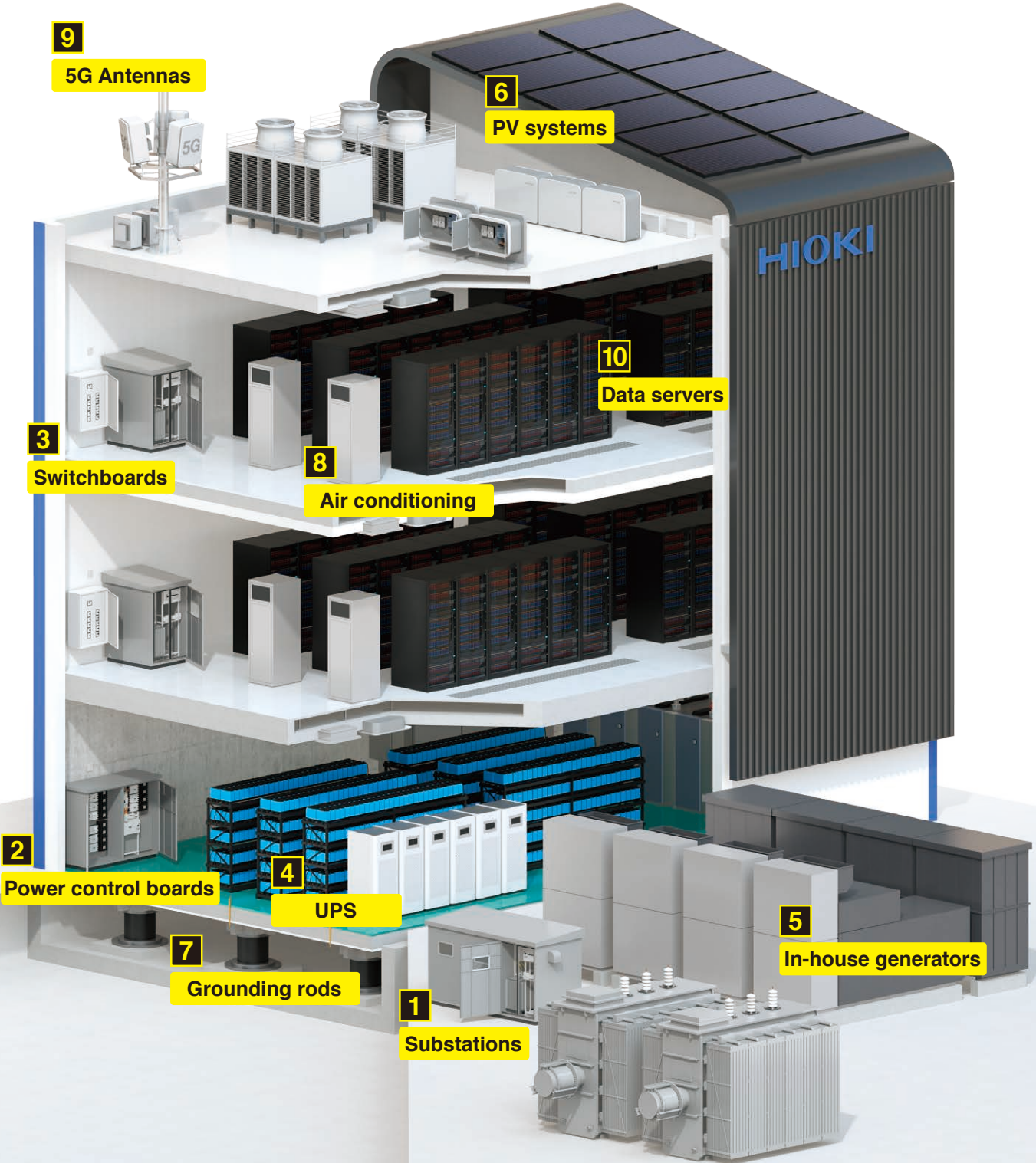

**1 2 3**

**Power receiving and transforming equipment • Power control boards • Switchboards**

<p><b>Verify phase rotation</b></p> <p>PD3259 PD3129</p>	<p><b>Test insulation</b></p> <p>IR405Xs</p>	<p><b>Test supply voltage</b></p> <p>DT42XXs</p>	<p><b>Verify load current</b></p> <p>CM437Xs CM414Xs</p>	<p><b>Detect leakage current</b></p> <p>CM4001 CM4002 CM4003</p>	<p><b>Detect electrical disturbances • Analyze power quality</b></p> <p>PQ3100 PQ3198</p>	<p><b>Record and analyze electrical consumption</b></p> <p>PW3360 PW3365</p>	<p><b>Test 5kV insulation</b></p> <p>IR3455</p>
--	--	--	--	--	---	--	---

**4**

**UPS**

**5**

**Power generators**

<p><b>Test battery resistance and voltage</b></p> <p>BT3554</p>	<p><b>Verify motor insulation</b></p> <p>IR405Xs</p>	<p><b>Test supply voltage</b></p> <p>DT425Xs DT428Xs</p>	<p><b>Test load current</b></p> <p>CM437Xs CM414Xs</p>	<p><b>Verify phase rotation</b></p> <p>PD3259 PD3129</p>
---	--	--	--	--

**6**

**PV systems**

**7**

**Earth • ground**

<p><b>Test bypass diodes</b></p> <p>FT4310</p>	<p><b>Verify grounding</b></p> <p>FT6031</p>	<p><b>Test PV insulation</b></p> <p>IR4053</p>	<p><b>Verify string voltage</b></p> <p>DT4261 + P2000</p>	<p><b>Verify string current</b></p> <p>CM437Xs CM414Xs</p>	<p><b>Verify grounding</b></p> <p>FT6031</p>
--	--	--	---	--	--

**8 9**

**Air conditioning • 5G Antennas**

**10**

**Servers**

<p><b>Check temperature and humidity</b></p> <p>LR5001 LR8514</p>	<p><b>Check temperature</b></p> <p>FT3700 FT3701</p>	<p><b>Test insulation</b></p> <p>IR405Xs</p>	<p><b>Test supply voltage</b></p> <p>DT425Xs DT428Xs</p>	<p><b>Test load current</b></p> <p>CM437Xs CM414Xs</p>	<p><b>Verify LAN wiring</b></p> <p>3665</p>
---	--	--	--	--	---

# GENNECT

for mobile devices

## GENNECT Cross

GENNECT Cross  
Dedicated website



### Checking and saving measured values



The measurement values displayed on the instrument can be displayed and saved on the tablet in real time.

### Record fluctuations in measured values

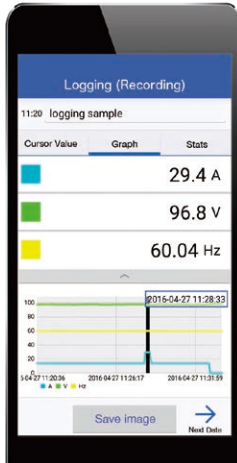

Measurement values can be saved at set recording intervals. You can also check the maximum, minimum, and average values.

### Waveform observation/FFT analysis



Waveforms such as current and voltage, and FFT analysis waveforms can be displayed.

### Record on photos and drawings



Measurements can be recorded on top of captured photos or imported drawing data.

### Report writing

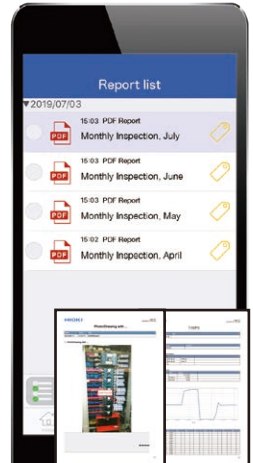

You can create reports from saved data, exporting them as PDF, JPG, or CSV.

### Display judgment results in color and bar graph



The measured value is compared with the judgment value, and the result is displayed in PASS/WARNING/FAIL.

### Check power quality by analyzing harmonics up to the 30th order

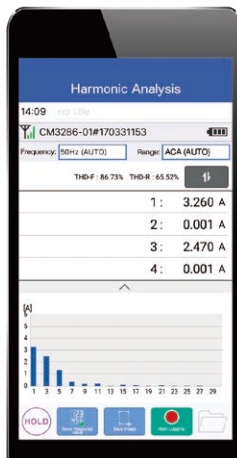

Calculate and display harmonic levels for individual orders, content percentages, and total harmonic distortion (THD-F and THDR).

### Record the occurrence of intermittent leakage current

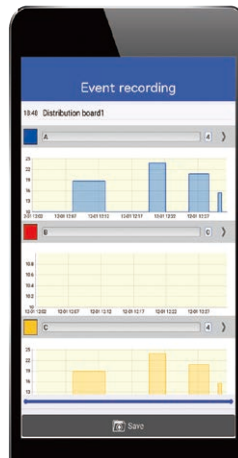

When a value greater than the threshold is measured, the time of occurrence, end time, and the maximum value for that period are recorded.

### Display of disequilibrium rates and vector diagrams



Displays the disequilibrium rate and vector diagram.

### Audio guidance about the battery measurement sequence

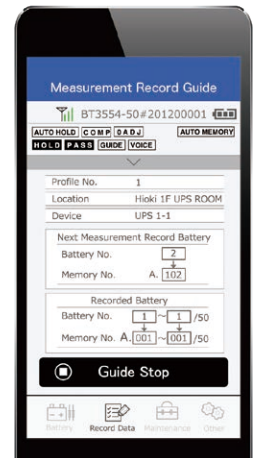

The app provides audio guidance about the battery measurement sequence. And, automatically saves the measurement results.

**Supported instruments** (Available functions vary depending on the measurement device. For details, please visit the GENNECT Cross special website.)

Z3210 not required.



FT3425

FT4310



CM7291

Wireless adapter Z3210 (optional) must be attached to use GENNECT Cross.



CM4371-50

CM4373-50

CM4375-50

CM4141-50

CM3286-50

CM4001

CM4002



CM4003



IR4057-50



FT6031-50



FT6380-50



PD3259-50



BT3554-5x



DT4261



WIRELESS ADAPTER Z3210 (Option)



Attach to enable Bluetooth® wireless technology

### Downloading GENNECT Cross

Data can be downloaded to tablets and smartphones using Hioki's dedicated app available from the Google Play or App Store. Search for "HIOKI" and download the "GENNECT Cross" app



for PCs



GENNECT One  
Dedicated website



New Product Information

- Category Index
- Recorders Data Loggers
- LRP / Resistance Meters
- Safety Testing
- Power Meters
- Current Sensors
- Optical / PM maintenance Telecommunication
- Environmental Measuring
- DMM/Testers Field Measuring
- New Solutions Meter Relays
- Bare Board & Package Testing
- Model No. Index / Other

## Connect to and manage instruments with a computer

Collect and Display measured values by instrument



**Collect values in graphs and lists**

**Logging:** When logging is started, measurement data is acquired at regular intervals from multiple measuring instruments. The acquired data is displayed and stored on the PC in real time.



**Combine images and other elements**

**Dashboard:** Create a dashboard by laying out measurements, background images, and other parts on the screen. You can display the measured values on the dashboard in real time.

Change instrument settings from your office



**Change instrument settings from a computer**

**Remote control:** Available to change the settings of the instrument and start and stop the measurement from the PC.  
**Instrument clock synchronization:** The clock of the measuring instrument can be synchronized with the PC clock.

Collect and organize measurement files from scattered locations

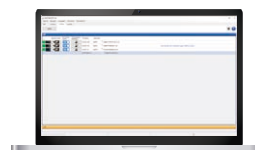

**Transfer measurement files to a computer**

**Automatic file transfer:** Measurement data stored in the instrument can be automatically transferred to the PC.

**Data import:** The measurement data stored in the instrument can be transferred to the PC manually.

**Review acquired files on a single time axis**

**Time-series viewer:** After acquiring the measurement data stored in the main unit of the instrument, the data can be checked in a single time series.

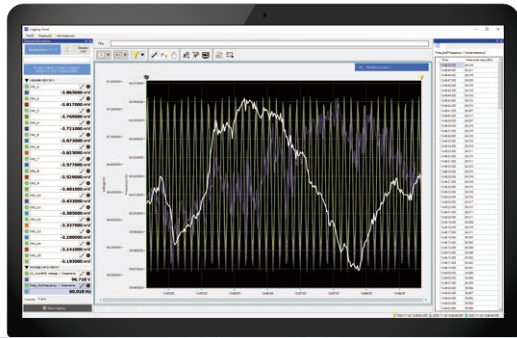

HUB

Connect each measuring instrument with LAN cable (BT3554-5x series is USB connection)

<p>LAN</p> <p><b>Power Analysis</b></p>	<p>LAN</p> <p><b>Monitoring Power Quality</b></p>	<p>LAN</p> <p><b>Understanding Power Consumption</b></p>
<p>LAN</p> <p><b>Voltage and temperature management</b></p>	<p>LAN</p> <p><b>Waveform Analysis</b></p>	<p>USB</p> <p><b>UPS Inspection</b></p>



**Supported instruments** (Available functions vary depending on the measurement device. For details, please visit the GENNECT One special website.)

PW8001	PW6001	PW3390	PQ3198	PQ3100	PW3365	PW3360	LR8410	LR8450	MR6000	BT3554-50
								LR8450-01		BT3554-51
										BT3554-52

### Downloading GENNECT One

GENNECT One is a free PC application. Please download from the HIOKI website by going to the "GENNECT One" landing page.

**NEW**

Easy to set up!  
Simply plug in the Z3210 wireless adapter and  
your compatible HIOKI device is Bluetooth® ready!

## Get connected!

Z3210 is a Bluetooth® wireless adapter that will:

- Increase your work efficiency, by eliminating human errors from manual reporting
- Transfer readings on instruments to easy-to-read graphical reports to prove integrity
- Increase your work productivity & save costs!
- Provide additional new functions for HIOKI devices such as waveform display & more!



**Z3210 web site**

For more information on supported regions and products, please visit this dedicated site.

Work even smarter with our new Z3210 wireless adapter!  
Now you can create and share graphical reports in a flash!













**GENNECT Cross App**



**Excel® Direct Input**

# Contents

	<b>HIOKI's Philosophy</b> ..... P.2 <b>About the Catalog</b> ..... P.4 <b>Ensuring Safe Operation of the Product</b> .... P.5 <b>Category Index</b> ..... P.6 - 18	Category Index
	Data Acquisition, Memory Recorders, Pen Recorders Data Loggers, Multichannel Loggers ..... P.19 -	Data Recorders Data Loggers
	Impedance Analyzers, LCR/Resistance Meters, Battery Testers, Super Megohm meters, DMM, Signal Generators/Calibrators ..... P.39 -	LCR / Resistance Meters
	Impulse/Surge Testers, Leakage Current Testers, Insulation Withstanding Testers, Protective Ground Testers ..... P.63 -	Safety Testing
	Power Meters, Power Analyzers, Power Quality Analyzers, Power Loggers ..... P.69 -	Power Meters
	Current Probes, Current Sensors ..... P.80 -	Current Sensors
	RGB LASER, LED, Optical Power Meters, PV Maintenance Testers, LAN Cable Testers ..... P.90 -	Optical / PM maintenance Telecommunication
	Magnetic Field, Temperature, Sound Level, Lux ..... P.94 -	Environmental Measuring
	Digital Multimeters (DMMs) Testers ..... P.97 -	DMM/ Testers Field Measuring
	Insulation Testers, Clamp Meters, Ground Resistance Testers, Phase Rotation Meters, Voltage Detectors ..... P.102 -	
	Meter Relays, CT, Shunts GENNECT Cross, WPT Test System ..... P.116 -	New Solutions Meter Relays
	ATE (Automatic Test Equipment) Bare Board & Package Testing, Populated Board Testing ..... P.121 -	Bare Board & Package Testing
■	Model No. (Order Code) Index ..... P.129 - Product Warranties ..... P.135 Repair and calibration service ..... P.136 JCSS and JCSS Calibration ..... P.136	Model No. Index / Other

## "Respect for Humanity" and "Contribution to Society".

To develop as a company, it is essential not only to create an environment in which every employee can make the most of his or her skills, but also to act as a good corporate citizen. Giving shape to this philosophy constitutes HIOKI's corporate social responsibility, and this philosophy serves as the backbone for everything we do.

### Providing High-quality Products and the Best Possible Service

Electrical measuring instruments, known as the "mother tools" of industry, play an essential support role in the development of technology. Hioki is committed to contributing to the development of all industries by continuing to provide high-quality products and the best possible service as a specialized manufacturer of electrical measuring instruments.

In addition to contributing to social good through the development, manufacture, and sale of electrical measuring instruments, Hioki actively supports environmental conservation activities and the development of culture and education in local communities. This focus reflects our awareness that we, too, are part of the communities in which we conduct our business activities.

Hioki is involved in a variety of community service initiatives, including the Ueda Minami League, a baseball program for area youth; the Hioki Festival, an annual event that is planned and orchestrated by Hioki employees for the enjoyment of local residents; and a series of public lectures by expert speakers on socially relevant topics. Other community-oriented initiatives in which Hioki is involved include scholarships for university students enrolled in science and technology programs and the Local Afforestation tree-planting program, both of which are administered by the Hioki Scholarship and Greening Foundation.

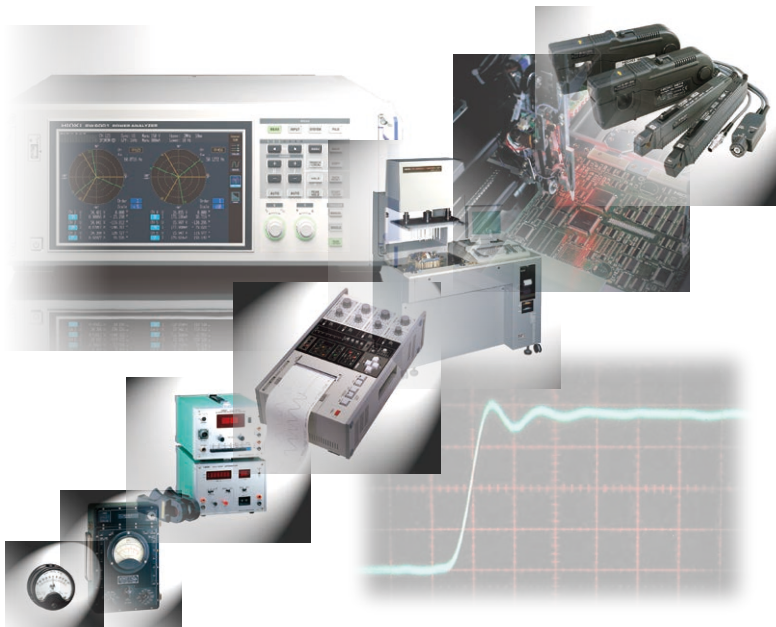

The HIOKI Innovation Center is equipped with some of the world's most advanced testing equipment.

Operated in May 2015

### Corporate History

#### 2021

- HIOKI (Shanghai) MEASURING INSTRUMENTS CO., LTD. is founded in China.
- Sakaki Factory is established.

#### 2020

- The Memory HiLogger LR8450 and LR8450-01 Quick Start Manual (Japanese) receives a "Manual of the Year 2020" at the 2020 Japan Manual Awards.

#### 2019

- The CM4376 receives an Honorable Mention Award at JECA Fair 2019.
- The CT6710 and CT6711 user manuals receive the Excellence Award and the Manual of the Year Award in the industry category at the 2019 Japan Manual Awards.
- The CT6877 receives a Selection Award at the JIDA Museum Selection Vol. 21.

#### 2018

- The MR6000 receives an internationally prestigious iF Design Award.

#### 2015

- HIOKI Innovation Center (research building) completed.

#### 2014

- Hioki PW3365 receives the Minister Prize of Land, Infrastructure, Transport and Tourism at the JECA (Japan Electrical Construction Association) Fair 2014.
- Hioki PW9020 receives 2014 Design for the Future Award (Good Design Special Award).

#### 2009

- HIOKI's main factory is recognized by the Prime Minister of Japan for distinguished service in promoting afforestation.

#### 2005

- The HIOKI Scholarship and Greening Foundation is established.

#### 2003

- HIOKI is listed on Section 1 of the Tokyo Stock Exchange.

#### 1994

- HIOKI launches high-frequency band current probes for use with oscilloscopes.

#### 1990

- The Head Office and main factory are relocated to a newly completed facility at HIOKI Forest Hills in Ueda, Nagano Prefecture.

#### 1987

- HIOKI enters the electronic component measuring instrument market by launching the LCR HiTESTER 3520.

#### 1986

- HIOKI enters the printed circuit board testing system market by launching the IN-CIRCUIT HiTESTER 1101, a board testing system.

#### 1983

- HIOKI launches the MEMORY HiRECORDER 8801, becoming the first company in the industry to bring to market an instrument that records data both on thermal paper and in built-in memory.

#### 1978

- Hioki launched the Clamp On Power Meter 3131, the first instrument of its kind in the industry, to promote energy efficiency during the 1970s oil crisis.

#### 1952

- The U.S. Air Force (Far East) contracts HIOKI to manufacture MIL-SPEC multi-testers for use in aircraft maintenance.
- HIOKI receives an order for a large number of TS-352A/u multitesters for use with aircraft.

#### 1935

- HIOKI starts manufacturing electrical indicating meters in Minato-ku, Tokyo.

# SDGs Initiatives

Hioki contributes to customers' activities and society in general through its products, services, and initiatives.

## Overview of the SDGs

SDGs, or Sustainable Development Goals, which were adopted at a United Nations summit in September 2015, comprise a set of shared, worldwide goals to be achieved by 2030. The SDGs, which consist of 169 targets across 17 goals, embody the philosophy of "leave no one behind."

At Hioki, we are working to give shape to the SDGs in keeping with the Hioki Philosophy of "Respect for Humanity" and "Contribution to Society." We believe that this philosophy dovetails with the core principles of the SDGs, and that we can contribute to the achievement of the SDGs by pursuing our own initiatives. Going forward, we will continue to work to contribute to both stakeholders and local communities through products, services, and initiatives that are designed to realize a sustainable society.



## Contributing to society through Hioki products and initiatives



**Affordable and clean energy**

Example product contribution

Supporting energy-saving activities with clamp-on power meters that can be used to check power usage



**Industry innovation and infrastructure**

Example product contribution

Supporting R&D, production, and testing of electric vehicles, electronic components, and batteries



**Sustainable cities and communities**

Example product contribution

Supporting safety and security in daily life with field measuring instruments



SDG content	Key initiatives
<p><b>Good health and well-being</b></p>	<ul style="list-style-type: none"> <li>Medical checkups</li> <li>Annual checkups (including for dependent family members and part-time employees)</li> <li>Health consultation and counseling</li> </ul>
<p><b>Quality education</b></p>	<ul style="list-style-type: none"> <li>Recitals and public talks</li> <li>Scholarship funds</li> <li>Internships • Self-development</li> <li>Global training for young employees</li> </ul>
<p><b>Gender quality</b></p>	<ul style="list-style-type: none"> <li>Female participation in the workforce</li> <li>Nursing care leave</li> <li>Support for child-raising and childcare leave</li> <li>Prevention of harassment (training and counseling programs)</li> </ul>
<p><b>Affordable and clean energy</b></p>	<ul style="list-style-type: none"> <li>Energy-saving activities (Reduction of energy consumption at Hioki sites)</li> <li>Solar power</li> </ul>
<p><b>Decent work and economic growth</b></p>	<ul style="list-style-type: none"> <li>Lifelong engagement with productive work through increases in the retirement age</li> <li>Paid time off for "brain development"</li> <li>Promotion of a healthy work-life balance</li> <li>Recreational events</li> </ul>
<p><b>Industry innovation and infrastructure</b></p>	<ul style="list-style-type: none"> <li>Kaizen activities (Ace 21)</li> <li>Three-year product warranties</li> <li>Free repairs of under-warranty products</li> </ul>
<p><b>Reduced inequalities</b></p>	<ul style="list-style-type: none"> <li>Employment of disabled individuals</li> </ul>

SDG content	Key initiatives
<p><b>Sustainable cities and communities</b></p>	<ul style="list-style-type: none"> <li>Hioki Festival</li> <li>Support for reconstruction in earthquake-struck areas</li> <li>Opening of social welfare facilities to the general public</li> <li>Parent-child company tours during summer vacation</li> <li>Support for youth baseball</li> <li>Support for the South Junior Sports Club</li> <li>Recycling initiatives</li> <li>Local clean-up activities</li> </ul>
<p><b>Responsible consumption and production</b></p>	<ul style="list-style-type: none"> <li>Use of renewable energy and green procurement</li> <li>Recycling initiatives</li> <li>Development of smaller products</li> </ul>
<p><b>Climate action</b></p>	<ul style="list-style-type: none"> <li>Reduction of CO<sub>2</sub> emissions</li> <li>Eco-drive initiatives</li> </ul>
<p><b>Life on land</b></p>	<ul style="list-style-type: none"> <li>Creating forests in local communities</li> <li>Tree-planting initiatives by overseas sales companies</li> </ul>
<p><b>Peace, justice and strong institutions</b></p>	<ul style="list-style-type: none"> <li>Compliance training</li> </ul>
<p><b>Partnerships for the goals</b></p>	<ul style="list-style-type: none"> <li>Support for Yokohama City University's Kenya Vegetation Restoration Project</li> </ul>

# About the Catalog

● This catalog is organized by product group. Search for products using the field-based (category-based) index on the first page. Products have been grouped using general names by principal application.

● A list of all available products can be found at the end of the catalog. The list is organized by product model and encompasses all products, including options.

● Options. Individual product pages include dedicated options. Options that are used by entire product groups are introduced together under the corresponding product group. For option specifications and other detailed information, please see the catalog for the product in question.

● Dimensions and mass. Exterior dimensions exclude protrusions, and are given in order of width(W), height(H), and depth(D), in mm units. Indicated weight represents an approximation of the mass of the main unit only, not including case, accessories, etc.

● Battery labeling. Battery labeling complies with IEC international standards and includes R6P (AA), R03 (AAA), 6F22 (9 V), LR6 (AA alkaline), LR03 (AAA alkaline), and CR2032 (button-cell lithium).

## 1 About the marks



Products that were released within 1 year from the publication date of this catalog



Products labeled as having a three-year warranty are covered for a period of three years from the date of purchase (or if the date of purchase is unknown, a period of three years from the date of manufacture). Accuracy is guaranteed for the duration of the separately indicated guaranteed accuracy period.



True RMS measuring capability for accurate measurement of even distorted waveforms.



Bluetooth® Supported interfaces



Trademark of SD-3C, LLC



\*Android, Google Play and the Google Play logo are trademarks of Google Inc.



\*iOS is a registered trademark of Cisco Technology, Inc. and/or its affiliates in the United States and certain other countries.

\*iPhone, iPad, iPad mini, iPod Pro and iPod touch are trademarks of Apple Inc.

\*Apple and the Apple logo are trademarks of Apple Inc. App Store is a service mark of Apple Inc.

\*Microsoft, Windows, Windows Vista, and Excel are either registered trademarks or trademarks of Microsoft Corporation in the United States and/or other countries.

\*Company names and Product names appearing in this catalog are trademarks or registered trademarks of various companies.

\*The Bluetooth® word mark and logos are registered trademarks owned by Bluetooth SIG, Inc. and any use of such marks by HIOKI E.E. CORPORATION is under license.

\*For the latest information about countries and regions where wireless operation is currently supported, please visit the Hioki website.



Use only when the measurement object is an insulated conductor.

## ISO 14001/ISO 9001 certified



### ISO14001

The HIOKI head office is certified under the ISO14001 international standard for environmental management systems.



### ISO9001

HIOKI's development, production, sales and service (repair and calibration) of electric measuring instruments are certified under the ISO9001 international standard for quality management and quality assurance.

\*For more information, please see the Hioki website.

## 2 Rectification Methods: True RMS and Mean

There are two methods for converting current into RMS values: the true RMS method (true RMS value indication) and the mean method (mean rectification RMS value indication). Although both methods yield the same value for undistorted sine waves, distortion of the waveform causes the values to diverge.

### True RMS RMS value method (true RMS value indication)

The waveform including harmonic components is calculated according to an RMS calculation formula and displayed.

### MEAN Mean method (mean rectification RMS value indication)

The input waveform is treated as an undistorted sine wave (single frequency only). The AC signal mean is calculated, converted to an RMS value, and displayed. The measurement error increases when the waveform is distorted.

\*Widespread use of equipment such as inverter devices and switching power supplies has made it more common for current waveforms being measured to be distorted. It is recommended to use a measuring instrument that uses the true RMS method to ensure accurate measurement.

■ Comparing distorted current values from an inverter, etc.

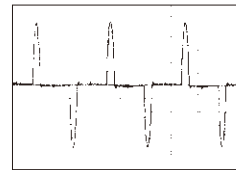

Current waveform from an inverter (primary side)

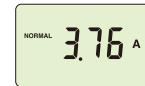

Mean-type clamp ammeter

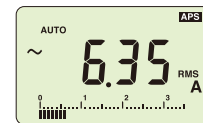

True RMS clamp ammeter

## 3 Accuracy and tolerances

### ● f.s. (maximum display, or length of scale, ...full-scale)

Signifies the maximum display (scale) value or the length of the scale (in cases where the scale consists of unequal increments or where the maximum value cannot be defined). In general, this is the range value (the value written on the range selector, or equivalent) currently in use. However, be aware that in cases where the maximum display value is 2000V but the range value is only 600V, the maximum display value (scale value) is still used as the f.s. value.



300V range

### ● rdg (displayed or indicated value, ... reading value)

This signifies the value actually being measured, i.e., the value that is currently indicated or displayed by the measuring instrument.



Measuring 100 V using the 300 V range

### ● dgt (digital resolution, ... digit)

Signifies the smallest display unit on a digital measuring instrument, i.e., the value displayed when the last digit on the digital display is "1". Essentially, this indicates an error of 1 digit (based on decimal processing in analog-to-digital conversion), but in actuality this is the digit error combined with the f.s. error converted to a fraction of a digit unit. The accuracy associated with a particular measured value as shown in the product specifications is derived from these values.

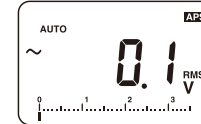

In the 300 V range, the 0.1 V digit is the smallest digit

### Example accuracy calculations

#### (Example accuracy calculation 1) (when the accuracy notation combines rdg and dgt)

Accuracy specification:  $\pm 1.0\% \text{ rdg} \pm 3 \text{ dgt}$   
 Measurement range: 300.0 V  
 Measured value: 100.0 V

Since the value being measured is 100.0 V:

- (A) Reading error ( $\pm\% \text{ rdg}$ ):  $\pm 1.0\%$  of 100.0 V =  $\pm 1.0$  V  
 (B) Digit error (dgt): Since the maximum resolution is 0.1 V,  $\pm 3 \text{ dgt} = \pm 0.3$  V  
 (C) Total error (A+B):  $\pm 1.3$  V

Based on the total error (C), the error boundary values for a measured value of 100.0 V would be **98.7 V to 101.3 V**.

#### (Example accuracy calculation 2) (when the accuracy notation combines rdg and f.s.)

Accuracy specification:  $\pm 0.2\% \text{ rdg} \pm 0.1\% \text{ f.s.}$   
 Measurement range: 300.00 V  
 Measured value: 100.00 V

Since the value being measured is 100.00 V:

- (A) Reading error ( $\pm\% \text{ rdg}$ ):  $\pm 0.2\%$  of 100.00 V =  $\pm 0.20$  V  
 (B) Full-scale error ( $\pm\% \text{ f.s.}$ ):  $\pm 0.1\%$  of 300 V =  $\pm 0.30$  V  
 (C) Total error (A+B):  $\pm 0.50$  V

Based on the total error (C), the error boundary values for a measured value of 100.00 V would be **99.50 V to 100.50 V**.

This Electrical Measuring Instruments General Catalog provides a product outline. For more detailed information, please refer to individual product catalogs and series catalogs, which group together similar products.

# Ensuring Safe Operation of the Product

To help you use measuring instruments safely, the following information is provided in each product's Instruction Manual under "Specifications":

- Rated voltage to ground: The measurement point's voltage level relative to ground, Measurement Category, Anticipated transient overvoltage, etc.
- Location for use: Pollution Degree 2, indoor, altitude no more than 2000 m, etc.

## 1 Measurement Category

Under safety standards (EN61010 Series, JIS C 1010 Series), measurement is classified into Categories II to IV according to the measurement point's rated voltage to ground, current capacity (size of current that flows in a short-circuit fault), etc., and the transient overvoltage that occurs at the measurement point.

- **Category II** Measurement at a point from the power plug to the equipment's power circuits, where equipment is directly connected to an outlet.
- **Category III** Measurement at a point on the power distribution cabling or power supply circuits, or at a point from the distribution panel to a distribution terminal behind an outlet, where equipment (for example a fixed installation) takes electricity directly from a distribution panel.
- **Category IV** Measurement at a point on a service drop to a building, or on the line from the drop connection to the power meter or distribution panel.

The measurement instrument's Category is marked as "CAT II", "CAT III" or "CAT IV" near the measurement terminals.

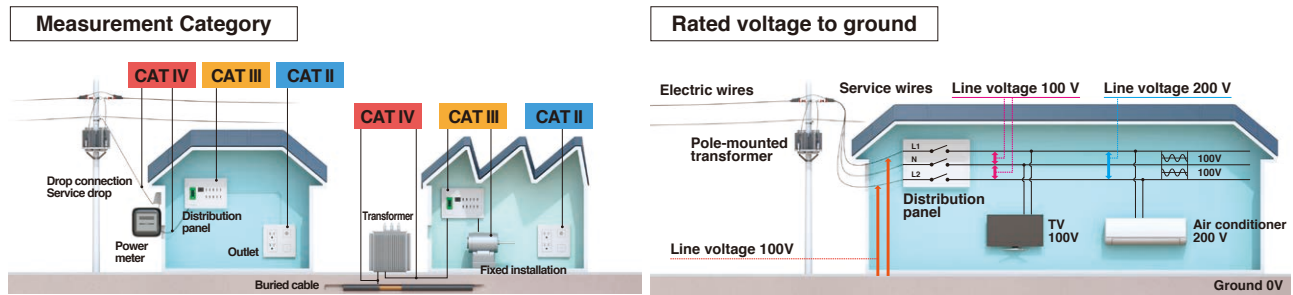

### How to read a category indication

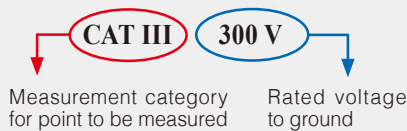

Three-phase three-wire (3P3W) system, 400 V line

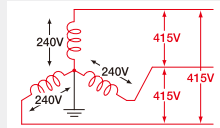

\* Voltage indications  
**Black:** Voltage to ground (including line-to-line voltage)  
**Red:** Line-to-line voltage

With the 400 V line in the figure, the line-to-line voltage is 415 V, whereas the voltage to ground is no more than 240 V (300 V).



Never measure a measurement point with a higher category number than the category indicated on the measuring instrument. Doing so could lead to a serious accident such as electric shock.

## 2 Anticipated Transient Overvoltage

Power lines in factories and similar facilities will at times include transient overvoltage (impulse voltage) that is around 10 times the power source voltage. The transient overvoltage of the measurement points must be predicted in advance, and the instrument will need a safety design that will enable it to withstand such overvoltage.

Safety standards stipulate values such as the following for transient overvoltage, according to the voltage to ground and the measurement category.

Assuming 600 V for the measurement point's voltage to ground, a Category IV location could potentially include transient overvoltage of 8000 V. Hence, CAT IV measurement instruments are designed to withstand transient overvoltage of 8000 V. CAT III measurement instruments can only withstand up to 6000 V, so if 8000 V transient overvoltage enters, it will cause insulation breakdown that could result in electric shock.

Rated voltage to ground [V]	Transient overvoltage [V]		
	CAT II	CAT III	CAT IV
300	2500	4000	6000
600	4000	6000	8000
1000	6000	8000	12000
1500	8000	10000	15000
2000	12000	15000	18000

## 3 Pollution Degrees

If contaminants adhere to the surfaces of a measuring instrument, its insulation performance will fall and it will pose a high risk of electric shock.

Safety standards classify environments where measuring instruments are used into Pollution Degrees 1 to 4.

- **Pollution Degree 1** Environment with no pollution, or with only dry contaminants present (non-conductive dirt, dust, etc.), which will not affect a measuring instrument's insulation performance.
- **Pollution Degree 2** Environment with only dry contaminants present (non-conductive dirt, dust, etc.), but where condensation could form on a measuring instrument, in which case the contaminants could cause a temporary drop in its insulation performance.
- **Pollution Degree 3** Environment with conductive contaminants present (water, soil, etc.), and which therefore could affect a measuring instrument's insulation performance, depending on how (much) contaminant adheres to it. Or, environment with high humidity, where even non-conductive contaminants could be a problem, since due to condensation a measuring instrument could have wet surfaces for relatively long periods.
- **Pollution Degree 4** Environment that could cause a prolonged drop in a measuring instrument's insulation performance, due to conductive contaminants (water, soil and the like) adhering to its surfaces, or to being wetted by rain.

A "Pollution Degree 2" marking on a measurement instrument means that it can be used without detriment to safety in environments of Pollution Degree 1 or 2 described above, and a "Pollution Degree 3" marking means the measurement instrument can be used in environments of Pollution Degrees 1 to 3.

## 4 Altitude

As altitude (elevation) rises, the air pressure decreases and flashover (breakdown and discharge through the air) becomes more likely to occur.

Accordingly, safety standards stipulate safety design that assumes use locations of altitude no more than 2000 m for measuring instruments.

If measuring instruments are used in locations of altitude exceeding 2000 m, the spaces between their parts that are under hazardous voltage and their parts that humans touch should be made larger as a precaution.

# Data Acquisition, Recorder, Data Logger Index

Portable Recorders for Servicing and Maintenance

Simultaneously Capture Multiple Signals at High Speeds

Monitor Anomalies in the Power Line

Category Index

Sampling speed	Number of channels			
	1ch	2ch	4ch	8ch 10ch 16ch
200MS/sec (5ns)				MEMORY HiCORDER MR8847A (16ch)
20MS/sec (50ns)				Instantaneous waveform/ RMS value recording ..... p.21
10MS/sec (100ns)		MEMORY HiCORDER MR8870 (2ch)	MEMORY HiCORDER MR8880 (4ch)	
1MS/sec (1µs) 400kS		Instantaneous waveform/ RMS value recording ..... p.20	Instantaneous waveform/ RMS value recording ..... p.19	
100kS/sec (10µs)				
10kS/sec (100µs)				Log Multiple Channels of
1kS/sec (1ms)				
100S/sec (10ms)		WIRELESS FUNGAL LOGGER LR8520	WIRELESS MINI LOGGER LR8512- LR8515	HEAT FLOW LOGGER LR8432 (10ch) MEMORY HiLOGGER LR8431 (10ch)
10S/sec (100ms)		Fungal index recording ..... p.29	Multi-signal recording ..... p.29-p.31	Heat flow/ DC/ Temperature/ Pulse measurement ..... p.31 DC/ Temperature/ Pulse measurement ..... p.35
1S/sec (1sec)	DATA LOGGERS LR 5000 series			
	Multi-signal recording ..... p.36-p.38			

## Non-contact AC Voltage Testing Non-contact CAN sensors

NON-CONTACT CAN SENSOR SP7001, SP7002  
NON-CONTACT AC VOLTAGE PROBE SP3000-01



- Supports  $\phi$ 1.2mm to 2.0mm covered wires
- No modification of vehicle cables
- No impact on the CAN bus or ECUs
- Accurate, reliable signal capture ..... p.24
- Supports  $\phi$ 1mm to 2.5mm covered wires
- 10Hz to 100kHz frequency bandwidth
- 5Vrms 14Vp-p rated measurement voltage ..... p.24

## Recorder Peripherals



- Connection cord
- PC card
- Logic probe
- Clamp on probe, etc ..... p.25-p.27

## PC Software for Data Management

MR6000 Viewer



- For Memory HiCorder MR6000. Available for download free of charge from Hioki's website. .... p.28

WAVE PROCESSOR 9335

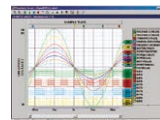

- For Memory HiCorder
- Convert data, print and display waveforms ..... p.28

LAN COMMUNICATOR 9333

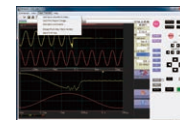

- For Memory HiCorder
- For data collection and remote control ..... p.28



## Multi-Channel Recorders

MEMORY HiCORDER  
MR6000 (16ch)



Instantaneous waveform/  
Long term recording  
..... p.19

MEMORY HiCORDER  
MR8741 (16ch)



Systems Integration  
..... p.23

MEMORY HiCORDER  
MR8827 (32ch)



Instantaneous waveform/  
RMS value recording  
..... p.21

MEMORY HiCORDER  
MR8740 (54ch)



Ideal for rack-mounting  
..... p.23

MEMORY HiCORDER  
MR8740T (108ch)



Ideal for rack-mounting  
..... p.22

MEMORY HiCORDER  
MR8875 (16ch)



Instantaneous waveform/  
Temperature/Pulse/CAN  
signal measurement  
..... p.20

MEMORY HiCORDER  
MR6000 (32ch)



Instantaneous waveform/  
Long term recording  
..... p.19

MEMORY HiCORDER  
MR6000 (Logic128ch)



Instantaneous waveform/  
Long term recording  
..... p.19

## Temperature, Voltage and More

MEMORY HiLOGGER  
LR8450 (20ch)



DC/ Temperature/ Pulse  
measurement  
..... p.33

MEMORY HiLOGGER  
LR8450-01 (55ch)



DC/ Temperature/ Pulse  
measurement  
..... p.33

MEMORY HiCORDER  
MR8875 (60ch)



Temperature measurement  
..... p.20

MEMORY HiLOGGER  
LR8450 (120ch)



DC/ Temperature/ Pulse  
measurement  
..... p.33

MEMORY HiLOGGER  
8423 (120ch)

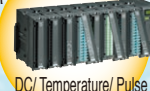

DC/ Temperature/ Pulse  
measurement  
..... p.35

MEMORY HiLOGGER  
LR8450-01 (330ch)



DC/ Temperature/ Pulse  
measurement  
..... p.33

WIRELESS LOGGING STATION  
LR8410 (15ch)



DC/ Temperature/ Pulse  
measurement  
..... p.32

WIRELESS LOGGING STATION  
LR8410 (105ch)



DC/ Temperature mea-  
surement  
..... p.32

MEMORY HiLOGGER  
8423 (600ch)



DC/ Temperature/ Pulse  
measurement  
..... p.35

16ch

30ch

32ch

60ch

64ch

120ch

128ch

...600ch

Number of channels

### Other compatible software (third party)

FlexPro



- Powerful data analysis and presentation software for importing and organizing data from the MEMORY HiCORDER Series
- From Weisang GmbH (Germany)  
..... p.28

## Monitor Power Demand and Equipment Efficiency

### CLAMP ON POWER LOGGER PW3365



- Designed for 50/60 Hz commercial line use
  - 3 circuits (1P2W), single circuit (1P3W, 3P3W, 3P4W)
  - Save data to SD card continuously
  - (Current) Clamp input
  - (Voltage) Non-metallic contact sensor
- ..... p.77

### CLAMP ON POWER LOGGER PW3360



- Designed for 50/60 Hz commercial line use
  - 3 circuits (1P2W), single circuit (1P3W, 3P3W, 3P4W)
  - Save data to SD card continuously
  - Clamp input
  - Harmonic analysis
- ..... p.78

## Peripherals for Compact Loggers

### DATA COLLECTOR LR5092 COMMUNICATION ADAPTER LR5091



- Used with the LR5000 series
  - Transfer data from LR5000s to the PC
  - Transfer setting/clock data from PC to the LR5000s
  - Free bundled software
  - USB interface
- ..... p.36

## Compact Temperature or Humidity Loggers

### WIRELESS FUNGAL LOGGER LR8520



- Record fungal index, growth prediction, temperature and humidity
  - Minimum 0.5 sec interval
  - Wireless data download to a tablet or computer
  - 500,000 data/ ch
  - Alarm output
  - Three-way power
- ..... p.29

### WIRELESS VOLTAGE/TEMP LOGGER LR8515



- 2 ch Voltage ( $\pm 50$  mV to  $\pm 50$  V) Thermocouple recording
  - Minimum 0.1 sec interval
  - Wireless data download to a tablet or computer
  - 500,000 data/ ch
  - Three-way power
- ..... p.29

### WIRELESS HUMIDITY LOGGER LR8514



- 2 ch Temperature/ 2 ch Humidity recording
  - -40 to 80 °C/ 0 to 100 % RH (with optional sensor)
  - Fastest 1 sec interval
  - Minimum 0.5 sec interval
  - Wireless data download to a tablet or computer
  - 500,000 data/ ch
  - Three-way power
- ..... p.30

### TEMPERATURE LOGGER LR5011



- 1 ch Temperature recording
  - -40 °C to 180 °C (with optional sensor)
  - Fastest 1 sec interval
  - 60000 data  $\times$  1ch memory
  - Dry cell battery operation
  - IP54 (splash-proof)
- ..... p.38

### HUMIDITY LOGGER LR5001



- 2 ch Temperature / Humidity alternating recording
  - -40 °C to 85 °C/ 0 to 100 %rh (with LR9504 sensor)
  - Fastest 1 sec interval
  - 60000 data  $\times$  2ch memory
  - Dry cell battery operation
  - IP54 (splash-proof)
- ..... p.38

## Pulse integration (flow rate, vehicle speed, etc.)

### WIRELESS PULSE LOGGER LR8512



- 2 ch Pulse totalization/ No. of revolutions/ Logic recording
  - Fastest 0.1 sec interval
  - Wireless data download to a tablet or computer
  - 500,000 data/ ch
  - Three-way power
- ..... p.31

## Compact Current Loggers

### WIRELESS CLAMP LOGGER LR8513



- AC/DC load current, AC leakage current recording
  - 2ch, Clamp-on sensor input
  - Fastest 0.5 sec interval
  - Wireless data download to a tablet or computer
  - 500,000 data/ ch
  - Three-way power
- ..... p.30

### CLAMP LOGGER LR5051



- 2ch AC current recording (with optional sensor)
  - 0 to 1000 A AC
  - Fastest 1 sec interval
  - 60000 data  $\times$  2ch memory
  - Dry cell battery operation
- ..... p.36

### WIRELESS VOLTAGE/TEMP LOGGER LR8515



- 2 ch Voltage ( $\pm 50$  mV to  $\pm 50$  V) Thermocouple recording
  - Minimum 0.1 sec interval
  - Wireless data download to a tablet or computer
  - 500,000 data/ ch
  - Three-way power
- ..... p.29

## Compact DC Voltage Loggers

### VOLTAGE LOGGER LR5041, LR5042, LR5043



- 1ch DC voltage recording
  - LR5041:  $\pm 50$  mV DC
  - LR5042:  $\pm 5$  V DC
  - LR5043:  $\pm 50$  V DC
  - Minimum 1 sec interval
  - 60000 data  $\times$  1ch memory
  - Dry cell battery operation
  - IP54 (splash-proof)
- ..... p.37

## Instrumentation recording

### INSTRUMENTATION LOGGER LR5031



- 1 ch 0 to 20mA recording
  - Minimum 1 sec interval
  - 60000 data  $\times$  1ch memory
  - Dry cell battery operation
  - IP54 (splash-proof)
- ..... p.37

## For analysis of LiB electrode slurries

### Slurry Analytical System



- Impedance measurement and analysis of LiB electrode slurries
  - Analysis Results "DCR, Ratio, Uniformity" indicate electron conductivity of Slurry
- ..... p.51

## For evaluation of LiB electrode sheets

### ELECTRODE RESISTANCE MEASUREMENT SYSTEM RM2610



- Isolates and quantifies composite layer resistance and interface resistance in positive- and negative-electrode sheets used in lithium-ion batteries.
- ..... p.51

## Battery Testing

### BATTERY INSULATION TESTER BT5525



- Ideal for insulation resistance testing before battery electrolyte filling
  - Detecting minuscule insulation defects caused by contamination (Break Down Detect function)
  - Test voltage: 500 V max.
  - Insulation resistance test: up to 9999 M $\Omega$
  - Contact check
- ..... p.66

### BATTERY TESTER BT3561A



- Compact power cells
  - Compact packs up to 60 V
  - AC 4-terminal method
  - Resistance measurement: 0  $\Omega$  to 3.1 k $\Omega$  (maximum resolution: 1  $\mu\Omega$ )
  - Voltage measurement: 0 V to  $\pm 60$  V DC (maximum resolution: 10  $\mu$ V)
- ..... p.53

### BATTERY TESTER BT3562A



- Large cells for xEVs
  - Medium-size packs up to 100 V
  - AC 4-terminal method
  - Resistance measurement: 0  $\Omega$  to 3.1 k $\Omega$  (maximum resolution: 0.1  $\mu\Omega$ )
  - Voltage measurement: 0 V to  $\pm 100$  V DC (maximum resolution: 10  $\mu$ V)
- ..... p.53

### BATTERY TESTER BT3563A









- Large packs for xEVs
  - Large packs up to 300 V
  - AC 4-terminal method
  - Resistance measurement: 0  $\Omega$  to 3.1 k $\Omega$  (maximum resolution: 0.1  $\mu\Omega$ )
  - Voltage measurement: 0 V to  $\pm 300$  V DC (maximum resolution: 10  $\mu$ V)
- ..... p.54

### BATTERY TESTER BT3554-50





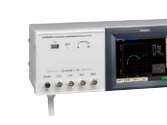



- Diagnose deterioration and health of UPS, compact and large lead-acid batteries
  - Testing source: AC 1kHz
  - Finest resolution: 1  $\mu\Omega$
  - Compatible with Wireless Adapter Z3210
- ..... p.57



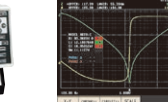

## Impedance, Inductance and Capacitance in Research and Development and During Component Production

<b>IMPEDANCE ANALYZER IM7587</b>  <ul style="list-style-type: none"> <li>•  Z , L, C, R testing</li> <li>• Testing source frequency: 1 MHz to 3 GHz</li> <li>• Measuring time: 0.5 ms</li> <li>• Measure LCR and conduct frequency sweeps simultaneously</li> </ul> <p>..... p.39</p>	<b>IMPEDANCE ANALYZER IM7585</b>  <ul style="list-style-type: none"> <li>•  Z , L, C, R testing</li> <li>• Testing source frequency: 1 MHz to 1.3 GHz</li> <li>• Measuring time: 0.5 ms</li> <li>• Measure LCR and conduct frequency sweeps simultaneously</li> </ul> <p>..... p.40</p>	<b>IMPEDANCE ANALYZER IM7583</b>  <ul style="list-style-type: none"> <li>•  Z , L, C, R testing</li> <li>• Testing source frequency: 1 MHz to 600 MHz</li> <li>• Measuring time: 0.5 ms</li> <li>• Measure LCR and conduct frequency sweeps simultaneously</li> </ul> <p>..... p.40</p>	<b>IMPEDANCE ANALYZER IM7581</b>  <ul style="list-style-type: none"> <li>•  Z , L, C, R testing</li> <li>• Testing source frequency: 100 kHz to 300 MHz</li> <li>• Measuring time: 0.5 ms</li> <li>• Measure LCR and conduct frequency sweeps simultaneously</li> </ul> <p>..... p.41</p>	<b>IMPEDANCE ANALYZER IM7580A</b>  <ul style="list-style-type: none"> <li>•  Z , L, C, R testing</li> <li>• Testing source frequency: 1 MHz to 300 MHz</li> <li>• Measuring time: 0.5 ms</li> <li>• Measure LCR and conduct frequency sweeps simultaneously</li> </ul> <p>..... p.41</p>	<b>CHEMICAL IMPEDANCE ANALYZER IM3590</b>  <ul style="list-style-type: none"> <li>•  Z , L, C, R, <math>\sigma</math> (conductivity), <math>\epsilon</math> (dielectric constant) testing</li> <li>• Battery measurement</li> <li>• Testing source frequency: 1 MHz to 200 kHz</li> <li>• Measuring time: 2 ms</li> </ul> <p>..... p.42</p>	<b>IMPEDANCE ANALYZER IM3570</b>  <ul style="list-style-type: none"> <li>•  Z , L, C, R testing</li> <li>• Testing source frequency: 4 Hz to 5 MHz</li> <li>• Measuring time: 0.5 ms</li> <li>• Measure LCR and conduct frequency sweeps simultaneously</li> </ul> <p>..... p.43</p>
--	--	--	--	--	--	---

## Impedance, Inductance and Capacitance Testing During Component Production

<b>LCR METER IM3536</b>  <ul style="list-style-type: none"> <li>•  Z , L, C, R testing</li> <li>• Testing source frequency: DC, or 4 Hz to 8 MHz</li> <li>• Measuring time: 1 ms</li> <li>• Accuracy guaranteed range from 1m<math>\Omega</math></li> <li>• Continuous testing under varying conditions</li> </ul> <p>..... p.44</p>	<b>LCR METER IM3533</b>  <ul style="list-style-type: none"> <li>•  Z , L, C, R testing</li> <li>• Testing source frequency: 1 MHz to 200 kHz</li> <li>• Measuring time: 2 ms</li> <li>• Transformer measurement mode</li> <li>• Frequency sweep measurement: (IM3533-01)</li> </ul> <p>..... p.45</p>	<b>LCR METER IM3523, IM3523A</b>  <ul style="list-style-type: none"> <li>•  Z , L, C, R testing</li> <li>• Testing source frequency: 40 Hz to 200 kHz</li> <li>• Measuring time: 2 ms</li> <li>• IM3523A: USB and LAN as standard</li> </ul> <p>..... p.44</p>	<b>LCR HiTESTER 3511-50</b>  <ul style="list-style-type: none"> <li>•  Z , L, C, R testing</li> <li>• Testing source frequency: 120 Hz or 1 kHz</li> <li>• Measuring time: 5 ms</li> </ul> <p>..... p.45</p>	<b>C METER 3506-10</b>  <ul style="list-style-type: none"> <li>• C, D, Q, low capacitance testing</li> <li>• Testing source frequency: 1 kHz, 1 MHz</li> <li>• Measuring time: 1.5 ms (1 MHz)</li> <li>• RS-232C, GP-IB</li> </ul> <p>..... p.46</p>	<b>C HiTESTER 3504</b>  <ul style="list-style-type: none"> <li>• C, D, large capacitance MLCC testing</li> <li>• Testing source frequency: 120 Hz or 1 kHz</li> <li>• Measuring time: 2 ms</li> <li>• RS-232C standard (3504-50) BIN function, GP-IB</li> <li>• (3504-60) BIN function, Contact check, GP-IB</li> </ul> <p>..... p.46</p>	<b>EQUIVALENT CIRCUIT ANALYSIS FIRMWARE IM9000</b>  <ul style="list-style-type: none"> <li>• Optional software built in to the IM3570</li> <li>• Equivalent five circuit models</li> <li>• Enables displaying the ideal frequency characteristics graph derived from the analysis results</li> <li>• Cole-Cole plot, Admittance circle display</li> </ul> <p>..... p.43</p>
---	--	---	---	--	--	--

## DC Resistance Testing

<b>RESISTANCE METER RM3548</b>  <ul style="list-style-type: none"> <li>• High-precision portable resistance meter measures from <math>\mu\Omega</math> to M<math>\Omega</math></li> <li>• Testing source current: DC, 1 A Max.</li> <li>• Display refresh rate: approx. 100 ms</li> <li>• Finest resolution: 0.1 <math>\mu\Omega</math></li> </ul> <p>..... p.48</p>	<b>RESISTANCE METER RM3545</b>  <ul style="list-style-type: none"> <li>• Featuring super-high accuracy and multi-channel capabilities</li> <li>• Testing source: DC, 1 A max</li> <li>• Fastest measurement speed: 2.2ms</li> <li>• Finest resolution: 0.01 <math>\mu\Omega</math></li> <li>• Multi-point measurement: 20 locations</li> </ul> <p>..... p.48</p>	<b>RESISTANCE METER RM3544</b>  <ul style="list-style-type: none"> <li>• High-precision bench-top resistance meter for both manual operation and integration with automatic lines</li> <li>• Testing source current: DC, 300 mA Max.</li> <li>• Fastest measurement speed: 18 ms</li> <li>• Finest resolution: 1 <math>\mu\Omega</math></li> </ul> <p>..... p.49</p>	<b>RESISTANCE HiTESTER RM3543</b>  <ul style="list-style-type: none"> <li>• Advanced enough to measure 0.1 m<math>\Omega</math> shunts with room to spare</li> <li>• Ideal high precision &amp; high resolution for automated lines</li> <li>• Testing source: DC 1 A max.</li> <li>• Minimum integration time: 0.1 ms</li> <li>• Finest resolution: 0.01 <math>\mu\Omega</math></li> </ul> <p>..... p.49</p>	<b>RESISTANCE METER RM3542A, RM3542</b>  <ul style="list-style-type: none"> <li>• High-speed resistance meter ideal for automated lines</li> <li>• Compatible with super-small electronic components (RM3542A)</li> <li>• Testing source: DC, 100 mA max.</li> <li>• Fastest measurement time: 0.9 ms</li> <li>• Minimum integration time: 0.1 ms</li> <li>• Finest resolution: 0.1 <math>\mu\Omega</math></li> </ul> <p>..... p.50</p>
---	---	---	--	---







## Probes and Test Fixtures



- Probes and test fixtures for lead components
- Test fixtures for SMDs
- DUT size reference table included

..... p.47

## Battery Testing

<b>BATTERY CELL VOLTAGE GENERATOR SS7081-50</b>  <ul style="list-style-type: none"> <li>• Easily build a BMS evaluation environment</li> <li>• Power supply, electronic load, DMM function integrated into one (12 channels)</li> <li>• Generated voltage: 5V / ch</li> </ul> <p>..... p.52</p>	<b>SWITCH MAINFRAME SW1001, SW1002</b>  <ul style="list-style-type: none"> <li>• Pair with a measuring instrument to achieve multi-channel capabilities</li> <li>• SW1001: max. 66 channels (2-wire) to max. 18 channels (4-terminal pair)</li> <li>• SW1002: max. 264 channels (2-wire) to max. 72 channels (4-terminal pair)</li> </ul> <p>..... p.52</p>	<b>PRECISION DC VOLTMETER DM7275, DM7276</b>  <ul style="list-style-type: none"> <li>• DC V only</li> <li>• Measure DC voltage and temperature simultaneously</li> <li>• 7-1/2 digit resolution</li> <li>• 1-year 20ppm Accuracy (DM7275)</li> <li>• 1-year 9ppm Accuracy (DM7276)</li> <li>• Built-in EXT I/O, LAN, and USB</li> </ul> <p>..... p.61</p>	<b>BATTERY HiTESTER BT3564</b>  <ul style="list-style-type: none"> <li>• EV and PHEV battery pack testing</li> <li>• Testing source: AC 1kHz</li> <li>• Measure voltage up to 1000V</li> <li>• Measurement time: 728 ms</li> <li>• Finest resolution: 0.1<math>\mu\Omega</math> and 10<math>\mu\text{V}</math></li> </ul> <p>..... p.54</p>	<b>BATTERY HiTESTER BT3562-01, BT3563-01</b>  <ul style="list-style-type: none"> <li>• The perfect battery tester for production lines</li> <li>• Testing source: AC 1kHz</li> <li>• Max. voltage: 60 V DC (BT3562-01) 300 V DC (BT3563-01)</li> <li>• Measurement time: 18ms</li> <li>• Finest resolution: 0.1<math>\mu\Omega</math> and 10<math>\mu\text{V}</math></li> </ul> <p>..... p.55</p>	<b>BATTERY HiTESTER 3561</b>  <ul style="list-style-type: none"> <li>• The perfect battery tester for small secondary batteries</li> <li>• Testing source: AC 1kHz</li> <li>• Measurement time: 10ms</li> <li>• Finest resolution: 0.01m<math>\Omega</math></li> </ul> <p>..... p.55</p>	<b>BATTERY IMPEDANCE METER BT4560</b>  <ul style="list-style-type: none"> <li>• For Li-ion battery testing</li> <li>• Low-frequency AC-IR method without charge and discharge</li> <li>• R, X, Z, <math>\theta</math> measurement</li> <li>• Testing source from 0.1 Hz</li> <li>• Testing source current: 1.5 Arms</li> <li>• Measuring range at least 3 m<math>\Omega</math></li> <li>• DCV measurement with 10 <math>\mu\text{V}</math> resolution</li> </ul> <p>..... p.56</p>
--	--	--	--	---	---	---

## Super Insulation Testing of Capacitors

SUPER MΩ HITESTER SM7810    POWER SOURCE UNIT SM7860 series    SUPER MEGOHM METER SM7420    SUPER MEGOHM METER SM7110, SM7120



- For testing leakage current in MLCC
- 6.8ms measurement speed over 8ch simultaneously
- Testing current is applied externally
- Resistance measurement: Max.  $1 \times 10^9 \Omega$
- Current measurement: 1pA to 1mA ..... p.58
- Specially designed power source unit for SM7810
- Supports multi-channel systems and provides functions required for MLCC test lines
- 50 mA per channel output ..... p.58
- Fastest speed of 6.4 ms
- 4ch
- Dedicated micro current measurement (cannot generate or measure voltage)
- Max.  $2 \times 10^9 \Omega$  display
- Min. 0.1 fA resolution ..... p.59
- Fastest speed of 6.4 ms
- 1ch
- Max. 2000 V output (SM7120)
- Max. 1000 V output (SM7110)
- Max.  $2 \times 10^9 \Omega$  display
- Min. 0.1 fA resolution ..... p.59

## Peripherals

SURFACE/VOLUME RESISTANCE MEASUREMENT ELECTRODE SM9001

Testing terminals for super megohm measurement



- Simple and Convenient Surface/Volume Resistance Measurement (up to  $10^9 \Omega$ , 1000V)
- Measure surface and volume resistance of entire sheets without need to cut samples ..... p.60
- For flat plate testing
- For surface resistance testing
- For liquid testing
- Screen box
- Comparing resistance box ..... p.60

## System Integrated Digital Multi-Module Stations

DMM STATION U8991+MR8740T

DMM STATION MR8990+MR8741

DMM STATION MR8990+MR8740



- Store entire data from 108 units of DMM in single operation
- Simultaneous 108 ch sampling without signal scanner
- High  $\pm 0.02\%$  precision & ultra high 6-1/2 digit resolution
- 50 times/s sampling ..... p.61
- Store entire data from 16 units of DMM in single operation
- Simultaneous 16 ch sampling without signal scanner
- High  $\pm 0.01\%$  precision & ultra high 6-1/2 digit resolution
- 500 times/s sampling ..... p.61
- Store entire data from 54 units of DMM in single operation
- Simultaneous 32 ch sampling without signal scanner
- High  $\pm 0.01\%$  precision & ultra high 6-1/2 digit resolution
- 500 times/s sampling ..... p.61

## Benchtop Multimeters for Production and Inspection Lines

PRECISION DC VOLTMETER DM7275, DM7276



- DC V only
- Measure DC voltage and temperature simultaneously
- 7-1/2 digit resolution
- 1-year 9ppm Accuracy (DM7276)
- 1-year 20ppm Accuracy (DM7275)
- Built-in EXT I/O, LAN, and USB ..... p.61

## Arbitrary Waveform Generation Recorders

VIR GENERATOR UNIT U8794+MR8740T

ARBITRARY WAVEFORM GENERATION RECORDER U8793+MR8847A

ARBITRARY WAVEFORM GENERATION RECORDER U8793+MR8827

ARBITRARY WAVEFORM GENERATION RECORDER U8793+MR8741

ARBITRARY WAVEFORM GENERATION RECORDER U8793+MR8740

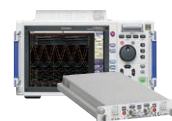

- DC voltage output
- DC current output
- resistance output (simulated resistance)
- 8ch ..... p.62
- Max. 2 MHz D/A output Arbitrary Waveform Generation function
- 10 mHz to 100 kHz Function Generator
- 20M-Sampling/s
- Max. 15V output
- Max. 16ch ..... p.62
- Max. 2 MHz D/A output Arbitrary Waveform Generation function
- 10 mHz to 100 kHz Function Generator
- 20M-Sampling/s
- Max. 15V output
- Max. 32ch ..... p.62
- Max. 2 MHz D/A output Arbitrary Waveform Generation function
- 10 mHz to 100 kHz Function Generator
- 20M-Sampling/s
- Max. 15V output
- Max. 16ch ..... p.62
- Max. 2 MHz D/A output Arbitrary Waveform Generation function
- 10 mHz to 100 kHz Function Generator
- 20M-Sampling/s
- Max. 15V output
- Max. 54ch ..... p.62

## Signal Generators and Calibrators

DC SIGNAL SOURCE SS7012



- DC constant voltage, constant current source
- $\pm 25 \text{ V}$ ,  $\pm 25 \text{ mA}$
- Thermoelectric power generation, K, E, J, T, R, S, B, N thermocouple
- DC voltage, DC current measurement
- Battery operation ..... p.62

## For Motor Winding Inspection

### IMPULSE WINDING TESTER ST4030A



- Diagnose winding quality and insulation while the rotor is assembled
  - Identify single-turn faults
  - Detect partial discharge with high accuracy
  - Diagnose insulation failure between motor windings
  - Output voltage up to 4200 V
- ..... p.63

### DISCHARGE DETECTION UPGRADE ST9000

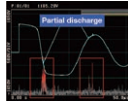

- Optional function for ST4030A
  - Detect microscopic partial discharges obscured by noise
  - HIOKI original filter
- ..... p.63

## Insulation Resistance and Withstand Voltage Testing

### AC AUTOMATIC INSULATION/ WITHSTANDING HIESTER 3174



- Insulation resistance test: up to 2000 MΩ
  - Withstanding voltage test: up to 5 kV AC
  - Contact check
  - Full remote control
- ..... p.67

### AUTOMATIC INSULATION/ WITHSTANDING HIESTER 3153



- Insulation resistance test: up to 9999 MΩ
  - Withstanding voltage test: up to 5 kV AC/DC
  - Full remote control
- ..... p.67

### HIGH VOLTAGE SCANNER 3930



- Supports remote control
  - For automatic multipoint testing of insulation / withstand voltage
  - Use with 3153's program or with general-purpose logic sequencers
- ..... p.65

## PC Applications

### SAFETY TEST DATA MANAGEMENT SOFTWARE 9267



- PC-controlled application software
- ..... p.65

## Leakage Current Testing in Equipment and Medical Devices

### LEAK CURRENT HIESTER ST5540



- Test both medical- and general-use electrical devices
  - Built-in support for all networks
  - Support for rated currents of up to 20 A
  - Support for automatic testing on production lines, etc.
- ..... p.64

### LEAK CURRENT HIESTER ST5541



- Testing of general-use electrical devices
  - Built-in support for networks other than medical-use electrical devices
  - Support for rated currents of up to 20 A
  - Support for automatic testing on production lines, etc.
- ..... p.64

## Insulation Resistance and Withstand Voltage Testing

### BATTERY INSULATION TESTER BT5525



- Ideal for insulation resistance testing before battery electrolyte filling
  - Detecting minuscule insulation defects caused by contamination (Break Down Detect function)
  - Test voltage: 500 V max.
  - Insulation resistance test: up to 9999 MΩ
  - Contact check
- ..... p.66

### INSULATION TESTER ST5520



- Rapid 50ms testing speed
  - Test voltage: 1000 V max.
  - Insulation resistance test: up to 9999 MΩ
  - Contact check
- ..... p.66

## AC Ground Bond Testing

### AC GROUNDING HIESTER 3157



- Protective ground tester indispensable for standard certification (low resistance measure)
  - 0 to 1.8Ω measurement
  - Testing current up to 31A
- ..... p.68

## Evaluate and Analyze the Power Efficiency of Motors, Equipment and other Energy Saving Devices

**POWER ANALYZER PW8001**



- Max. 32 ch by synchronizing four 8-channel models
- For total evaluation of equipment
- Wide-band DC, 0.1 Hz to 5 MHz (U7005)
- DC, or 1P2W to 3P4W
- 8 ch/ current sensor input
- Measure inverter equipment, analyze motors and high frequency reactors
- Analyze waveforms without an oscilloscope

p.69

**POWER ANALYZER PW6001**



- Max. 12 ch by synchronizing two 6-channel models
- For total evaluation of equipment
- Wide-band DC, 0.1 Hz to 2 MHz
- DC, or 1P2W to 3P4W
- 6 ch/ current sensor input
- Measure inverter equipment and analyze motors
- Analyze waveforms without an oscilloscope

p.70

**POWER ANALYZER PW3390**



- Max. 32ch by synchronizing eight 4-channel models
- For total evaluation of equipment
- Wide-band DC, 0.5Hz to 200 kHz
- DC, or 1P2W to 3P4W
- 4 ch/ current sensor input
- Measure inverter equipment and analyze motors

p.71

**AC/DC CURRENT BOX PW9100A**



- Direct current measurement option for PW8001/PW6001/PW3390
- Wide-band DC to 3.5MHz, 50A
- AC/DC rated input, 0.04V/A output
- PW9100A-3 : 3 channels
- PW9100A-4 : 4 channels

p.72

**AC/DC HIGH VOLTAGE DIVIDER VT1005**



- Voltage measurement option for PW8001/PW6001/PW3390
- Divides high voltage by 1000:1 and outputs
- Wide-band DC to 4 MHz
- Measurement Accuracy: ±0.08% (DC) ±0.04% (50/60 Hz) ±0.17% (50 kHz)

p.71

## 3-Phase Power Meters for Industrial Equipment Testing

**POWER METER PW3337**



- 3 ch input, DC, or 1P2W to 3P3W, or 3P4W
- Max. input 1000 V, 65 A
- DC, or 0.1 Hz to 100 kHz
- ±0.1 % basic accuracy
- Direct input or clamp input

p.73

**POWER METER PW3336**



- 2 ch input, DC, or 1P2W to 3P3W
- Max. input 1000 V, 65 A
- DC, or 0.1 Hz to 100 kHz
- ±0.1 % basic accuracy
- Direct input or clamp input

p.73

## Single-Phase Power Meters for Industrial Equipment Testing

**POWER METER PW3335**



- Ultra-sensitive standby power measurement
- Measure according to IEC 62301
- DC, or 1P2W
- Max. input 1000 V, 30 A
- DC, or 0.1 Hz to 100 kHz
- ±0.1% basic accuracy
- Direct or clamp input

p.74

**AC/DC POWER HITESTER 3334**



- Compliant with the SPECpower® Benchmark
- DC, or 1P2W
- Max. input 300 V, 30 A
- DC, or 45 Hz to 5 kHz
- ±0.2% basic accuracy
- Guaranteed accuracy of 3 Years ±0.3 %
- Direct input only

p.75

**POWER HITESTER 3333**



- Space-saving footprint
- High accuracy of ±0.2 %
- 1P2W only
- Max. input 300 V, 30 A
- 45 Hz to 5 kHz
- Guaranteed accuracy of ±0.3% for 3 years
- Direct input only

p.75

## Monitor and Record Power Quality

**POWER QUALITY ANALYZER PQ3198**



- IEC61000-4-30 Ed.3 Class A Power Quality Analyzer
- Monitor and record the quality of power
- 1P2W to 3P4W, DC/ 50/ 60/ 400 Hz
- Clamp input

p.76

**POWER QUALITY ANALYZER PQ3100**



- IEC61000-4-30 Ed.3 Class S Power Quality Analyzer
- Monitor and record the quality of power
- 1P2W to 3P4W, DC/ 50/ 60 Hz
- Clamp input

p.76

## Monitor Energy Consumption and Analyze Energy Savings

**CLAMP ON POWER LOGGER PW3365**



- Designed for 50/60 Hz commercial line use
- 3 circuits (1P2W), single circuit (1P3W, 3P3W, 3P4W)
- Save data to the SD card continuously
- (Current) Clamp input
- (Voltage) Non-metallic contact sensor

p.77

**CLAMP ON POWER LOGGER PW3360**



- Designed for 50/60 Hz commercial line use
- 3 circuits (1P2W), single circuit (1P3W, 3P3W, 3P4W)
- Save data to the SD card continuously
- Clamp input
- Harmonic analysis

p.78

**POWER LOGGER VIEWER SF1001**

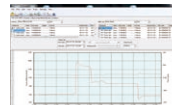

- Easy graphical processing of measurement data saved with the PW3360/3365 series, 3169 series on a PC

## Handheld Power Meter

**AC CLAMP POWER METER CM3286-50**



- Easy AC power checker
- Single-phase, 3-phase (balanced condition/without distortion)
- Phase angle, power factor
- Voltage/current harmonics (with Z3210 installed)
- AC clamp, True RMS, Battery operation
- Compatible with Wireless Adapter Z3210

p.79

## Non-contact AC Voltage Testing Non-contact CAN sensors

**NON-CONTACT CAN SENSOR**  
SP7001, SP7002



- Supports  $\phi$  1.2mm to 2.0mm covered wires
- No modification of vehicle cables
- No impact on the CAN bus or ECUs
- Accurate, reliable signal capture ..... p.24

**NON-CONTACT AC VOLTAGE PROBE**  
SP3000-01



- Supports  $\phi$  1mm to 2.5mm covered wires
- 10Hz to 100kHz frequency bandwidth
- 5Vrms 14Vp-p rated measurement voltage ..... p.24

## Current Probes to Observe DC to MHz Bandwidth Waveforms on Oscilloscopes and Memory Recorders

**CURRENT PROBE**  
CT6710, CT6711



- Clearly observe signals with high S/N ratio and 10x output rate
- CT6710: DC to 50 MHz
- CT6711: DC to 120 MHz
- 30 Arms max. 3 ranges
- $\phi$  5 mm (0.20 in) Core dia. .... p.80

**CURRENT PROBE**  
CT6700, CT6701



- CT6700: DC to 50 MHz
- CT6701: DC to 120 MHz
- 5 Arms max.
- $\phi$  5 mm (0.20 in) Core dia. .... p.80

**CLAMP ON PROBE**  
3273-50, 3276



- 3276: DC to 100 MHz
- 3273-50: DC to 50 MHz
- 30 Arms max.
- $\phi$  5 mm (0.20 in) Core dia. .... p.81

**CLAMP ON PROBE**  
3274, 3275



- 3275: DC to 2 MHz, 500 Arms max.
- 3274: DC to 10 MHz, 150 Arms max.
- $\phi$  20 mm (0.79 in) Core dia. .... p.81

## Power Supplies for Current Probes

**POWER SUPPLY**  
3269, 3272



- 3269: Power 2  $\times$  CT6710 series or 4  $\times$  CT6700, 3270 series
- 3272: Power 1  $\times$  CT6700, 3270 series ..... p.81

## Current Probes to Observe Waveforms Using Wide-Band Power Analyzers

**AC/DC CURRENT SENSOR**  
CT6904A



- Frequency bandwidth CT6904A
- Amplitude: DC to 4 MHz, 500 A AC/DC
- Phase: DC to 1 MHz
- CT6904A-2
- Amplitude: DC to 4 MHz, 800 A AC/DC
- Phase: DC to 1 MHz
- $\phi$  32 mm (1.26 in) Core dia. .... p.82

**AC/DC CURRENT SENSOR**  
CT6875A, CT6876A, CT6877A



- Frequency bandwidth
- CT6875A: Amplitude: DC to 2 MHz, 500 A AC/DC, Phase: DC to 1 MHz,  $\phi$  36 mm (1.42 in) Core dia.
- CT6876A: Amplitude: DC to 1.5 MHz, 1000 A AC/DC, Phase: DC to 1 MHz,  $\phi$  36 mm (1.42 in) Core dia.
- CT6877A: Amplitude: DC to 1 MHz, 2000 A AC/DC, Phase: DC to 700 kHz,  $\phi$  80 mm (3.15 in) Core dia. .... p.82

**AC/DC CURRENT SENSOR**  
CT6872, CT6873



- Frequency bandwidth
- CT6872: Amplitude: DC to 10 MHz, 50 A AC/DC, Phase: DC to 1 MHz
- CT6873: Amplitude: DC to 10 MHz, 200 A AC/DC, Phase: DC to 1 MHz
- $\phi$  24 mm (0.94 in) Core dia. .... p.83

**AC/DC CURRENT SENSOR**  
CT6862, CT6863



- Frequency bandwidth
- CT6862-05: Amplitude: DC to 1 MHz, 50 A AC/DC rated, Phase: DC to 300 kHz
- CT6863-05: Amplitude: DC to 500 kHz, 200 A AC/DC rated, Phase: DC to 300 kHz
- $\phi$  24 mm (0.94 in) Core dia. .... p.83

**AC/DC CURRENT PROBE**  
CT6844A, CT6845A, CT6846A



- Frequency bandwidth
- CT6844A: DC to 500 kHz, 500 A AC/DC rated
- CT6845A: DC to 200 kHz, 500 A AC/DC rated
- CT6846A: DC to 100 kHz, 1000 A AC/DC rated
- Core dia. CT6844-05:  $\phi$  20 mm (0.79 in), CT6845-05:  $\phi$  50 mm (1.97 in), CT6846-05:  $\phi$  50 mm (1.97 in) ..... p.84

**AC/DC CURRENT PROBE**  
CT6841A, CT6843A



- Frequency bandwidth
- CT6841A: DC to 2 MHz, 20 A AC/DC rated
- CT6843A: DC to 700 kHz, 200 A AC/DC rated
- $\phi$  20 mm (0.79 in) Core dia. .... p.85

**CLAMP ON SENSOR**  
9272-05



- Frequency bandwidth
- Amplitude: 1 Hz to 100kHz
- Phase: 5 Hz to 50 kHz
- 20A or 200A AC rated
- $\phi$  46 mm (1.81 in) Core dia. .... p.85

## Power Supplies for Current Probes

**SENSOR UNIT**  
CT9555, CT9556, CT9557



- Power supply for current sensors
- CT9555: 1ch, with waveform output
- CT9556: 1ch, with waveform / RMS output
- CT9557: 4ch, with waveform / total waveform / total RMS output ..... p.84

## AC/DC Current input

**AC/DC CURRENT BOX**  
PW9100A



- Direct current measurement option for PW8001/PW6001/PW3390
- Wide-band DC to 3.5MHz, 50A AC/DC rated input, 0.04V/A output
- PW9100A-3 : 3 channels
- PW9100A-4 : 4 channels ..... p.71

## AC/DC Current Clamps Terminal HIOKI PL14

**AC/DC AUTO-ZERO CURRENT SENSOR**  
CT7700 series



- DC to 5kHz (-3dB)
- Rated current, core dia.
- CT7742: 2000A AC/DC,  $\phi$  55 mm (2.17 in) core dia.
- CT7736: 600A AC/DC,  $\phi$  33 mm (1.30 in) core dia.
- CT7731: 100A AC/DC,  $\phi$  33 mm (1.30 in) core dia. .... p.86

**AC/DC CURRENT SENSOR**  
CT7600 series



- DC to 10kHz (-3dB)
- Rated current, core dia.
- CT7642: 2000A, AC/DC  $\phi$  55 mm (2.17 in)
- CT7636: 600A AC/DC,  $\phi$  33 mm (1.30 in) core dia.
- CT7631: 100A AC/DC,  $\phi$  33 mm (1.30 in) core dia. .... p.86

**DISPLAY UNIT**  
CM7290, CM7291



- Use with CT7000 series current sensors
- DCA, ACA, (DC+AC)A, frequency measurement
- Power supply for single sensor
- Built in Bluetooth® wireless technology [CM7291] ..... p.87

## AC Current Clamps Terminal HIOKI PL14

**AC CURRENT SENSOR**  
CT7126, CT7131, CT7136



- CT7126
- Frequency band up to 20 kHz
- 60 A AC rated input
- $\phi$  15 mm (0.59 in) Core dia.
- CT7131
- 100 A AC rated input
- $\phi$  15 mm (0.59 in) Core dia.
- CT7136
- 600 A AC rated input
- $\phi$  46 mm (1.81 in) Core dia. .... p.89

**AC FLEXIBLE CURRENT SENSOR**  
CT7040 series



- 10 Hz to 50 kHz ( $\pm$ 3dB)
- 6000A AC rated
- loop diameters
- CT7044:  $\phi$  100 mm (3.94 in)
- CT7045:  $\phi$  180 mm (7.09 in)
- CT7046:  $\phi$  254 mm (10.0 in) ..... p.87

## AC Current Clamps Terminal BNC

**CLAMP ON SENSOR**  
9695



- 9695-02 Requires the 9219
- 40 Hz to 5 kHz
- Phase: 45 Hz to 5 kHz
- 50 A AC rated input
- $\phi$  15 mm (0.59 in) Core dia.
- 9695-03 Requires the 9219
- 100 A AC rated input ..... p.89

**CLAMP ON SENSOR**  
9661, 9669



- 9661
- 500 A AC rated input
- $\phi$  46 mm (1.81 in) Core dia.
- 9669
- 40 Hz to 5 kHz
- Phase: 45 Hz to 5 kHz
- 1000 A AC rated input
- $\phi$  55 mm (2.17 in) Core dia. .... p.89

**AC FLEXIBLE CURRENT SENSOR**  
CT9667



- 10 Hz to 20 kHz ( $\pm$ 3dB)
- 5000 A / 500 A AC rated input
- Three types of core dia. :  $\phi$  100 mm (3.94 in) to  $\phi$  254 mm (10.0 in) ..... p.88

## AC Current Clamps Terminal BNC

**CLAMP ON SENSOR**  
9660, 9694



- 9660:
- Frequency characteristics
- Amplitude: 40Hz to 5kHz, Phase: 45Hz to 5kHz
- 100 A AC rated input
- $\phi$  15 mm (0.59 in) Core dia.
- 9694:
- 5 A AC rated input ..... p.89

## Leak Current Terminal HIOKI PL14

**AC LEAKAGE CURRENT SENSOR**  
CT7116



- Frequency band 40 Hz to 5 kHz
- 6 A AC rated input
- $\phi$  40 mm (1.57 in) Core dia. .... p.89

## Leak Current Terminal BNC

**CLAMP ON LEAK SENSOR**  
9657-10, 9675



- 9657-10
- 9657-10:  $\phi$  40 mm (1.57 in) Core dia.
- 9675:
- Frequency characteristics
- Amplitude: 40Hz to 5kHz
- Primary rated 10 A AC
- $\phi$  30 mm (1.18 in) Core dia. .... p.89

## Load Current Terminal BNC

**CLAMP ON PROBE**  
9132-50, 9010-50, 9018-50



- Use for level measurement
- 9132-50: AC 20 to 1000 A,  $\phi$  55 mm (2.17 in) Core dia.
- 9010-50: AC 10 to 500 A,  $\phi$  46 mm (1.81 in) Core dia.
- Excellent phase characteristics
- 9018-50: AC 10 to 500 A,  $\phi$  46 mm (1.81 in) Core dia. .... p.88

## RGB LASER / LED and Optical Power Meters for Production Lines

RGB LASER METER  
TM6102



- Irradiance, centroid wavelength
- Illuminance, chromaticity
- Specially designed for laser photometry

RGB LASER LUMINANCE  
METER TM6103



- Radiance, centroid wavelength
- Luminance, chromaticity
- Specially designed for laser photometry

OPTICAL POWER METER  
TM6104



- Radiant flux (optical power), centroid wavelength
- Luminous flux, chromaticity
- Specially designed for laser photometry

LED OPTICAL METER  
TM6101



- Measure the optical characteristics of white LEDs and LED lighting during production.
- Measure luminous intensity, chromaticity, and color rendering index

OPTICAL POWER METER  
3664



- Measure the LD light of optical disks
- 4-1/2 digit, 0.01 dBm resolution
- Remote control and data acquisition via USB

## Communication Testing for Electrical Construction

LAN CABLE HITESTER  
3665



- Use for installing LAN cables or repair maintenance
- Detect split pairs with wiring check
- Get NVP-Enhanced measurement
- Identify cable destinations

## PV Maintenance Testers

BYPASS DIODE TESTER  
FT4310



- Test for open or short-circuit bypass diodes even during the day
- Easily test using the strings in the junction boxes
- Automatically transfer data wirelessly via Bluetooth® wireless technology

INSULATION TESTER  
IR4053



- Built-in dedicated PV function
- 600 V AC/ 1000 V DC
- 5 test voltage ranges from 50 to 1000 V
- Comparator function
- Integrated hard carrying case

## Magnetic Field Testing

MAGNETIC FIELD HITESTER  
FT3470-52



- To measure as defined by IEC/EN 62233
- Compliance testing of household appliances
- Compliant to ICNIRP 2010 guidelines
- 10 Hz to 400 kHz
- Bundled with 100 cm<sup>2</sup> and 3 cm<sup>2</sup> sensors

MAGNETIC FIELD HITESTER  
FT3470-51



- To measure as defined by IEC/EN 62233
- Compliance testing of household appliances
- Compliant to ICNIRP 2010 guidelines
- 10 Hz to 400 kHz
- Bundled with 100 cm<sup>2</sup> sensor

## Infrared Thermometers

INFRARED THERMOMETER  
FT3701



- Long-focus, precise-field type
- φ 100mm at a 3m distance
- -35.0 °C to 500.0 °C
- Measurement wavelength 8 to 14μm
- Two-beam laser marker

INFRARED THERMOMETER  
FT3700



- Long-focus type
- φ 83mm at a 1m distance
- -35.0 °C to 500.0 °C
- Measurement wavelength 8 to 14μm
- Two-beam laser marker

## Temperature Measurement

WIRELESS HUMIDITY LOGGER  
LR8514, etc.



Refer to the Wireless Logger series for temperature measurement

WIRELESS LOGGING  
STATION LR8410



Refer to the Multi-channels Wireless Logger series for temperature measurement

Compact Data Logger  
LR5000 Series



Refer to the LR5000 Data Logger series for temperature measurement

Temperature probes



- K type thermocouple
- Pt 100

## Heat Flow Testing

HEAT FLOW LOGGER  
LR8432



Heat flow/DC/Temperature/Pulse measurement

## Forecast Likelihood of Fungal Growth

WIRELESS FUNGAL LOGGER  
LR8520



- Record fungal index, growth prediction, temperature and humidity
- Minimum 0.5 sec interval
- Wireless data download to a tablet or computer
- 500,000 data/ ch
- Alarm output
- Three-way power

## Illumination / Sound Level Testing

SOUND LEVEL METER  
FT3432



- IEC 61672-1 Class2 compliant
- 30dB to 137 dB
- DC output / AC monitor output

LUX METER  
FT3424, FT3425



- DIN 5032-7:1985 class B, JIS C 1609-1: 2006 general AA class compliant
- 0 to 200 000 lx
- Timer hold function
- Memory function
- Built-in Bluetooth® wireless technology (FT3425)



# Digital Multimeter/Tester Index

Because the DMM offers a large number of measurement functions and ranges, only a representative value (maximum accuracy) for each range is included as the basic accuracy (due to space limitations). For more accuracy information for each range, please see the detailed catalog or user manual.

## High-Precision Handheld DMM

DIGITAL MULTIMETER  
DT4282



- 60000 count display
- DC+AC Voltage measurement
- + Peak, - Peak measurement
- Low-pass filter function
- 10 A Direct input
- USB communication (option)
- True RMS
- CAT IV 600 V

p.97

DIGITAL MULTIMETER  
DT4281



- 60000 count display
- DC+AC Voltage measurement
- + Peak, - Peak measurement
- Low-pass filter function
- AC Current measurement with Clamp-on probe
- USB communication (option)
- True RMS
- CAT IV 600 V

p.97

## DMM for on-site maintenance

DIGITAL MULTIMETER  
DT4261



- 6000 count display
- DC+AC Voltage measurement
- + Peak, - Peak measurement
- Low-pass filter function
- USB communication (option)
- True RMS
- CAT IV 600 V
- Compatible with Wireless Adapter Z3210

p.98

## DMM for Electrical Work

DIGITAL MULTIMETER  
DT4255



- 6000 count display
- Current-limiting resistor/ fast-blow fuse
- Low-pass filter function
- AC current measurement with clamp-on probe
- Voltage detector
- USB communication (option)
- True RMS
- CAT IV 600 V

p.99

DIGITAL MULTIMETER  
DT4223



- 6000 count display
- Protective function against accidental voltage input
- Low-pass filter function
- No current measurement
- Voltage detector
- True RMS
- CAT III 600 V

p.100

DIGITAL MULTIMETER  
DT4221



- 6000 count display
- Low-pass filter function
- No current or resistance measurements
- Voltage detector
- True RMS
- CAT III 600 V

p.100

## DMM for Heating, Ventilation and Air Conditioning (HVAC)

DIGITAL MULTIMETER  
DT4253



- 6000 count display
- Low-pass filter function
- DC 60µA to 60mA measurement
- AC Current measurement with Clamp-on probe
- USB communication (option)
- True RMS
- CAT IV 600 V

p.99

## General Purpose DMM

DIGITAL MULTIMETER  
DT4256



- 6000 count display
- Low-pass filter function
- 10 A Direct input
- AC current measurement with clamp-on probe
- Voltage detector
- USB communication (option)
- True RMS
- CAT IV 600 V

p.99

DIGITAL MULTIMETER  
DT4252



- 6000 count display
- Low-pass filter function
- 10 A Direct input
- USB communication (option)
- True RMS
- CAT IV 600 V

p.99

DIGITAL MULTIMETER  
DT4224



- 6000 count display
- Protective function against accidental voltage input
- Low-pass filter function
- No current measurement
- True RMS
- CAT III 600 V

p.100

DIGITAL MULTIMETER  
DT4222



- 6000 count display
- Low-pass filter function
- No current measurements
- Capacitance and diode testing
- True RMS
- CAT III 600 V

p.100

PENCIL HITESTER  
3246-60



- New insulated test pin sleeves prevent short-circuits
- Pencil type DMM
- CAT III 600 V
- 4199 count display
- Average rectified
- Ultra bright LED light at probe tip

p.101

CARD HITESTER  
3244-60



- New insulated test pin sleeves prevent short-circuits
- A thin card size DMM
- CAT III 300 V, CAT II 600 V
- 4199 count display
- Average rectified

p.101

## Analog Multimeters

HiTESTER  
3030-10



- Basic type analog tester
- CAT III 600V
- Average rectified

p.101

## Benchtop Multimeters for Production and Inspection Lines

PRECISION DC VOLTMEETER  
DM7275, DM7276



- DC V only
- Measure DC voltage and temperature simultaneously
- 7-1/2 digit resolution
- 1-year 20ppm Accuracy (DM7275)
- 1-year 9ppm Accuracy (DM7276)
- Built-in EXT I/O, LAN, and USB

p.61

## System Integrated Digital Multi-Module Stations

DMM STATION  
U8991+MR8740T



- Store entire data from 108 units of DMM in single operation
- Simultaneous 108 ch sampling without signal scanner
- High  $\pm 0.02\%$  precision & ultra high 6-1/2 digit resolution
- 500 times/s sampling

p.61

DMM STATION  
MR8990+MR8741



- Store entire data from 16 units of DMM in single operation
- Simultaneous 16 ch sampling without signal scanner
- High  $\pm 0.01\%$  precision & ultra high 6-1/2 digit resolution
- 500 times/s sampling

p.61

DMM STATION  
MR8990+MR8740



- Store entire data from 54 units of DMM in single operation
- Simultaneous 16 ch sampling without signal scanner
- High  $\pm 0.01\%$  precision & ultra high 6-1/2 digit resolution
- 500 times/s sampling

p.61

## 5-Range Digital Meg-ohm Meters

INSULATION TESTER IR4053



- Built-in dedicated PV function
- 600 V AC/ 1000 V DC
- 5 test voltage ranges from 50 to 1000 V
- Comparator function
- Integrated hard carrying case

HIGH VOLTAGE INSULATION TESTER IR3455



- 5 high voltage ranges
- 250/500/1k/2.5k/5k V testing voltages
- Leak current, voltage, temperature, insulation resistance testing, data memory
- Integrated hard carrying case

## 5-Range Digital Meg-ohm Meters for Electrical Equipment Maintenance

INSULATION TESTER IR4057-50



- 5 test voltage ranges from 50 to 1000 V
- High-speed measurement with bar graph
- Comparator detection function
- 600 V AC/DC voltmeter
- Compatible with Wireless Adapter Z3210

INSULATION TESTER IR4056



- 5 test voltage ranges from 50 to 1000 V
- Comparator function
- 600 V AC/DC meter
- 200 mA continuity check
- Integrated hard carrying case

## 3-Range Analog Meg-ohm Meters

ANALOG MΩ HITESTER 3490



- 3 ranges
- 250/500/1000 V testing voltages
- 200 mA continuity (3 Ω resistance range)
- AC voltage measurement
- Bright LED, luminous scale
- Integrated hard carrying case

## Single-Range Analog Meg-ohm Meters

ANALOG MΩ HITESTER IR4018



- Single range
- 1000 V testing voltage (2000 MΩ)
- AC voltage measurement
- Bright LED, luminous scale
- Integrated hard carrying case

ANALOG MΩ HITESTER IR4017



- Single range
- 500V testing voltage (1000 MΩ)
- AC voltage measurement
- Bright LED, luminous scale
- Integrated hard carrying case

ANALOG MΩ HITESTER IR4016



- Single range
- 500 V testing voltage (100 MΩ)
- AC voltage measurement
- Bright LED, luminous scale
- Integrated hard carrying case

## Ground Clamps and Earth Resistance Testers

CLAMP ON EARTH TESTER FT6380-50



- Grounding resistance measurement for multiple-ground installations
- Current measurement capable (AC)
- CAT IV 600 V compliant
- RMS measurement (true RMS rectification)
- Compatible with Wireless Adapter Z3210

EARTH TESTER FT6031-50



- 3- or 2- pole method
- Supports Class A to Class D ground types
- IP67 dustproof and waterproof
- Compatible with Wireless Adapter Z3210

ANALOG EARTH TESTER FT3151



- Three or two electrode measurement method
- EN and JIS standard

## Voltage Detectors

VOLTAGE DETECTOR 3481



- Non-metallic contact
- 40 to 600 V AC range
- Sensitivity adjustment function
- With LED light

## Phase Detectors

DIGITAL PHASE DETECTOR PD3259-50



- Non-metallic voltage measurements
- Non-metallic measure voltage and detect phase sequence simultaneously
- 90 to 520 V AC
- φ 6 - 30 mm (0.24 - 1.18 in) core dia.
- Compatible with Wireless Adapter Z3210

PHASE DETECTOR PD3129



- Non-metallic contact clip PD3129-10: For use on 70 to 1000 V lines (50/60 Hz), Thick conductors φ 10 - 40 mm (0.39 - 1.57 in) core dia.
- PD3129: For use on 70 to 600 V lines (50/60 Hz), Conductors φ 2.4 - 17 mm (0.09 - 0.67 in) core dia.

## AC Current Leakage Clamp Meters

CLAMP ON EARTH TESTER  
FT6380-50



- Grounding resistance measurement for multiple-ground installations
  - Current measurement capable (AC)
  - CAT IV 600 V compliant
  - True RMS
  - Compatible with Wireless Adapter Z3210
- ..... p.112

AC LEAKAGE CLAMP METER  
CM4001



- Measure everything from leakage to load
  - 0.60 mA (resolution 10  $\mu$ A) to 600.0 A
  - True RMS
  - Filter function
  - Inrush current measurement
  - Compatible with Wireless Adapter Z3210
- ..... p.111

AC LEAKAGE CLAMP METER  
CM4002, CM4003



- Measure everything from leakage to load
  - 0.060 mA (resolution: 1  $\mu$ A) to 200.0 A
  - True RMS
  - External output function (CM4003)
  - Compatible with Wireless Adapter Z3210
- ..... p.111

## AC Current Clamp Meters for Electrical Work

AC CLAMP METER  
CM4141-50



- Thin jaw easily gets into tight spaces
  - 60 to 2000 AAC range
  - True RMS
  - V, A, Hz,  $\Omega$ , and other extensive measurement parameters
  - Compatible with Wireless Adapter Z3210
- ..... p.109

AC CLAMP METER  
CM3281  
CM3291



- 42 to 2000 AAC range
  - Average rectified (CM3281)
  - True RMS (CM3291)
  - V, A,  $\Omega$ , and other extensive measurement parameters
- ..... p.110

AC CLAMP METER  
CM3289



- 42 to 1000 AAC range
  - Weighing only 100g with thin 16 mm body
  - True RMS
  - DMM function
- ..... p.109

AC CLAMP METER  
3280-10F



- 42 to 1000 AAC range
  - Weighing only 100g with thin 16 mm body
  - Average rectified
  - DMM function
- ..... p.109

## AC/DC Current Clamp Meters for General Industrial Applications

AC/DC CLAMP METER  
CM4375-50



- Easily get into tight spaces
  - 1000 A AC/DC range
  - True RMS
  - V, A, Hz,  $\Omega$ , and other extensive measurement parameters
  - Inrush current
  - Compatible with Wireless Adapter Z3210
- ..... p.106

AC/DC CLAMP METER  
CM4373-50



- 600/2000 A AC/DC range
  - True RMS
  - V, A, Hz,  $\Omega$ , and other extensive measurement parameters
  - Inrush current
  - Max/Min/Avg/Peak
  - Compatible with Wireless Adapter Z3210
- ..... p.106

AC/DC CLAMP METER  
CM4371-50



- 20/600 A AC/DC range
  - True RMS
  - V, A, Hz,  $\Omega$ , and other extensive measurement parameters
  - Inrush current
  - Max/Min/Avg/Peak
  - Compatible with Wireless Adapter Z3210
- ..... p.107

CLAMP ON AC/DC HITESTER  
3288



- 100/ 1000 A AC/DC range
  - True RMS (3288-20)
  - Average rectified (3288)
  - Weighing only 150g with thin 16 mm body
  - DMM function
- ..... p.107

CLAMP ON AC/DC HITESTER  
3287



- 10/ 100 A AC/DC range
  - True RMS
  - Weighing only 170g with thin 16 mm body
  - DMM function
- ..... p.108

DISPLAY UNIT  
CM7290, CM7291



- Use with CT7000 series current sensors
  - DCA, ACA, (DC+AC)A, frequency measurement
  - Power supply for single sensor
  - Built-in Bluetooth® wireless technology (CM7291)
- ..... p.87

## Handheld Power Meter

AC CLAMP POWER METER  
CM3286-50



- Easy AC power checker
  - Single-phase, 3-phase (balanced condition/without distortion)
  - Phase angle, power factor
  - Voltage/current harmonics (with Z3210 installed)
  - AC clamp, True RMS, Battery operation
  - Compatible with Wireless Adapter Z3210
- ..... p.79

## Accessories for AC Clamp Meters

AC FLEXIBLE CURRENT  
SENSOR CT6280



- For large diameter and large current measurement in combination with AC clamp meter
  - 4200 A AC continuous
- ..... p.110

CLAMP ON ADAPTER  
9290-10



- Primary 1000A, secondary 100A (1/10 ratio) output
  - Superior phase angle characteristics for power
- ..... p.89

## Custom Meter Relays for Systems Integration

### METER RELAY 2104H/L/HL



- 1 channel analog scale
- Electronic design assures high accuracy and reliability
- ±1.5% class
- 100 mm (3.94 in) width

### METER RELAY 2103H/L/HL



- 1 channel analog scale
- Electronic design assures high accuracy and reliability
- ±2.5% class
- 80 mm (3.15 in) width

## Current Transformers

### CURRENT TRANSFORMER CT-5MRN series



- For 50/60 Hz lines only
- 5 VA rated load
- Polyester resin mold type

## Shunts and Multipliers

### EXTERNAL SHUNTS HS-1 series



- Use in combination with a 50 mV meter
- 30A to 300A

# New Solutions Index

## Connecting Instruments in the Field with IT

### GENNECT Cross SF4071, SF4072



- Mobile app for iOS and Android
- Improve efficiency especially for repeated measurements and recording
- Find root cause of failures through data analysis and create quick reports

### WIRELESS ADAPTER Z3210



- Simply plug in the Z3210 wireless adapter and your compatible HIOKI device is Bluetooth® ready

### GENNECT One SF4000



- Automatically pair with LAN-connected measuring instruments
- Display acquired data graphically in real-time
- List MAX, MIN and AVG values
- Windows compatible

### GENNECT Cloud SF4180



- Connects to the GENNECT series to provides added value through cloud services
- Exchanging data via the cloud
- Offers a range of plans and payment methods

## WPT TEST SYSTEM

### WPT TEST SYSTEM TS2400



- Generates four types of characteristics graphs in real time, even while testing is still in progress
- Automatic measurement, automatic data collection
- Position transmission coils with a radius of up to 800 mm

## Highest Measurement Capabilities and Fastest Transfer Rate in History

### MEMORY HiCORDER MR6000



Germany iF Design Award

- Work efficiently and intuitively using the MR6000's large touch panel
- Capture momentary phenomena by performing isolation measurement at up to 200 MS/s (when using the High Speed Analog Unit U8976)
- Enjoy a stress-free user experience thanks to dramatically faster saving of data
- Save data in real time while measurement continues
- CAN, CAN FD, and LIN measurement; MDF saving
- Generate user-defined waveforms and monitor values

Model No. (Order Code) **MR6000** (Main unit only, input modules up to 8 units)  
**MR6000-01** (Built-in real-time waveform calculation and other functionality)

Note: Main unit MR6000/MR6000-01 cannot operate alone. You must install one or more optional input modules in the unit.

Note: user cannot install or change the SSD Unit U8332, the HD Unit U8333, and the Z5021

**Options A**

**PROBE POWER UNIT Z5021**  
Specified upon order of the MR6000, power max. 4 × C16710 series, or max. 8 × other probes

**CARRYING CASE C1010**  
For the MR6000, includes compartment for options, hard trunk type

**SSD UNIT U8332**  
Specified upon order, built-in type, 256 GB

**HD UNIT U8333**  
Specified upon order, built-in type, 320 GB

**Storage Media Precaution**  
Use only Storage Media sold by HIOKI. Compatibility and performance are not guaranteed for Storage Media made by other manufacturers. You may be unable to read from or save data to such media.

**SD MEMORY CARD 2GB Z4001**  
2 GB capacity

**SD MEMORY CARD Z4003**  
8 GB capacity

**USB DRIVE Z4006**  
16 GB, Long-life, High-reliability SLC Flash Memory

#### Basic specifications (Accuracy guaranteed for 1 year)

	MR6000	MR6000-01
Additional function	N/A	Real-time waveform calculation, Digital Filter calculation
Number of input units	Max. 8 units	
Number of channels	Max. 32 analog channels (when using the U8975), or 128 logic channels (when using the U8976)	
Measurement ranges (20 div full-scale)	10 mV to 400 V f.s., 12 ranges (when using the U8976), Resolution: 1/1600 of range 4 V to 200 V f.s., 6 ranges (when using the U8975), Resolution: 1/32000 of range	
Max. allowable input	400 V DC (when using the U8976), 200 V DC (when using the U8975)	
Frequency characteristics	DC to 30 MHz (when using the U8976), DC to 2 MHz (when using the U8975)	
Max. sampling rate	200 MS/s, all channels simultaneously (when using the U8976) External sampling: 10 MS/s	
Recording methods	Normal: Normal waveform recording Envelope: Record maximum and minimum values every fixed period Dual sampling: Record waveforms at a sampling rate that differs from the envelope during envelope measurement	
Calculation functions	Numerical calculation, waveform processing*, FFT calculations *Power fluctuation analysis using full-wave average operator	
Storage memory capacity	1 G-words	
Removable storage	SD memory card ×1, USB memory ×7, SSD/HDD (built in the main unit) ×1 FTP transmission (to LAN-connected computer) *Use only Storage Media sold by HIOKI.	
Display	12.1 inch XGA-TFT color LCD (1024 × 768 dots)	
Display formats	Time-domain waveform representation, XY composite waveform display, FFT display	
External interfaces	LAN, USB, SD, SATA, Monitor output	
Power supply	100 to 240 V AC (50/60 Hz) (300 VA max.)	
Dimensions and mass	353 mm (13.9 in)W × 235 mm (9.25 in)H × 154.8 mm (6.09 in)D, 6.5 kg (229.3 oz) (main unit only)	
Included accessories	Power cord ×1, Quick start manual ×1, Precautions concerning use ×1, Application disk (CD-R) ×1, Instruction manual (CD-R, detail and calculation) ×1, Blank panel (for blank slots only)	

Other options refer to the detailed catalog

Install by inserting into the main unit. Can be replaced by user.

Options B	Options C	Options D
<ul style="list-style-type: none"> <li>• <b>ANALOG UNIT 8966</b> 2 ch, voltage input, 20MS/s (DC to 5 MHz)</li> <li>• <b>TEMP UNIT 8967</b> 2 ch, thermocouple temperature input</li> <li>• <b>HIGH RESOLUTION UNIT 8968</b> 2 ch, voltage input, 1MS/s (DC to 100 kHz)</li> <li>• <b>STRAIN UNIT U8969</b> 2 ch, strain gauge type converter amp</li> <li>• <b>FREQ UNIT 8970</b> 2 ch, for measurement of frequency, rpm, pulse</li> <li>• <b>CURRENT UNIT 8971</b> 2 ch, for measuring current using dedicated current sensors</li> </ul>	<ul style="list-style-type: none"> <li>• <b>DC/RMS UNIT 8972</b> 2 ch, Voltage, 1MS/s (DC to 400 kHz), or RMS (DC/ 30 to 100 kHz)</li> <li>• <b>LOGIC UNIT 8973</b> 4 terminals, 16 ch</li> <li>• <b>DIGITAL VOLTMETER UNIT MR8990</b> 2 ch, DC V input, 0.1 μV resolution, 500 times/s sampling</li> <li>• <b>HIGH VOLTAGE UNIT U8974</b> 2 ch, voltage input, max. 1000 V DC, 700 V AC</li> <li>• <b>4CH ANALOG UNIT U8975</b> 4 ch, voltage input, SMS/s (DC to 2 MHz)</li> </ul>	<ul style="list-style-type: none"> <li>• <b>HIGH SPEED ANALOG UNIT U8976</b> 2 ch, Voltage input, 200MS/s (DC to 30 MHz)</li> <li>• <b>3CH CURRENT UNIT U8977</b> 3 ch, current measurement by dedicated current sensor</li> <li>• <b>4CH ANALOG UNIT U8978</b> 4 ch, voltage input, SMS/s (DC to 2 MHz)</li> <li>• <b>CHARGE UNIT U8979</b> 2 ch, for acceleration measurement, charge output / preamplifier output / voltage output</li> <li>• <b>ARBITRARY WAVEFORM GENERATOR UNIT U8793</b> 2 ch, FG function 10 mHz to 100 kHz, Arbitrary waveform generator DA refresh rate 2 MHz, Output 15 V</li> </ul>

## Capture High- to Low-Voltage Signals in a Single Device! Rugged, Professional and Ready for the Field

### MEMORY HiCORDER MR8880

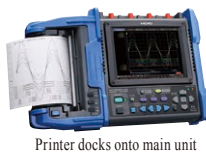

Printer docks onto main unit

Printer unit is optional

- CAT III 600V isolation performance; directly measure a 480V power line
- 4 completely isolated channels let you simultaneously record data on a 3-phase power line plus have one extra channel
- Tough against harsh environments: -10°C to 50°C operating temperature range
- Built to withstand mechanical shocks and vibrations (ships standard with side protectors)
- Make settings easily with PRESETS function

Model No. (Order Code) **MR8880-20** (4ch, printer unit option, English model)

Note: Input cords and Battery Pack are not included. Purchase the cords appropriate for your application separately. Printer Unit MR9000 is optional and sold separately.

#### Basic specifications (Accuracy guaranteed for 1 year)

Number of channels	4 analog channels + 8 logic channels (standard) Note: Isolated analog channels, isolated input and frame, logic has common GND
Measurement ranges (10 div full-scale)	4 channels of voltage measurement; mode switchable between instantaneous waveform or RMS value, 10 mV to 100 V/div, 13 ranges, resolution: 1/640 of range RMS value mode: 30 Hz to 10 kHz, Crest factor: 2
Max. rated voltage	Between terminals: 600 V AC/DC, Between terminal to earth: 600 V AC/DC CAT III; 300 V AC/DC CAT IV
Frequency characteristics	DC to 100 kHz (±3dB)
Time axis (High-speed function)	100 μs to 100 ms/div, 10 ranges, Sampling period: 1/100 of range
Recording intervals (Real-time function)	100 μs to 1 minute, 19 selections (simultaneous sampling in all channels)
Measurement functions	High-speed function (high speed recording) Real-time function (actual time recording)
Memory capacity	14-bits × 1M-words/ch (1 word = 2 bytes)
Removable storage	CF card slot ×1 (Up to 2 GB), USB 2.0 memory ×1
Printing	[Printer unit is option] 112 mm (4.41 in) × 18 mm (59.06 ft), thermal paper roll, Recording speed: 10 mm (0.39 in)/sec Note: Printing is not supported when using alkaline batteries
Display	5.7-inch VGA-TFT color LCD (640 × 480 dots)
Displayable languages	English, Japanese, Chinese
Communication interfaces	USB 2.0 mini-B receptacle × 1; Transfers files from the installed CF card or USB memory stick to a PC when connected, and External PC control
Power supply	AC adapter Z1002: 100 to 240 V AC (50/60 Hz), 45 VA (include AC adapter, when Real-time recording), 107 VA (include AC adapter, when Real-time recording and printing) Battery pack Z1000: AC adapter has priority when used in combination with battery pack, recharge with AC adapter 3 hours, Continuous use 3 hours (with back-light ON) LR6 (AA) alkaline batteries ×8, Continuous use 40 minutes, (with back-light ON, cannot be used with the Printer unit) DC power supply: 10 to 28 V DC (cable available by special order)
Dimensions and mass	205 mm (8.07 in)W × 199 mm (7.83 in)H × 67 mm (2.64 in)D, 1.66 kg (58.6 oz) (with the Battery pack installed) When printer is combined - with main unit: 303 mm (11.93 in)W × 199 mm (7.83 in)H × 67 mm (2.64 in)D, 2.16 kg (76.2 oz) (with the Battery pack installed)
Included accessories	Instruction manual ×1, AC adapter Z1002 ×1, Alkaline battery box ×1, Strap ×1, USB cable ×1, Application disk (Wave viewer Wv, Communication commands table) ×1

AC adapter Z1002 is bundled with the MR8880

**PRINTER UNIT MR9000**  
Printing width 100 mm (3.94 in), used together with the MR8880-20 main body, includes 1 roll of recording paper

**AC ADAPTER Z1002**  
For main unit, 100 to 240 V AC

**BATTERY PACK Z1000**  
NiMH, Charges while installed in the main unit

**CARRYING CASE C1003**  
For the MR8880, includes compartment for options, soft case type

**Options**

PC CARD 2G 9830 (2 GB capacity)  
PC CARD 1G 9729 (1 GB capacity)

Other options: refer to the detailed catalog

**RECORDING PAPER 9234**  
112 mm (4.41 in) × 18 mm (59.06 ft), roll type, 10 rolls/set

PC CARD 512M 9728 (512 MB capacity)

## 1000V Direct Input Multi-channel Logger

### MEMORY HiCORDER MR8875



#### Basic specifications (Accuracy guaranteed for 1 year)

Number of input units	Up to 4 slots
Number of channels	Max. 16 analog channels (Max. 60 channels when using the MR8902) + standard 8 logic channels + 2 pulse channels <i>Note: For analog units, channels are isolated from each other and from the MR8875's GND. For CAN unit ports or standard logic terminals or standard pulse terminals, all channels have common GND.</i>
Measurement ranges (20 div full-scale)	5 mV to 10 V/div, 11 ranges (when using the MR8901), 500 mV to 50 V/div, 7 ranges (when using the MR8905), resolution: 1/1250 of range
Max. rated voltage	Between terminals: 1000 V DC, 700 V AC (when using the MR8905)
Frequency characteristics	DC to 100 kHz (-3 dB, when using the MR8901)
Time axis	200 μs to 5 min/div, 21 ranges, sampling period: 1/100 of range, External sampling possible
Max. sampling rate	[When using MR8901] 500 kS/s (2 μs period, all channels simultaneously) [When using MR8902] 120 ms (all input channels are scanned at high speed during every recording interval) [When using MR8903] 200 kS/s (5 μs period, all channels simultaneously) External sampling: 200 kS/s (5 μs period)
Measurement functions	High-speed function (high speed recording), Real-time calculation between channels, FFT calculation, or other functions
Storage memory capacity	Total 32 M-words (memory expansion: N/A, 8 MW each input unit) <i>Note: 1 word = 2 bytes, therefore 32 Mega-words = 64 Mega-bytes.</i> <i>Note: Storage memory can be allocated depending on the number of channels used at each input unit</i>
Removable storage	SD card slot ×1, USB 2.0 memory
Display	Touch-panel operation 8.4-inch SVGA-TFT color LCD (800 × 600 dots)
Communication interfaces	LAN: 100BASE-TX (DHCP, DNS supported, FTP server/client, WEB server, send E-mail, command control) USB: USB 2.0 compliant, series mini-B receptacle ×1 (setting / measure with communication command, or file transfer SD card to PC), series A receptacle ×2 (USB memory, USB mouse/ key-board)
Power supply	1) AC adapter Z1002: 100 to 240 V AC (50/60 Hz), 56 VA 2) Battery pack Z1003: 7.2 V DC, 36 VA, continuous operation time: 1 hour with back light ON (AC adapter has priority when used in combination with battery pack), Charges while installed in the MR8875, recharging time: 3 hours 3) External DC Power: 10 to 28 V DC, 56 VA, (please contact your HIOKI distributor for connection cord)
Dimensions and mass	298 mm (11.73 in)W × 224 mm (8.82 in)H × 84 mm (3.31 in)D, 2.4 kg (84.7 oz), (excluding input units and the Battery pack Z1003) Reference data: 3.47 kg/122.4 oz (including the MR8901 ×4 units and the Battery pack Z1003)
Included accessories	Instruction manual ×1, Measurement guide ×1, AC adapter Z1002 ×1, Protection sheet ×1, USB cable ×1, Shoulder strap ×1, Application disk (Wave viewer Wv, communication commands table, CAN Editor) ×1

- 1000V input and instantaneous DC or RMS waveform measurement with new Analog Unit MR8905
- Multi-channel logger capable of thermocouple temperature measurement up to 60 ch at 10 msec intervals
- Measure multiple channels simultaneously despite handheld portable design
- Max. 2 μsec high-speed simultaneous logging for all input channels
- Save directly to the SD Card in real time for uninterrupted long-term logging
- 16-bit high-resolution measurement of voltage, temperature, distortion and CAN signals
- FFT calculation, waveform calculation functions for advanced analysis
- Intuitive touch screen for optimal operability
- Tough against vibrations and extreme temperatures, with strengthened body ideal for in-vehicle testing and road tests
- 3 different power supplies

Model No. (Order Code) **MR8875** (Max. 16 - 60ch, 32MW memory, main unit only)

*Note: Test leads are not included. Purchase the leads appropriate for your application separately. AC Adapter Z1005 is included as standard.*

Other options: refer to the detailed catalog

**AC ADAPTER Z1002**  
For main unit, 100 to 240 V AC

**BATTERY PACK Z1003**  
NiMH, Charges while installed in the main unit

**CAN CABLE 9713-01**  
For the MR8904, unprocessed on one end, 1.8 m (5.91 ft) length

**SD MEMORY CARD 2GB Z4001**  
**SD MEMORY CARD 8GB Z4003**

**CARRYING CASE C1004**  
For the MR8875, includes compartment for options, hard trunk type

Install by inserting into the main unit. Can be replaced by user.

- Input modules**
- ANALOG UNIT MR8901  
4ch, Voltage measurement, DC to 100kHz
  - VOLTAGE/TEMP UNIT MR8902  
15ch, Voltage measurement, Thermocouple measurement
  - STRAIN UNIT MR8903  
4ch, Voltage measurement, Strain gauge converter input
  - CAN UNIT MR8904  
2-port, up to 15 analog channels and up to 16 logic channels
  - ANALOG UNIT MR8905  
2ch, High-voltage measurement (available with MR8875 Ver 2.14/3.14 or later)

## Oscilloscope-like Waveform Observation, Plus Recording of RMS Variations - In a Single Device!

### MEMORY HiCORDER MR8870



#### Basic specifications (Accuracy guaranteed for 1 year)

Number of channels	2 analog channels + 4 logic channels (standard) <i>Note: Isolated analog channels, isolated input and frame, logic has common GND</i>
Measurement ranges	10 mV to 50 V/div (10 div full-scale), 12 ranges, Resolution: 1/100 of range
Max. rated voltage	Between terminals: 400 VDC, Between terminal to earth: 300 VAC, DC CAT II
Frequency characteristics	DC to 50 kHz (-3 dB)
Time axis (Memory mode)	100 μs to 5 min/div, 20 ranges, at 100 points/div resolution, three steps of time-axis magnification from ×2 to ×10, and 9 steps of time-axis compression from ×1/2 to ×1/1,000
Recording intervals (RMS mode)	1 ms to 1 min., 16 settings, sampling period: 200 μs (fixed) (for AC voltage/current, 1,000 RMS values/sec.), envelope mode always on <i>Note: Only the maximum value and minimum value for each recording interval are recorded.</i>
Measurement functions	Memory recorder (high speed recording), RMS recorder (50/60 Hz, DC only)
Memory capacity	12-bits × 2M-words/ch (1 word = 2 bytes)
Removable storage	CF card TYPE I slot ×1 (Up to 2 GB)
Display	4.3-inch WQVGA-TFT color LCD (480 × 272 dots)
Displayable languages	English, Japanese
Interfaces	USB 2.0 mini-B receptacle ×1, Functionality: Connect the instrument to a PC to send files on the CF card to the PC. The instrument cannot be controlled from a PC.
Printer	N/A
Power supply	AC Adapter Z1005: 100 to 240 VAC (50/60 Hz), 30 VA max. (when using the AC adapter and charging the 9780 with the instrument) Battery Pack 9780: 3 VA, continuous operating time of approx. 2 hr. (25°C reference value; when used with the Z1005, the Z1005 takes priority), charging time of 200 min. using the AC adapter (25°C reference value) (option) External DC power: 10 to 16 V, 10 VA max. (connection cord of 3 m or less is available by special-order)
Dimensions and mass	176 mm (6.93 in)W × 101 mm (3.98 in)H × 41 mm (1.61 in)D, 600 g (21.2 oz) (with the Battery pack 9780 installed)
Included accessories	Instruction manual ×1, Measurement guide ×1, AC adapter Z1005 ×1, Strap ×1, USB cable ×1, Application disk (Dedicated program for the MR8870) ×1, Protection sheet 9809 ×1

- Mode for recording instantaneous waveform and RMS fluctuations
- Save values in real time to a CF card
- Record four channels at once by synchronizing two instruments with the bundled PC application
- Compact and easy to carry
- Easy, intuitive operation
- Fast, 1MS/s performance despite the compact size
- Built-in, compact-yet-sharp QVGA-TFT wide LCD

Model No. (Order Code) **MR8870-20** (2ch, English model)

*Note: Input cords and battery pack are not included. Purchase the cords appropriate for your application separately. The AC Adapter Z1005 is included as standard.*

**Accessories**

**PROTECTION SHEET 9809**  
For LCD protection, pairs of additional sheets can be purchased separately, bundled with instrument

**AC ADAPTER Z1005**  
100 to 240 V AC, bundled with instrument

Other options refer to the detailed catalog

**Options**

**BATTERY PACK 9780**  
NiMH, Charges while installed in the main unit

**SOFT CASE 9812**  
Includes space for small items, Neoprene rubber

**CARRYING CASE 9782**  
Includes compartment for options, resin coated

**PC CARD 2G 9830** (2 GB capacity)  
**PC CARD 1G 9729** (1 GB capacity)  
**PC CARD 512M 9728** (512 MB capacity)

## The Global Standard Recorder for Field and R&D Testing

### MEMORY HiCORDER MR8847A



USB 2.0

LAN

CE

3 Year Warranty

- Supports a wide variety of measurements with a total of 13 plug-in modules
- Generate and record with a single unit
- Direct 1000 V high voltage input testing
- High-speed sampling up to 20MS/s with fully isolated inputs
- 16 analog + 16 logic channels to 64 logic + 10 analog channels
- High-speed sampling with waveform judgement function
- Soil-resistant construction strong against adverse working environments
- Big buttons coated to withstand industrial oil and residue
- Drop-in paper loading and one-touch setup, along with high-speed 50mm/s printing

Model No. (Order Code)	<b>MR8847-51</b> (Max. 16ch, 64MW memory, main unit only)
	<b>MR8847-52</b> (Max. 16ch, 256MW memory, main unit only)
	<b>MR8847-53</b> (Max. 16ch, 512MW memory, main unit only)

Note: Main unit MR8847-51/-52/-53 cannot operate alone. You must install one or more optional input modules in the unit.

Accessories: Instruction manual x1, Measurement guide x1, Application disk (Wave viewer Wv, Communication commands table) x1, Power cord x1, Input cord label x1, USB cable x1, Printer paper x1, Roll paper attachment x2, Ferrite clamp x1

#### Basic specifications (Accuracy guaranteed for 1 years)

Max. Number of channels	16 ch analog + 16 ch logic, or 10 ch analog + 64 ch logic (when used with built-in logic input + plug-in Logic Unit 8973 x 3)
Number of slots	8 slots (Max. 8) [Limitation on number of slots] when using the Current Unit 8971: Max. 4, when using the Logic Unit 8973: Max. 3
Number of logic channels	16 ch logic (logic probe terminal GND share a common GND with chassis) Built-in logic input not available when using DVM Unit MR8990 on slots 1 or 2. [Limitation on using built-in logic input] (with logic measurement ON) • Measurement resolution on slots 1 and 2 is limited up to 12 bits • Cannot use Frequency Unit 8970 on slots 1 or 2.
Measurement ranges (20 div full-scale)	[Analog unit 8966]: 5 mV/div to 20 V/div, 12 ranges, resolution: 1/100 of range (using 12-bit A/D) [High Voltage Unit U8974]: 200 mV/div to 50 V/div, 8 ranges, resolution: 1/1600 of range (using 16-bit A/D)
Max. allowable input	400 V DC (using the 8966), 1000 V DC (using the U8974)
Frequency characteristics	DC to 5 MHz (-3 dB, using the 8966), DC to 100 kHz (using the U8794)
Time axis (Memory function)	5 μs to 5 min/div (100 samples/div) 26 ranges, External sampling (100 samples/div, or free setting), Time axis zoom: x2 to x10 in 3 stages, compression: 1/2 to 1/200 000 in 16 stages
Measurement functions	MEMORY (high-speed recording), RECORDER (real-time recording), X-Y RECORDER (X-Y real-time recording), FFT
Other functions	Waveform judgment (at Memory or FFT function)
Memory capacity	MR8847-51: Total 64 M-words (Memory expansion: none) 32 MW/ch (using 2 Analog channels), to 4 MW/ch (using 16 Analog channels) MR8847-52: Total 256 M-words (Memory expansion: none) 128 MW/ch (using 2 Analog channels), to 16 MW/ch (using 16 Analog channels) MR8847-53: Total 512 M-words (Memory expansion: none) 256 MW/ch (using 2 Analog channels), to 32 MW/ch (using 16 Analog channels)
Removable storage	CF card slot (standard) x1 (up to 2GB, FAT, or FAT-32 format), SSD (128 GB, optional), USB memory stick (USB 2.0)
Printing	216 mm (8.50 in) x 30 mm (98.43 ft), thermal paper roll, Recording speed: Max. 50 mm (1.97 in)/s
Display	10.4 inch TFT color LCD (SVGA, 800 x 600 dots)
Displayable languages	English, Japanese, Korean, Chinese
External interfaces	[LAN] 100BASE-TX (FTP server, HTTP server), [USB] USB2.0 compliant, series A receptacle x1, series B receptacle x1, (File transfer internal drive/CF card to PC, or remote control from PC)
Power supply	100 to 240 V AC, 50/60 Hz (130 VA max., when using printer: 220 VA max.), 10 to 28 V DC (when using the optional factory-installed DC Power Unit 9784)
Dimensions and mass	351 mm (13.82 in) W x 261 mm (10.28 in) H x 140 mm (5.51 in) D, 7.6 kg (268.1 oz) (main unit only)

Option A

Other options: refer to the detailed catalog

**SSD UNIT 88331**  
Specify upon order, built-in type, 128 GB

**DC POWER UNIT 9784**  
Factory-installed option - not user installable, built in on the bottom case. 10 to 28 V DC drive.

**RECORDING PAPER 9231**  
A4 width 216 mm (8.50 in) x 30 mm (98.43 ft), 6 rolls/set

**CARRYING CASE 9783**  
For the MR8847s 8847s, includes compartment for options, hard trunk type for options.

Option B

Install by inserting into the main unit. Can be replaced by user.

- **ANALOG UNIT 8966**  
2 ch, voltage input, 20MS/s (DC to 5 MHz)
- **4CH ANALOG UNIT 8975**  
4 ch, voltage input, 5MS/s (DC to 2 MHz)
- **4CH ANALOG UNIT 8978**  
4 ch, voltage input, 5MS/s (DC to 2 MHz)
- **TEMP UNIT 8967**  
2 ch, thermocouple temperature input
- **HIGH RESOLUTION UNIT 8968**  
2 ch, voltage input, 1MS/s (DC to 100 kHz)
- **STRAIN UNIT 8969**  
2 ch, strain gauge type converter amp

- **FREQ UNIT 8970**  
2 ch, for measurement of frequency, rpm, pulse
- **CURRENT UNIT 8971**: 2 ch, for measuring current using dedicated current sensors
- **3CH CURRENT UNIT 8977**: 3 ch, for measuring current using dedicated current sensors
- **DC/RMS UNIT 8972**: 2 ch, Voltage, 1MS/s (DC to 400 kHz), or RMS (DC/30 to 100 kHz)
- **LOGIC UNIT 8973**: 4 terminals, 16 ch
- **DIGITAL VOLTMETER UNIT MR8990**  
2 ch, DC V input, 0.1 μV resolution, 500 times/s sampling

- **WAVEFORM GENERATOR UNIT MR8790**: 4 ch, ±10 V DC output, 1 Hz to 20 kHz sine waveform output
- **PULSE GENERATOR UNIT MR8791**  
8 ch, 0.1 Hz to 20 kHz pulse, pattern output
- **ARBITRARY WAVEFORM GENERATOR UNIT U8793**  
2 ch, FG function 10 MHz to 100 kHz, Arbitrary waveform generator/D/A refresh rate 2 MHz, Output 15 V
- **HIGH VOLTAGE UNIT U8974**  
2 ch, voltage input, max. 1000 V DC, 700 V AC
- **CHARGE UNIT U8979**  
2 ch, for acceleration measurement, charge output / preamplifier output / voltage output

## Waveform Generation and Recording. Total 64ch, 32 Analog Channels + 32 Logic Channels

### MEMORY HiCORDER MR8827

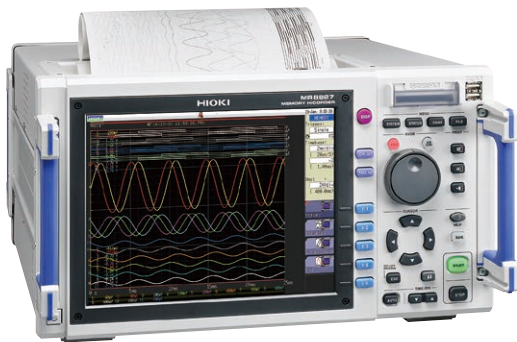

USB 2.0

LAN

CE

3 Year Warranty

- Generate and record waveforms with a single unit
- Output previously recorded problematic waveforms and apply to devices under test to simulate potential issues
- 32 analog + 32 logic channels to 28 analog + 64 logic channels
- High-speed sampling up to 20MS/s with fully isolated inputs
- Safe measurement with all isolated analog inputs
- Large capacity memory of total 512M-words
- Measure various system signals from high voltage to ultra low voltage simultaneously

Model No. (Order Code)	<b>MR8827</b> (Max. 32ch, 512MW memory, main unit only)
------------------------	---

Note: Main unit MR8827 cannot operate alone. You must install one or more optional input modules in the unit.

#### Basic specifications (Accuracy guaranteed for 1 year)

Max. Number of channels	32 ch analog + 32 ch logic, or 28 ch analog + 64 ch logic (when use with built-in logic input + plug-in logic unit 8973 x 2)
Number of slots	16 slots (Max. 16)
Number of logic channels	32 ch logic (logic probe terminal GND share a common GND with chassis) Built-in logic input not available when using DVM Unit MR8990 on slots 1, 2, 9, or 10. [Limitation on using built-in logic input] (with logic measurement ON) • Measurement resolution on slots 1, 2, 9, and slot 10 is limited up to 12 bits • Cannot use Frequency Unit 8970 on slots 1, 2, 9, or 10.
Measurement ranges (20 div full-scale)	[Analog Unit 8966]: 5 mV/div to 20 V/div, 12 ranges, resolution: 1/100 of range (using 12-bit A/D) [High Resolution Unit 8968]: 5 mV/div to 20 V/div, 12 ranges, resolution: 1/1600 of range (using 16-bit A/D)
Max. allowable input	400 V DC (using the 8966/8968)
Frequency characteristics	DC to 5 MHz (-3 dB, using the 8966), DC to 100 kHz (-3 dB, using the 8968)
Time axis (Memory function)	5 μs to 5 min/div, 26 ranges, at 100 points/div resolution
Measurement functions	Memory (high-speed recording), Recorder (real-time recording), X-Y recorder, FFT
Other functions	Numerical calculation, Waveform processing, Waveform judgment (at Memory, or FFT function)
Memory capacity	128M-words/ch (using 4 Analog channels) to 16M-words/ch (using 32 Analog channels), Total capacity 512MW memory
Data storage media	USB memory stick, CF card, Built-in SSD unit (option, 128GB) *Approx. 125 sec. when saving 100 MB of data, *Data of 100 MB in size can record 16,000 div waveforms across 32 channels.
Printing	[Built-in A4-size printer option]: 216 mm (8.50 in) x 30 mm (98.43 ft), thermal paper roll, Recording speed: Max. 50 mm (1.97 in)/s
Display	10.4 inch TFT color LCD (SVGA, 800 x 600 dots)
External interfaces	LAN: 100BASE-TX, USB 2.0 series A receptacle 2 port (for USB memory, mouse) USB 2.0 series B receptacle (for communication with PC, mass storage)
Power supply	100 to 240 V AC, 50/60 Hz (220 VA max., when using printer: 350 VA max.)
Dimensions and mass	401 mm (15.79 in)W x 233 mm (9.17 in)H x 388 mm (15.28 in)D (including protruding parts except handle), 12.6 kg (444.4 oz) (main unit only)
Included accessories	Instruction manual x1, Power cord x1, Application disk (CD-R) x1, Input cord label x1, Printer paper x1 (when ordering printer unit), Roll paper attachment x2 (when ordering printer unit)

Option A

Other options: refer to the detailed catalog

**SSD UNIT 88330**  
Specify upon order, built-in type, 128 GB

**PRINTER UNIT 88350**  
Built-in option. Printing width 200 mm (7.87 inch). Compatible recording paper: Model 9231

**RECORDING PAPER 9231**  
A4 width 216 mm (8.50 in) x 30 mm (98.43 ft), 6 rolls/set

**CARRYING CASE (special order)**  
hard trunk type Inquire with your local Hioki distributor.

Option B

Install by inserting into the main unit. Can be replaced by user.

- **ANALOG UNIT 8966**  
2 ch, voltage input, 20MS/s (DC to 5 MHz)
- **TEMP UNIT 8967**  
2 ch, thermocouple temperature input
- **HIGH RESOLUTION UNIT 8968**  
2 ch, voltage input, 1MS/s (DC to 100 kHz)
- **STRAIN UNIT 8969**  
2 ch, strain gauge type converter amp
- **FREQ UNIT 8970**  
2 ch, for measurement of frequency, rpm, pulse

- **CURRENT UNIT 8971**: 2 ch, for measuring current using dedicated current sensors
- **DC/RMS UNIT 8972**: 2 ch, Voltage, 1MS/s (DC to 400 kHz), or RMS (DC/30 to 100 kHz)
- **LOGIC UNIT 8973**  
4 terminals, 16 ch
- **DIGITAL VOLTMETER UNIT MR8990**  
2 ch, DC V input, 0.1 μV resolution, 300 times/s sampling
- **WAVEFORM GENERATOR UNIT MR8790**: 4 ch, ±10 V DC output, 1 Hz to 20 kHz sine waveform output

- **PULSE GENERATOR UNIT MR8791**  
8 ch, 0.1 Hz to 20 kHz pulse, pattern output
- **ARBITRARY WAVEFORM GENERATOR UNIT U8793**  
2 ch, FG function 10 MHz to 100 kHz, Arbitrary waveform generator/D/A refresh rate 2 MHz, Output 15 V
- **HIGH VOLTAGE UNIT U8974**  
2 ch, voltage input, max. 1000 V DC, 700 V AC
- **CHARGE UNIT U8979**: 2 ch, for acceleration measurement, charge output / preamplifier output / voltage output

## Max. 108 Analog Channels, Reduce Inspection Data Transfer Time to Zero

### MEMORY HiCORDER MR8740T

Recorders  
Data Loggers



- Ideal for multipoint inspection of high performance boards such as ECU
- 108ch analog to 96ch analog + 48ch logic input
- Reduce time required to save to external media to max.1/100 compared with conventional method
- 20 MS/s simultaneous sampling on all channels
- Safe measurement with all analog inputs isolated
- Supports 4K monitor to display multi-channel waveforms without overlapping
- Measure 4 channels with 1 unit (4 ch analog Unit U8975, 4 ch DVM Unit U8991)
- Generate constant voltage, constant current, and simulated resistance (VIR Generator Unit U8794)

Model No. (Order Code) **MR8740-50** (Max. 108ch, 1GW memory, main unit only)

Note: A special option such as an input unit is required for the main unit. Please purchase various common options such as input code separately.

#### Basic specifications (Accuracy guaranteed for 1 year)

Number of input units	Max. 27 slots
Number of channels	[Using the U8975] Max. 108 ch analog, or 96 ch analog + 48 ch logic (when used in combination with U8975 + 8973) [Using the 8966] Max. 54 ch analog, or 48 ch analog + 48 ch logic (when used in combination with 8966 + 8973) *Logic unit 8973 is limited to slots 25 to 27, up to 3 units. *Analog unit channels are isolated from each other and from chassis. Logic unit channels share a common GND with chassis.
Measurement ranges	100 mV to 400 V f.s., 12 ranges, resolution : 1/2000 of range (when using 8966) 4 V to 200 V f.s., 6 ranges, resolution : 1/32000 of range (when using U8975) 100 mV to 1000 V f.s., 5 ranges, resolution : 1/1000 000 of range (when using MR8990) 1 V, 10 V, 100 V f.s., 3 ranges, resolution : 1/1000 000 of range (when using U8991)
Max. allowable input	400 V DC (when using 8966; upper limit voltage that can be applied between input terminals without damage)
Max. rated voltage to earth	300 V AC/DC (input and instrument are isolated; between input channels and chassis; upper limit voltage that can be applied between input channels without damage)
Frequency characteristics	DC to 5 MHz (-3 dB, when using 8966)
Max. sampling speed	20 MS/s, all ch simultaneous, external sampling: 10 MS/s
Measurement functions	Memory (high-speed recording)
Memory capacity	Total of 1 G Word installed, 16 MW/ch (when using 8966), 8 MW/ch (when using U8975 or MR8990), 4 MW/ch (when using U8991)
Internal storage	SSD 480 GB
Removable storage	USB memory stick ×8
Monitor output	VGA, HDMI, Display Port, Recommended resolution 1920 × 1080 dot or more
External interfaces	[LAN] 1000 BASE-T, 100 BASE-TX, 10 BASE-TX (2 port) (DHCP and DNS support, FTP server/client, HTTP server) [USB] USB 3.0 Series A receptacle × 4, USB 2.0 × 4
Power supply	100 to 240 V AC, 50/60 Hz (400 VA max.)
Dimensions and mass	426 mm (16.77 in)W × 177 mm (6.97 in)H × 505 mm (19.88 in)D, 14.0 kg (493.8 oz) (main unit only)
Included accessories	Power cord ×1, Quick Start Manual (booklet) ×1, Instruction Manual (detailed edition)(CD-R) ×1, application disk (CD-R) ×1, blank panel (blank slot only), rack installation hardware

Options	Install by inserting into the main unit. Can be replaced by user.
• ANALOG UNIT 8966 2 ch, voltage input, 20MS/s (DC to 5 MHz)	• FREQ UNIT 8970 2 ch, for measurement of frequency, rpm, pulse
• 4ch ANALOG UNIT U8975 4 ch, voltage input, 5MS/s (DC to 2 MHz)	• CURRENT UNIT 8971 : 2 ch, for measuring current using dedicated current sensors
• 4CH ANALOG UNIT U8978 4 ch, voltage input, 5MS/s (DC to 2 MHz)	• 3CH CURRENT UNIT U8977 3 ch, for measuring current using dedicated current sensors
• TEMP UNIT 8967 2 ch, thermocouple temperature input	• DC/RMS UNIT 8972 2 ch, Voltage, 1MS/s (DC to 400 kHz), or RMS (DC/ 30 to 100 kHz)
• HIGH RESOLUTION UNIT 8968 2 ch, voltage input, 1MS/s (DC to 100 kHz)	• LOGIC UNIT 8973 4 terminals, 16 ch
• STRAIN UNIT U8969 2 ch, strain gauge type converter amp	
	• DIGITAL VOLTMETER UNIT MR8990 2 ch, DC V input, 0.1 μV resolution, 500 times/s sampling
	• DIGITAL VOLTMETER UNIT U8991 4 ch, DC V input, 1 μV resolution, 50 times/s sampling
	• HIGH VOLTAGE UNIT U8974 2 ch, voltage input, max. 1000 V DC, 700 V AC
	• CHARGE UNIT U8979 2 ch, for acceleration measurement, charge output / preamplifier output / voltage output
	• WAVEFORM GENERATOR UNIT MR8790 : 4 ch, ±10 V DC output, 1 Hz to 20 kHz sine waveform output
	• ARBITRARY WAVEFORM GENERATOR UNIT U8793 2 ch, FG function 10 mHz to 100 kHz, Arbitrary waveform generator D/A refresh rate 2 MHz, Output 15 V
	• PULSE GENERATOR UNIT MR8791 8 ch, 0.1 Hz to 20 kHz pulse, pattern output
	• VIR GENERATOR UNIT U8794 8 ch, DC voltage, DC current, resistance (simulated output)



## High-speed/Isolated Multi-channel Measurement System Recorders (rack-mounted)

### MEMORY HiCORDER MR8740, MR8741



MR8740 (54ch Max.)



MR8741 (16ch Max.)



- Introducing the DVM Unit MR8990 with high 24-bit resolution! Perform high-speed, high-accuracy measurement without going through a scanner.
- Support for multi-channel measurement (MR8740: up to 54 ch; MR8741: up to 16 ch)
- Isolated input (between input channels; input-to-chassis isolation: maximum input-to-ground rated voltage of 300 V AC/DC)
- High-speed sampling (max. 20 MS/s; with 54-ch type, simultaneous sampling of up to 32 ch)
- Ideal for rack-mounting (4U height/within 180 mm; display-less, box-type design)
- Display waveforms and make settings on a DVI-D connected monitor and mouse
- Remote measurement via LAN using control commands from a PC

\*Screen monitoring and remote operation available via Internet browser. For faster and more convenient remote operation, we recommend using the Hioki 9333 LAN Communicator.

Model No. (Order Code)	<b>MR8740</b>	(Max. 54ch, 864MW memory, main unit only)
	<b>MR8741</b>	(Max. 16ch, 256MW memory, main unit only)

Note: Main unit MR8740/MR8741 requires input units and other dedicated options. Input cords not included. For more information about input cords and other common options, refer to the detailed catalog.

Options		
Install by inserting into the main unit. Can be replaced by user.		
• <b>ANALOG UNIT 8966</b> 2 ch, voltage input, 20MS/s (DC to 5 MHz)	• <b>DC/RMS UNIT 8972</b> 2 ch, Voltage, 1MS/s (DC to 400 kHz), or RMS (DC/30 to 100 kHz)	• <b>ARBITRARY WAVEFORM GENERATOR UNIT U8793</b> 2 ch, FG function 10 mHz to 100 kHz, Arbitrary waveform generator D/A refresh rate 2 MHz, Output 15 V
• <b>TEMP UNIT 8967</b> 2 ch, thermocouple temperature input	• <b>LOGIC UNIT 8973</b> 4 terminals, 16 ch	• <b>HIGH VOLTAGE UNIT U8974</b> 2 ch, voltage input, max. 1000 V DC, 700 V AC
• <b>HIGH RESOLUTION UNIT 8968</b> 2 ch, voltage input, 1MS/s (DC to 100 kHz)	• <b>DIGITAL VOLTMETER UNIT MR8990</b> 2 ch, DC V input, 0.1 μV resolution, 500 times/s sampling	• <b>CHARGE UNIT U8979</b> 2 ch, for acceleration measurement, charge output / preamplifier output / voltage output
• <b>STRAIN UNIT U8969</b> 2 ch, strain gauge type converter amp	• <b>WAVEFORM GENERATOR UNIT MR8790</b> 4 ch, ±10 V DC output, 1 Hz to 20 kHz sine waveform output	
• <b>FREQ UNIT 8970</b> 2 ch, for measurement of frequency, rpm, pulse	• <b>PULSE GENERATOR UNIT MR8791</b> 8 ch, 0.1 Hz to 20 kHz pulse, pattern output	
• <b>CURRENT UNIT 8971</b> : 2 ch, for measuring current using dedicated current sensors		

#### Basic specifications (Accuracy guaranteed for 1 year)

	MR8740	MR8741
Max. Number of channels	[Block I] 32 ch analog + 8 ch logic, or 29 ch analog + 56 ch logic (when used with built-in logic input + plug-in logic unit 8973 × 3) [Block II] 22 ch analog + 8 ch logic, or 19 ch analog + 56 ch logic (when used with built-in logic input + plug-in logic unit 8973 × 3)	16 ch analog + 16 ch logic, or 10 ch analog + 64 ch logic (when used with built-in logic input + plug-in logic unit 8973 × 3)
Number of slots	[Block I] 16 slots (Max. 16), [Block II] 11 slots (Max. 11) [Limitation on number of slots] when using the Current Unit 8971: Max. 4, When using the Logic Unit 8973: [Block II] Max. 3; cannot use slots 9 to 16 [Block II] Max. 3; cannot use slots 9 to 11	8 slots (Max. 8) [Limitation on number of slots] cannot use Current Unit 8971 When using the Logic Unit 8973: Max. 3
Number of logic channels	[Block I] 8 ch logic (Logic probe terminal GND share a common GND with chassis.) [Block II] 8 ch logic (Logic probe terminal GND share a common GND with chassis.) [Limitation on using built-in logic input] applies to both Block I and Block II (with logic measurement ON) • Measurement resolution on slots 1 and 2 is limited up to 12 bits • Cannot use Frequency Unit 8970 on slots 1 and 2 • When using the DVM Unit MR8990 on slots 1 or 2, cannot use built-in logic input	16 ch logic (Logic probe terminal GND share a common GND with chassis.) on condition that DVM Unit MR8990 is used on slots 1 and 2, cannot use built-in logic input [Limitation on using built-in logic input] (with logic measurement ON) • Measurement resolution on slots 1 and 2 is limited up to 12 bits • Cannot use Frequency Unit 8970 on slots 1 and 2
Measurement ranges (20 div full scale)	5 mV to 20 V/div, 12 ranges, resolution : 1/100 of range (when using 8966) 5 mV to 50 V/div, 5 ranges, resolution : 1/50,000 of range (when using MR8990)	
Max. allowable input	400 V DC (when using 8966; upper limit voltage that can be applied between input terminals without damage)	
Max. rated voltage to earth	300 V AC/DC (input and instrument are isolated; between input channels and chassis; upper limit voltage that can be applied between input channels without damage)	
Frequency characteristics	DC to 5 MHz (-3 dB, when using 8966)	
Time axis (MEMORY operation)	5 μs to 5 min/div; 26 ranges; time axis resolution: 100 points/div; time axis expansion: 3 stages from ×2 to ×10; compression: 13 stages from 1/2 to 1/20,000	
Measurement functions	Memory (high-speed recording), FFT, Recorder	
Memory capacity	16 MW/ch (fixed), total of 864 MW installed	16 MW/ch (fixed), total of 256 MW installed
Removable storage	USB memory stick (USB 2.0)	
Display	None (1 digital DVI terminal per block, 800 × 600 dots)	None (1 digital DVI terminal, 800 × 600 dots)
External interfaces	[LAN] 100Base-TX (DHCP and DNS support, FTP server, HTTP server) [USB] USB 2.0 Series A receptacle × 2 (mouse operation)	
Power supply	100 to 240 V AC, 50/60 Hz (250 VA max.)	100 to 240 V AC, 50/60 Hz (120 VA max.)
Dimensions and mass	426 mm (16.77 in)W × 177 mm (6.97 in)H × 505 mm (19.88 in)D, 10.8 kg (381.0 oz) (main unit only)	350 mm (13.78 in)W × 160 mm (6.30 in)H × 320 mm (12.60 in)D, 5.4 kg (190.5 oz) (main unit only)
Included accessories	Instruction manual ×1, Application disk (Wave viewer Wv, Communication commands table) ×1, Power cord ×1	

# Non-contact Sensing

## Easy CAN Acquisition, Simply Pinch Over Wire Insulation

### NON-CONTACT CAN SENSOR SP7001, SP7002

Recorders  
Peripherals

CAN FD  
CAN



- Acquire CAN FD/CAN data immediately, simply by pinching probes over wire insulation with one-hand
- Eliminate concerns by using non-contact sensing technology
- Use in a diverse array of development and evaluation applications that demand reliability

Model No. (Order Code)	<b>SP7002-90</b> (Supports CAN signals, SP7002, SP7100, SP9200 set)
	<b>SP7001-90</b> (Supports CAN FD / CAN signals, SP7001, SP7100, SP9200 set)
	<b>SP7001-95</b> (Supports CAN FD / CAN signals, SP7001, SP9250, SP7150 set)

#### Basic specifications

Detection method	Capacitive-coupled signal detection *No bare-wire connections
Detectable cables	AVS/AVSS-compliant cables, External diameter: 1.2 mm (0.05 in) to 2.0 mm (0.08 in)
Number of channels	1 CH (SP7150), 2 CH (SP7100)
Compatible communications speeds	SP7001: CAN, CAN FD 125 kbit/s to 3 Mbit/s SP7002: CAN 125 kbit/s to 1 Mbit/s
Total delay time	130 ns (typical)
CAN terminal resistance	60 Ω (typical), built-in
Signal output connector	D-sub 9-pin female
Operating temperature, humidity	Temperature: -40 °C to 85 °C (-40 °F to 185 °F) Humidity: -40 °C to 60 °C (-40 °F to 140 °F), 80% RH or less (with no condensation), 60 °C to 85 °C (140 °F to 185 °F), 60% RH or less (with no condensation)
Power supply	(1) When using the SP7001-95 or SP7150 - USB bus power (5 V DC), Maximum rated power: 8 VA - Z1013 AC Adapter: Rated supply voltage: 100 V to 240 V AC, Maximum rated power: 6 VA (including AC adapter), 1 VA (product only) (2) When using the SP7001-90, SP7002-90, or SP7100 - Z1008 AC Adapter: Rated supply voltage: 100 V to 240 V AC, Maximum rated power: 8 VA (including AC adapter), 3 VA (product only) - External power supply: Rated supply voltage: 10 V to 30 V DC, Maximum rated power: 3 VA
Dimensions and mass	SP7001, SP7002: 44 W × 85 H × 20 D mm (1.73 in. W × 3.35 in. H × 0.79 in. D), 180 g (6.35 oz.), Cable length: 2.5 m (8.20 ft.) SP7100: 55 W × 120 H × 25 D mm (2.17 in. W × 4.72 in. H × 0.98 in. D), 130 g (4.59 oz.), Cable length: 0.3 m (0.98 ft.) SP7150: 47 W × 100 H × 20 D mm (1.85 in. W × 3.94 in. H × 0.79 in. D), 100 g (3.52 oz.), Cable length: 0.3 m (0.98 ft.) SP9250: 10.5 W × 24.5 H × 101 D mm (0.41 in. W × 0.96 in. H × 3.98 in. D), 45 g (1.59 oz.), Cable length: 0.8 m (2.62 ft.) SP9200: φ11.6 × 33.7 H mm (φ0.46 in. × 1.33 in.), 26 g (0.92 oz.), Cable length: 0.5 m (1.64 ft.) *Dimensions do not include cables. Mass includes cables.
Included accessories (SP7001, SP7002)	Quick Start Manual ×1, Operating Precautions ×1
Included accessories (SP7100)	Quick Start Manual ×1, Operating Precautions ×1, Spiral tube ×1, Power cable L9500 ×1, Alligator clip ×1, Ground connection cable ×1
Included accessories (SP7150)	Quick Start Manual ×1, Operating Precautions ×1, Spiral tube (for fixing power cable) ×1, USB Cable L9510 ×1, Ground connection cable ×1, Alligator clip ×1

For more information on product combinations, please see our product catalog:

Single item sales

**SIGNAL PROBE SP9250**  
Trigger Type, Set of 2

**NON-CONTACT CAN SENSOR SP7001**  
Supports CAN FD / CAN signals

**CAN INTERFACE SP7150**  
1 ch, USB power supply

**USB CABLE L9510**  
USB A-C type, Power supply only

**SIGNAL PROBE SP9200**  
Screw type, Set of 2

**NON-CONTACT CAN SENSOR SP7002**  
Supports CAN signals

**CAN INTERFACE SP7100**  
2 ch, power supply +10 V to +30 V DC

**POWER CABLE L9500**  
For supplying 10 V to 30 V DC

Options

**AC ADAPTER Z1013**  
Can be powered from a commercial power supply

**CARRYING CASE C1013**  
Hard case, 2CH can be stored

**AC ADAPTER Z1008**  
Can be powered from a commercial power supply

**SPLIT CABLE SP9900**  
For CH1, CH2 output branch

## Capture Voltage Signals from Outside the Wire Cover

### NON-CONTACT AC VOLTAGE PROBE SP3000



- Observe waveforms with an oscilloscope or a Hioki Memory HiCorder by visualizing signals from electric equipment simply by applying the probe to the wire's insulation
- Capture LIN and other communications signals
- Ideal for applications where:
  - Miniaturization of devices and use of waterproof connectors make it impossible to establish contact with metal terminals
  - Connectors can't be removed due to reduced ability to reproduce phenomena
  - There is need to avoid tearing the wire insulation so as to prevent risk of damage to the sensor due to static electricity



Model No. (Order Code) **SP3000-01** (SP3000, SP9001 bundled model)

Connect to a Memory HiCorder's analog input terminal or oscilloscope. Both the SP3000 amplifier box and SP9001 probe head are necessary to measure. Select Model SP3000-01 for the entire system.

#### Basic specifications (Accuracy guaranteed for 1 year)

<b>[Head of probe] AC VOLTAGE PROBE SP9001</b>	
Measurement method	Capacitive-coupled current cancellation (not suitable for use with bare conductors)
Measurable wire type	Insulated wire
Maximum input voltage	RMS : 30 Vrms or less, Peak : 42.4 Vpeak or less
Dimensions and mass	15.0 mm (0.59 in) W × 13.9 mm (0.55 in) H × 77.4 mm (3.05 in) D, 52 g (1.83 oz) (including cable)
<b>[Main body measuring circuit] NON-CONTACT AC VOLTAGE PROBE SP3000</b>	
Rated measurement voltage	5 V rms (14.14 Vp-p)
Output rate	1 V/V
Rising time	4.5 μs or less
Frequency band	10 Hz to 100 kHz (-3 dB)
Voltage measurement precision	±2.5% rdg ±1% f.s. (0.5 Vrms to 5 Vrms)
Effects of wire under measurement	±5% rdg (Finished outer diameter φ1.0 to 2.5 mm, in a wire rod in conformity with UL1007, UL1015, AV, AVS, AVSS)
Power supply	(1)USB bus power: USB mini receptacle: 5 V ±0.25 V DC, (2)AC Adapter Z1013: 5 V DC, 2.6 A, Rated supply voltage: 100 V to 240 V AC (50 Hz/60 Hz)
Output terminal	Insulated BNC (Measuring device connection side), Output resistance : 50 Ω
Dimensions and mass	120 mm (4.72 in) W × 25 mm (0.98 in) H × 55 mm (2.16 in) D, 160 g (5.64 oz) (including cable)
Included accessories	Ground connection cable (1.5 m) ×1, Alligator clip ×1, USB cable ×1, Instruction manual ×1

Also sold separately

**Non-contact AC Voltage Probe SP3000**  
Sold individually

**AC Voltage Probe SP9001**  
Sold individually

Options

**AC ADAPTER Z1013**  
100 to 240 V AC

**MAGNETIC ADAPTER 9804-02**  
Attaches to the tip of cord, black φ1, φ11 mm (0.43 in)

**CARRYING CASE C1011**  
Includes compartment for options

## Measure High Voltages Safely

### DIFFERENTIAL PROBE P9000



- Compact probe for CAT III 1000V environments
- Wave mode: Observe instantaneous waveforms
- RMS mode: Observe RMS value waveforms
- Principal areas of use
  1. High-voltage battery circuits in EVs, HEVs, and other automobiles
  2. High-voltage circuits in energy-related equipment such photovoltaic cells
  3. Commercial power line circuits (480 Vrms, etc.)
  4. High-voltage surge noise from inverters, motors, solenoids, etc.

Model No. (Order Code) **P9000-01** (For the Memory HiCorder series, Wave only)  
**P9000-02** (For the Memory HiCorder series, Wave/RMS)

Connect to a Memory HiCorder's analog input terminal. Must be powered by an AC adapter, USB bus power, or other suitable power source. Please visit the Hioki website to see the number of P9000 probes that can be used when power is supplied from the standard USB terminal of the Memory HiCorder.

#### Basic specifications (Accuracy guaranteed for 1 year)

	P9000-01	P9000-02
Measurement functions	Waveform monitor output only Frequency characteristics: DC to 100 kHz, -3 dB	Waveform monitor output/AC RMS value output (switchable) Wave mode frequency characteristics: DC to 100 kHz, -3 dB RMS mode frequency characteristics: 30 Hz to 10 kHz, response time: 300 ms (rising) or 500 ms (falling)
Division ratio	1000:1 or 100:1 (user selectable)	
DC amplitude accuracy	±0.5% f.s. (f.s. = 1.0 V; voltage division ratio: 1000:1) (f.s. = 3.5 V; voltage division ratio: 100:1)	
RMS amplitude accuracy (P9000-02 only)	±1% f.s. (30 Hz to 1 kHz non-inclusive, sine wave), ±3% f.s. (1 kHz to 10 kHz, sine wave)	
Input resistance, capacity	Between H and L: 10.5 MΩ, 5 pF or less (at 100 kHz)	
Max. allowable input	1000 V AC/DC	
Max. rated voltage to earth	1000 V AC/DC (CAT III)	
Operating temperature	-40 °C (-40 °F) to 80 °C (176 °F)	
Power supply	(1) AC Adapter Z1008 (100 to 240 V AC, 50/60 Hz), 6 VA (including AC adapter) or 0.9 VA (probe only) (2) USB bus power (5 V DC, USB Micro-B receptacle), 0.8 VA To prevent an electric shock, when supplying power from the USB-microB terminal, please supply from a device which USB's GND terminal of the source device is grounded. (3) External power supply (2.7 V to 15 V DC)	
Dimensions and mass	128 mm (5.04 in)W × 36 mm (1.42 in)H × 22 mm (0.87 in)D, 170 g (6.0 oz) Cord length: Input: 70 cm (2.30 ft) ; output: 1.5 m (4.92 ft)	
Included accessories	Instruction manual ×1, alligator clips ×2, carrying case ×1	

Can also be used with accessories such as L4936/L4937/L4931 as available for other testers.

**AC ADAPTER Z1008**  
100 to 240V AC

**GRABBER CLIP L9243**  
Attaches to the tip of the banana plug cable, Red/Black: 1 each, 185 mm (7.28 in) length, CAT II 1000 V

**CONVERSION CABLE L1011**  
30 cm (0.98 ft) length, covert BNC to wire

**CONVERSION CABLE L1011-10**  
2.4 m (7.87 ft) length, covert BNC to wire

## 3 Kinds of Measurements with a Single Probe

### DIFFERENTIAL PROBE 9322



- Floating measurement of high-voltage waveforms (DC mode)
- Detection of power supply surge noise (AC mode)
- RMS rectified output (RMS mode)
- Main Applications
  1. Measurement of potential differences included in common mode voltages, such as IGBT
  2. Measurement of commercial power line waveforms, such as on 400V power lines
  3. Measurement of high voltage surge noise waveforms
  4. Measurement of the RMS value of inverter outputs, etc.

Model No. (Order Code) **9322** (For the Memory HiCorder series)

The Differential Probe 9322 cannot be used by itself. Please use it in combination with a Hioki Memory HiCorder. The Differential Probe 9322 requires a power supply.  
 \* For the latest information about how to power the 9322 with a Memory HiCorder, please visit the Hioki website.

#### Basic specifications (Accuracy guaranteed for 1 year)

Measurement functions	DC mode: Waveform monitor output, DC to 10 MHz ±3 dB AC mode: Detection of power line surge noise, 1 kHz to 10 MHz ±3 dB (Low frequency cut-off frequency 1 kHz ± 300 Hz) RMS mode: Rectified RMS output of DC and AC voltages, DC, 40 Hz to 100 kHz, Response speed: 200 ms or less (400 V AC)
Max. allowable input	2000 V DC, 1000 V AC
Max. rated voltage to earth	When using the Grabber Clip L9243: 1000 V AC/DC (CAT II) When using alligator clip: 1000 V AC/DC (CAT II), 600 V AC/DC (CAT III)
Output	Voltage division ratio: 1/1000, BNC terminal (DC/AC/RMS 3-mode selectable output)
DC amplitude accuracy	±1 % f.s. (1000 V DC or less), ±3 % f.s. (2000 V DC or less) (f.s.=2000 V DC)
RMS amplitude accuracy	±1 % f.s. (DC, 40 Hz to 1 kHz), ±4 % f.s. (1 kHz to 100 kHz) (f.s.=1000 VAC)
Input resistance, capacity	H-L: 9 MΩ, approx 10 pF (C at 100 kHz) H-case, L-case: 4.5 MΩ, approx 20 pF (C at 100 kHz)
Power supply	+5 to +12 V, less than 300 mA. (DC jack OD 5.5 mm (0.22 in), ID 2.1 mm (0.08 in), (1) Via AC adapter 9418-15, (2) Via Logic terminal on Memory HiCorder through Power cord 9324, (3) Via F/V Unit 8940's sensor terminal through Power cord 9325, (4) Via DC power output terminal attached to the input unit for the 8855 through Power cord 9328, (5) Via the 8860 series dedicated Probe Power Unit 9687 through Power cord 9248, (6) Via MR6000 dedicated Probe Power Unit Z5021 through Power cord 9248
Dimensions and mass	70 mm (2.76 in)W × 150 mm (5.91 in)H × 25 mm (0.98 in)D, 350 g (12.3 oz), Cord length: Input 46 cm (1.51 ft), Output 1.3 m (4.27 ft)
Included accessories	Alligator clips ×1 (red/black set), Grabber clip L9243 ×1 (red/black set), Carrying case C0203 ×1, Instruction manual ×1

#### How to power the 9322 with a Hioki Memory HiCorder

(Caution) To avoid electric shock, connect the power cord supplied with the main unit (Memory HiCorder or AC adapter for the 9322) to a grounded 2-pole outlet.

	Via MR6000 dedicated Probe Power Unit Z5021		Via MR8875 DC power output terminal			Via F/V Unit 8940's <sup>*)</sup> sensor terminal	
	Number of the 9322 connections	Number of the 9322 connections	Required cord	Number of the 9322 connections	Number of current sensors that can be used simultaneously with the 9322		
MR6000	8	N/A	N/A	N/A	N/A		
MR6000-01	(Combined with 9248 cable) <sup>*)</sup>	N/A	N/A	N/A	N/A		
MRB740T	N/A	N/A	N/A	N/A	N/A		
MRB740	N/A	N/A	N/A	N/A	N/A		
MRB741	N/A	N/A	N/A	N/A	N/A		
MRB827	N/A	N/A	N/A	N/A	N/A		
MRB847-01 <sup>*)</sup>	N/A	N/A	N/A	N/A	N/A		
MRB847-02 <sup>*)</sup>	N/A	N/A	N/A	N/A	N/A		
MRB847-03 <sup>*)</sup>	N/A	N/A	N/A	N/A	N/A		
MRB847-51	N/A	N/A	N/A	N/A	N/A		
MRB847-52	N/A	N/A	N/A	N/A	N/A		
MRB847-53	N/A	N/A	N/A	N/A	N/A		
MRB870-20	N/A	N/A	N/A	N/A	N/A		
MRB875	N/A	Unavailable	N/A	N/A	N/A		
MRB880-20	N/A	N/A	N/A	N/A	N/A		

<sup>\*)</sup> Discontinued model

<sup>\*)</sup> When a current sensor is connected to the Probe Power Unit Z5021, or the Current Unit 8971, U8977, the number of the 9322 connection including the current sensor is limited (up to a total of 9 including the current sensor).

**Supplied Accessories**

**GRABBER CLIP L9243**  
Attaches to the tip of the banana plug cable, Red/Black: 1 each, 185 mm (7.28 in) length, CAT II 1000 V

**CARRYING CASE C0203**

**Power supply**

**POWER CORD 9328**  
Power supply to the 9322 through this cord from Memory HiCorder 8855's input units, 15 cm (0.49 ft) length, cannot be used with MR8875

**AC ADAPTER 9418-15**  
100 to 240V AC

**Power supply 2**

When a current sensor is connected to the Probe Power Unit Z5021, or the Current Unit 8971, U8977, the number of the 9322 connection including the current sensor is limited (up to a total of 9 including the current sensor).

**MR6000 dedicated option PROBE POWER UNIT Z5021**  
Number of the 9322 connections : 8 (Combined with 9248 cable)

**POWER CORD 9248**  
Power supply to the 9322 through this cord from the Probe power unit Z5021 /9687, 70 cm (2.30 ft) length

# Recorders Peripherals

## Recorder Peripherals



\* For more information about compatible models, please see individual product catalogs.

Recorders Peripherals

**Voltage measurement Type A**

\* Input voltage is limited to the specifications of the input modules in use  
\* Max. rated voltage to earth is limited to the specifications of the input modules in use

**CONNECTION CORD L9790**  
Flexible  $\phi$  4.1 mm (0.16 in) thin dia., cable allowing for up to 600 V input. 1.8 m (5.91 ft) length  
\* The end clip is sold separately.

**ALLIGATOR CLIP L9790-01**  
Red/black set attaches to the ends of the cables L9790

**CONTACT PIN 9790-03**  
Red/black set attaches to the ends of the cables L9790

**GRABBER CLIP 9790-02**  
Red/black set attaches to the ends of the cables L9790  
\* When this clip is attached to the end of the L9790, input is limited to 300 V. Red/black set.

**Voltage measurement Type B**

\* Input voltage is limited to the specifications of the input modules in use  
\* Max. rated voltage to earth is limited to the specifications of the input modules in use

**CONNECTION CORD L9198**  
 $\phi$  5.0 mm (0.20 in) dia., cable allowing for up to 300 V input. 1.7 m (5.58 ft) length, small alligator clip

**Voltage measurement Type C**

\* Input voltage is limited to the specifications of the input modules in use  
\* Max. rated voltage to earth is limited to the specifications of the input modules in use

**CONNECTION CORD L9197**  
 $\phi$  5.0 mm (0.20 in) dia., cable allowing for up to 600 V input. 1.8 m (5.91 ft) length, a detachable large alligator clips are bundled

**GRABBER CLIP L9243**  
Attaches to the tip of the banana plug cable, Red/Black: 1 each, 185 mm (7.28 in) length, CAT II 1000 V

**Voltage measurement Type D**

\* Max. rated voltage to earth is limited to the specifications of the input modules in use  
\* For a list of compatible Memory HiCorders, please see the product catalog

**10:1 PROBE 9665**  
Max. rated voltage to earth is same as for input module, Frequency characteristics DC to 150 MHz, 1.5 m (4.92 ft) length

**100:1 PROBE 9666**  
Max. rated voltage to earth is same as for input module, Frequency characteristics DC to 200 MHz, 1.5 m (4.92 ft) length

**Voltage measurement Type E**

\* Exclusive options for MR8905 (For MR8875)

**CONNECTION CABLE SET L4940**  
Banana plug - banana cable allowing for up to 600 V input. 1.5 m (4.92 ft) length, red/black each 1

**EXTENSION CABLE SET L4931**  
Expands the length of L4930/L4940, 1.5 m (4.92 ft) length

**ALLIGATOR CLIP SET L4935**  
Attaches to the tip of the L4930/L4940, CAT IV 600V, CAT III 1000V

**GRABBER CLIP L9243**  
Attaches to the tip of the Connection cord or cable, CAT II 1000 V, 185 mm (7.28 in) length

**Non-contact Voltage measuring**

**NON-CONTACT AC VOLTAGE PROBE SP3000-01**  
5 Vrms rated, 10 Hz to 100 kHz bandwidth

**NON-CONTACT AC VOLTAGE PROBE SP3000**  
Sold individually

**AC VOLTAGE PROBE SP9001**  
Sold individually

**High voltage measurement**

\* Maximum input-to-ground rated voltages fall within these products' specifications ranges (and do not affect the connected input units)

**DIFFERENTIAL PROBE 9322**  
For up to 2 kV DC or 1 kV AC. Use with AC Adapter 9418-15

**AC ADAPTER 9418-15**  
100 to 240 V AC

**High voltage measurement**

\* Maximum input-to-ground rated voltages fall within these products' specifications ranges (and do not affect the connected input units)

**DIFFERENTIAL PROBE P9000-01**  
(Waveform mode) For up to 1 kV AC, DC

**DIFFERENTIAL PROBE P9000-02**  
(Waveform / RMS mode selectable) For up to 1 kV AC, DC

**AC ADAPTER Z1008**  
100 to 240 V AC

**Storage media**

\* Supplied with PC Card adapter

**PC Card Precaution**  
Use only CF Cards sold by HIOKI. Compatibility and performance are not guaranteed for CF cards made by other manufacturers. You may be unable to read from or save data to such cards.

**PC CARD 2G 9830**  
2 GB capacity

**PC CARD 1G 9729**  
1 GB capacity

**PC CARD 512M 9728**  
512 MB capacity

**Logic measurement**

**LOGIC PROBE 9320-01**  
4-channel type, for voltage/contact signal ON/OFF detection (response pulse width 500 ns or more, miniature terminal type)

**LOGIC PROBE MR9321-01**  
4 isolated channels, ON/OFF detection of AC/DC voltage (miniature terminal type)

**LOGIC PROBE 9327**  
4-channel type, for voltage/contact signal ON/OFF detection (response pulse width 100 ns or more, miniature terminal type)

Small terminal part of the 9320-01, MR9321-01, and 9327

Large terminal part of the 9320, and MR9321

\*The large terminal type the 9320 and MR9321 can be connected to the discontinued Memory HiCorder models

**Storage media**

**SD MEMORY CARD 2GB Z4001**  
2 GB capacity

**SD MEMORY CARD Z4003**  
8 GB capacity

**USB DRIVE Z4006**  
16 GB, Long-life, High-reliability SLC Flash Memory

**Precaution**  
Use only storage media sold by HIOKI. Compatibility and performance are not guaranteed for storage media made by other manufacturers. You may be unable to read from or save data to such cards.

**Connection Cables**

**OUTPUT CORD L9094**  
 $\phi$  3.5 mm (0.14 in) dia. mini plug to banana, 1.5 m (4.92 ft) length

**OUTPUT CORD L9095**  
Connect to BNC terminal, 1.5 m (4.92 ft) length

**OUTPUT CORD L9096**  
Connect to terminal block, 1.5 m (4.92 ft) length

**CONNECTION CORD 9165**  
Cord has metallic BNC connectors at both ends, use at metallic terminal, 1.5 m (4.92 ft) length

**CONNECTION CORD 9166**  
Metal BNC to clip, 1.5 m (4.92 ft) length

**CONVERSION ADAPTOR 9199**  
Receiving side banana (female), output BNC (male)

**CONNECTION CORD L9217**  
Cord has insulated BNC connectors at both ends, 1.6 m (5.25 ft) length

**LAN CABLE 9642**  
Straight Ethernet cable, supplied with straight to cross conversion adapter, 5 m (16.41 ft) length

**Recording Papers**

**RECORDING PAPER 9234**  
For the MR8880 (MR9000), 8860/8861 (8995-01), 8420/21/22 (8992), 8807/08 (8992), 8807-50/8808-50 (8992), 8714/15  
Roll type A6 width 112 mm (4.41 in)  $\times$  18 mm (59.06 ft), 10 rolls/set

**RECORDING PAPER 9232**  
For the 8804/05/06, 3193 (9604), 3194 (9604)  
Roll type, 74 mm (2.91 in)  $\times$  10 m (32.81 ft), 10 rolls/set

**RECORDING PAPER 9231**  
For the MR8847A/MR8847/ MR8827, 8860-50/8861-50 (8995), 8855/47/46/45/42/41/40  
Roll type A4 width 216 mm (8.50 in)  $\times$  30 m (98.43 ft), 6 rolls/set

**RECORDING PAPER 9229**  
For the 8825/8826  
Roll type, 264 mm (10.39 in)  $\times$  30 m (98.43 ft), 6 rolls/set

**9229-01**  
For the 8825/8826  
Perforated roll type, 264 mm (10.39 in)  $\times$  30 m (98.43 ft), 6 rolls/set

**RECORDING PAPER 9221**  
For the 8801s, 8810s, 8830s, 8835s, 8851/52/53, 8710, 3195, 3620  
Roll type, 110 mm (4.33 in)  $\times$  30 m (98.43 ft), 10 rolls/set

**RECORDING PAPER 9235**  
For the 8205 (-10), 8206 (-10)  
Roll type, 74 mm (2.91 in)  $\times$  15 m (49.22 ft), 10 rolls/set

**9236-01**  
For the 8205 (-10), 8206 (-10)  
Climate-resistant roll type, 74 mm (2.91 in)  $\times$  15 m (49.22 ft), 10 rolls/set

**RECORDING PAPER SE-10Z-2**  
For the PR8111/12, EPR-3000 series, EPR-3500 series, EPR-10B  
Folding, 170 mm (6.69 in)  $\times$  15 m (49.22 ft), 10 books/set

**RECORDING PAPER SE-10**  
For the PR8111/12, EPR-3000 series, EPR-3500 series, EPR-10B  
Roll type, 170 mm (6.69 in)  $\times$  20 m (65.62 ft), 10 rolls/set

**SF-10CXZ-35**  
For the INR-9000, PRR-5000  
Folding, 250 mm (9.84 in)  $\times$  35 m (114.84 ft), 1 book

**SF-10PXZ-45**  
For the PRR-5000  
Folding, 250 mm (9.84 in)  $\times$  45 m (147.65 ft), 1 book

**SG-10Z**  
For the FBR-250 series  
Folding, 250 mm (9.84 in)  $\times$  20 m (65.62 ft), 10 books/set

**SH-OZ-T1**  
For the PSR-2101  
Folding, 30 m (98.43 ft), 10 books/set

### For high-precision current measurement

In order to use the high precision current sensor, CT955x and connection cord are required separately

\*The separately available Conversion Cable CT9901 is required in order to use a high-precision current sensor equipped with ME15W (12-pin) terminal with the Current Measuring Module 8971 (which is designed for use with the MR8847, MR8827, and MR8740).  
\*The separately available Conversion Cable CT9901 and Conversion Cable 9318 are required in order to use a high-precision current sensor equipped with ME15W (12-pin) terminal with the F/V Unit (which is designed for use with the 8860 and 8861).  
\*While the CT955x is not required in order to use a sensor equipped with PL23 (10-pin) terminal with the 8971 or 8940, the Conversion Cable 9318 (which comes with the 8971) is required for that setup.

#### Input units for current sensors

- CURRENT UNIT 8971**  
For MR8847, MR8827, MR8740
- CONVERSION CABLE 9318**  
Connect current sensor equipped with PL23 (10-pin) terminal to 8971/40511, 38 cm (14.96 in) length
- ME15W (12pin) - PL23 (10-pin) conversion**
- CONVERSION CABLE CT9901**  
Convert ME15W (12-pin) terminal to PL23 (10-pin) terminal

\*A separate power supply (CT955x) is required in order to use a high-precision current sensor. \*Only sensors with ME15W (12-pin) terminals can be connected to the CT955x. \*The separately available Conversion Cable CT9900 is required in order to use a sensor with PL23 (10-pin) terminal.

#### POWER SUPPLY for Current Sensors

- SENSOR UNIT CT9555**  
1ch, with waveform output
- SENSOR UNIT CT9556**  
1ch, with waveform/RMS output
- SENSOR UNIT CT9557** 4ch, with waveform/total waveform/total RMS output
- CONNECTION CORD L9217**  
Cord has insulated BNC connectors at both ends, 1.6 m (5.25 ft) length

#### PL23 (10-pin) - ME15W (12-pin) conversion

- CONVERSION CABLE CT9900**  
Convert PL23 (10-pin) terminal to ME15W (12-pin) terminal

#### Connection between Memory HiCorder and high precision current sensor

- **MR8880/MR8875/MR8870**  
• High precision current sensor (ME15W) + CT955x + BNC cable → MR8880  
• High precision current sensor (PL23) + CT9900 + CT955x + BNC cable → MR8880
- **MR6000/MR8847A/MR8827/MR8740**  
• High precision current sensor (ME15W) + CT9901 + 9318 → Current Unit 8971  
• High precision current sensor (ME15W) + CT955x + BNC cable → Except for Current Unit 8971  
• High precision current sensor (PL23) + 9318 → Current Unit 8971  
• High precision current sensor (PL23) + CT9900 + CT955x + BNC cable → Except for Current Unit 8971
- **MR8741**  
• High precision current sensor (ME15W) + CT955x + BNC cable → Except for Current Unit 8971  
• High precision current sensor (PL23) + CT9900 + CT955x + BNC cable → Except for Current Unit 8971  
\*Current Unit 8971 can not use for MR8741
- **8860/8861**  
• High precision current sensor (ME15W) + CT9901 + 9705 + 9318 → F/V Unit 8940  
• High precision current sensor (ME15W) + CT955x + BNC cable → Except for F/V Unit 8940  
• High precision current sensor (PL23) + 9705 + 9318 → F/V Unit 8940  
• High precision current sensor (PL23) + CT9900 + CT955x + BNC cable → Except for F/V Unit 8940

### For easy measurement of AC/DC currents

To use these current sensors, a separate power supply (CT7290 or other) is required

#### 100 to 2000 A (Medium speed)

- AC/DC CURRENT SENSOR CT7631 (AUTO-ZERO CT7731)**  
DC, 1 Hz to 10 kHz (5 kHz), 100 A, 1 mV/A output
- AC/DC CURRENT SENSOR CT7636 (AUTO-ZERO CT7736)**  
DC, 1 Hz to 10 kHz (5 kHz), 600 A, 1 mV/A output
- AC/DC CURRENT SENSOR CT7642 (AUTO-ZERO CT7742)**  
DC, 1 Hz to 10 kHz (5 kHz), 2000 A, 1 mV/A output
- DISPLAY UNIT CM7290**  
Measurement, display, signal output in combination with CT 7000s
- DISPLAY UNIT CM7291**  
Built in Bluetooth® wireless technology

#### Up to 8000 A (High precision)

Aggregate and measure large currents in multi-cable circuits

Use multiple AC/DC Current Sensor CT6877A units with the Sensor Unit CT9557 to measure currents of up to 8000 A in multi-cable circuits.

- AC/DC CURRENT SENSOR CT6877A**  
High-precision pull-through type, observe waveforms from DC to distorted AC, DC to 1 MHz band width, 2000 A input, ±0.04% amplitude accuracy, ±0.08° phase accuracy, ME15W terminal. (±0.1% amplitude accuracy, ±0.18° phase accuracy in case of the addition wave output)

#### Up to 2000 A (High precision)

- AC/DC CURRENT SENSOR CT6877A**  
High-precision pull-through type, observe waveforms from DC to distorted AC, DC to 1 MHz band width, 2000 A input, ±0.04% amplitude accuracy, ±0.08° phase accuracy, ME15W terminal

#### Up to 1000 A (High precision)

- AC/DC CURRENT SENSOR CT6876A**  
High-precision pull-through type, observe waveforms from DC to distorted AC, DC to 1.5 MHz band width, 1000 A input, ±0.04% amplitude accuracy, ±0.08° phase accuracy, ME15W terminal
- AC/DC CURRENT PROBE CT6846A**  
Monitor the waveforms of DC to distorted AC current, DC to 100 kHz band width, 1000 A input, ±0.2% amplitude accuracy, ±0.1° phase accuracy, ME15W terminal

#### Up to 500 A (High precision)

- AC/DC CURRENT SENSOR CT6875A**  
High-precision pull-through type, observe waveforms from DC to distorted AC, DC to 2 MHz band width, 500 A input, ±0.04% amplitude accuracy, ±0.1° phase accuracy, ME15W terminal
- AC/DC CURRENT PROBE CT6844A**  
Monitor the waveforms of DC to distorted AC current, DC to 500 kHz band width, 500 A input, ±0.2% amplitude accuracy, ±0.1° phase accuracy, ME15W terminal
- AC/DC CURRENT PROBE CT6845A**  
Monitor the waveforms of DC to distorted AC current, DC to 200 kHz band width, 500 A input, ±0.2% amplitude accuracy, ±0.1° phase accuracy, ME15W terminal

#### Up to 200 A (High precision)

- AC/DC CURRENT SENSOR CT6873**  
High-precision pull-through type, observe waveforms from DC to distorted AC, DC to 10 MHz band width, 200 A input, ±0.03% amplitude accuracy, ±0.05° phase accuracy, ME15W terminal
- AC/DC CURRENT SENSOR CT6863-05**  
High-precision pull-through type, observe waveforms from DC to distorted AC, DC to 500 kHz band width, 200 A input, ±0.05% amplitude accuracy, ±0.2° phase accuracy, ME15W terminal
- AC/DC CURRENT PROBE CT6843A**  
Monitor the waveforms of DC to distorted AC current, DC to 700 kHz band width, 200 A input, ±0.2% amplitude accuracy, ±0.1° phase accuracy, ME15W terminal
- CLAMP ON SENSOR 9272-05**  
Observe waveforms of distorted AC (not for DC), 1 Hz to 100 kHz band width, 20/200 A input, ±0.3% amplitude accuracy, ±0.2° phase accuracy, ME15W terminal

#### Up to 50 A (High precision)

- AC/DC CURRENT SENSOR CT6872**  
High-precision pull-through type, observe waveforms from DC to distorted AC, DC to 10 MHz band width, 50 A input, ±0.03% amplitude accuracy, ±0.05° phase accuracy, ME15W terminal
- AC/DC CURRENT SENSOR CT6862-05**  
High-precision pull-through type, observe waveforms from DC to distorted AC, DC to 1 MHz band width, 50 A input, ±0.05% amplitude accuracy, ±0.2° phase accuracy, ME15W terminal
- AC/DC CURRENT PROBE CT6841A**  
Monitor the waveforms of DC to distorted AC current, DC to 2 MHz band width, 20 A input, ±0.2% amplitude accuracy, ±0.1° phase accuracy, ME15W terminal

### For wide-band current observation

To use these current sensors, a separate power supply (3272 or other) is required

#### POWER SUPPLY \*Required when using Current Probe 3270 series

- POWER SUPPLY 3272**  
The CT6700, CT6701: up to 2 units  
The 3273-50, 3274, 3275 or 3276: up to 1 unit (May be used with up to 2 units on condition that the measurement current is sufficiently low.)
- POWER SUPPLY 3269**  
The CT6710, CT6711: up to 2 units  
The CT6700, CT6701, 3273-50, 3274, 3275 or 3276: up to 4 units

#### 1 mA order to 500 A (High speed)

- CURRENT PROBE CT6700**  
Wide DC to 50 MHz bandwidth, 1 mA-class to 5 A rms
- CURRENT PROBE CT6701**  
Wide DC to 120 MHz bandwidth, 1 mA-class to 5 A rms
- CLAMP ON PROBE 3273-50**  
Wide DC to 50 MHz bandwidth, 10 mA-class to 30 A rms
- CLAMP ON PROBE 3276**  
Wide DC to 100 MHz bandwidth, 10 mA-class to 30 A rms
- CLAMP ON PROBE 3274**  
Wide DC to 10 MHz bandwidth, max. 150 A rms
- CLAMP ON PROBE 3275**  
Wide DC to 2 MHz bandwidth, max. 500 A rms
- CURRENT PROBE CT6710**  
Wide DC to 50 MHz bandwidth, 0.5 A-class to 30 A rms
- CURRENT PROBE CT6711**  
Wide DC to 120 MHz bandwidth, 0.5 A-class to 30 A rms

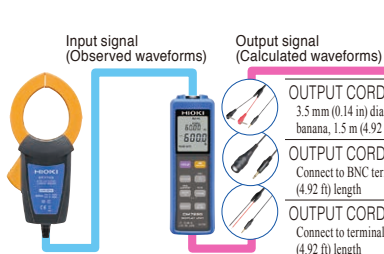

### For easy measurement of AC currents

Other than CT9667, separate power supply is not required

#### 500 A to 5000 A \*For commercial power lines, 50/60Hz

- CLAMP ON PROBE 9018-50**  
Good phase characteristics, Frequency characteristics: 40 Hz to 3 kHz, 10 to 500 A AC range, output 0.2 V AC f.s.
- CLAMP ON PROBE 9132-50**  
Frequency characteristics: 40 Hz to 1 kHz, 20 to 1000 A AC range, output 0.2 V AC f.s.
- AC FLEXIBLE CURRENT SENSOR CT9667-01/-02/-03**  
10 Hz to 20 kHz, 5000 A / 500 A AC, 500 mV/f.s. output, φ 100 to 254 mm (3.94 to 10.00 in), 3 loop diameters

### For measurement of AC leak currents

Battery operated (Long-term observation is possible with separate power supply)

#### Leak Current \*For commercial power lines, 50/60 Hz

- AC LEAKAGE CLAMP METER CM4003**  
6 mA range (1 μA resolution) to 200 A range, with WAVE/RMS output, CONNECTION CABLE L9097 (output terminal: BNC, power terminal: USB-C, 1.5 m (4.92 ft.) length) is included
- AC ADAPTER Z1013**  
100 V to 240 V AC

## Measurement support software

### MR6000 Viewer

Load measurement data on a computer to display waveforms and perform calculations.

- Take advantage of functionality similar to the MR6000 on a computer, including numerical calculations, waveform processing, and FFT calculations.  
\*Some functions limited.
- Ideal for report creation



Supported products (discontinued):

MR6000, MR6000-01, MR8847A, MR8827, MR8740, MR8741

Available for download free of charge from Hioki's website.

Operating environment:

Computer running Windows 10 (64-bit)

For other information and system requirements, please see the user manual.

### WAVE PROCESSOR 9335

Display, convert, calculate, and print waveforms with a PC

- Display waveform screens, X-Y graphs, and numerical results
- Rich printing and hard copy functions to assist in creating reports
- Save in CSV format and export to spreadsheet application (EXCEL)

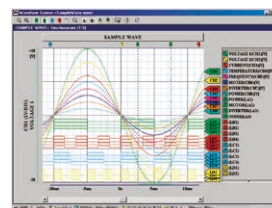

Supported products:

Model MR6000, MR6000-01, MR8880, MR8875, MR8870, MR8847-01/-02/-03, MR8847-51/-52/-53, MR8827, Model 8861-50/8860-50 (not compatible with dual time-axis data), 8870, 8855, 8847, 8842, 8841, 8840, 8835-01, 8835, 8826, 8825, 8808, 8807, 8808-51, 8807-51 (excluding harmonic analysis function), MR8730, MR8731, MR8740, MR8740-50, MR8741, 8730, 8731, 8720, 8715, 8714

Model No. (Order Code) 9335

Operating environment:

Computer running under Windows 10/8/7 (32/64-bit)

### LAN COMMUNICATOR 9333

Remote control via LAN Memory HiCorders and PC Communications

- Auto save a waveform data to the PC
- Remote control with the PC via LAN
- Save in CSV format and export to spreadsheet application

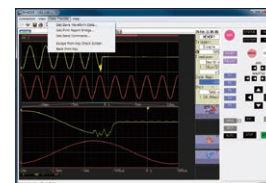

Supported products:

Model MR8847-51/-52/-53, MR8827 (Ver. 1.00 or later), MR8740 (Ver. 3.12 or later), MR8741 (Ver. 2.12 or later), MR8847-01/-02/-03, 8847 (Ver. 3.07 or later), 8826 (Ver. 2.30 or later)

Model No. (Order Code) 9333

Operating environment:

Computer running under Windows 10/8/7 (32/64-bit), Vista (32-bit), XP

## Other compatible software (third party)

### FlexPro

FlexPro - Advanced Software for Analysis and Presentation of Memory HiCorder Data

- Search through large amounts of data at lightning fast speeds for the MEMORY HiCORDER Series
- Use your analyses on any number of measurements at the click of a button.
- Share your analysis templates with colleagues over your network.



Supported products : MR6000, MR8827, MR8740, MR8741, MR8847A, MR8875, LR8450, LR8432, LR8431, LR8410, 8423

Model	FlexPro	Software (third party)
More information: Weisang GmbH (Germany) <a href="http://www.weisang.com/">http://www.weisang.com/</a>		

### OS-2000

OS-2000 - Freely edit large data that cannot be handled by Excel

- Freely edit large data that cannot be handled by Excel
- Simultaneously display the waveforms which have different frequencies

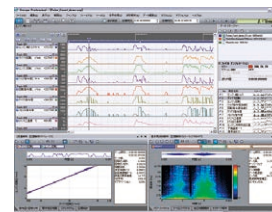

Supported products : MR6000, MR6000-01, MR8827, MR8740, MR8741, MR8847-51, MR8847-52, MR8847-53, MR8875, MR8880, MR8870

Model	OS-2000	Software (third party)
More information: Ono Sokki Co., Ltd. (Japan) <a href="https://www.onosokki.co.jp/English/hp_e/products/keisoku/data/os2000.htm">https://www.onosokki.co.jp/English/hp_e/products/keisoku/data/os2000.htm</a>		

### NI DIAdem

NI DIAdem - Analyze the data measured by Memory HiCorder

- Data management, display, analysis and report creation with interactive operation.
- Synchronous playback and analysis function of video and measurement data.

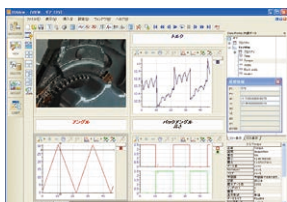

Supported products : MR6000, MR6000-01, MR8827, MR8740, MR8741, MR8847-51, MR8847-52, MR8847-53 (MR8990 is not supported), MR8875, MR8880, 8423, LR8400, LR8401, LR8402, LR8410, LR8416

Model	NI DIAdem	Software (third party)
More information: imc Test & Measurement GmbH (Germany) <a href="https://www.imc-tm.com/">https://www.imc-tm.com/</a>		

### FAMOS

FAMOS - The software for engineers, which can quickly analyze measured data

- Load, display, and analyze the data measured by Memory HiCorder.
- Generate a report.
- More than 400 function libraries, like a FFT.

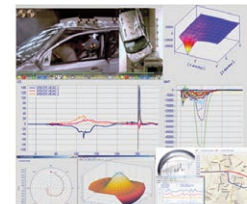

Supported products : MR6000, MR6000-01

(Download a free MR6000 import filter free of charge from Hioki's website.)

Model	FAMOS	Software (third party)
More information: imc Test & Measurement GmbH (Germany) <a href="https://www.imc-tm.com/">https://www.imc-tm.com/</a>		

## Identify Fungal Growth Rate at a Glance! Prevent Fungal Occurrence in Business Critical Locations

### WIRELESS FUNGAL LOGGER LR8520



\* Humidity sensor is sold separately. (Sensor guaranteed for 1 year.)

- High-precision  $\pm 3\%$  rh humidity sensors
- Calculate and display fungal index\*<sup>1</sup> and growth prediction
- Measure temperature and humidity other than fungal index and growth prediction
- Compact 1ch logger (Temperature/Humidity each 1 ch input)
- Download measurement data to a tablet or computer with Bluetooth® wireless technology or capture in real time with the LR8410
- Three-way power (AC adapter, AA alkaline batteries, or external 5 to 13.5 V power supply)
- Store 500,000 data points per channel

Model No. (Order Code) **LR8520** (humidity sensor is sold separately)

\*<sup>1</sup> Fungal index was proposed by the late Keiko Abe, Doctor of Agriculture (Japanese Patent Number 2710903). The LR8520 alone is not capable of making measurements - please also purchase applicable sensor. Only the temperature and humidity sensors affect the measurement accuracy and are subject to calibration. The LR8520 logger does not require calibration. For the latest information about countries and regions where wireless operation is currently supported, please visit the Hioki website. Bluetooth® is a trademark of Bluetooth SIG, Inc. and licensed for use by HIOKI E.E. CORPORATION.

■ Data can be downloaded using Hioki's tablet and smartphone app (for Android devices). Search for "HIOKI" and download the Wireless Logger Collector!



#### ■ Basic specifications

Functionality	[Used as standalone product (Data collected manually)] Windows PC or Windows tablet (CD-R with software included) Android smartphone or Android tablet terminal (Download app from Google Play) *Communication range varies with the performance of the computer or tablet (up to a line-of-sight distance of roughly 30 m) [Used as an input module (Real-time measurement)] Device can be used as an LR8410 logging module to record and display data in real time and to control up to 7 units, Communication distance: 30 m
Number of channels	1 temperature channel + 1 humidity channel (Humidity sensor Z2010 or Z2011 is required (sold separately))
Display items	Temperature, humidity, fungal index (0 to 200), growth prediction (5 levels)
Measurable range	[Temperature] -40°C to 80°C, Range 100°C f.s., Max. resolution 0.1°C [Humidity] 0% to 100% RH, Range 100% RH f.s., Max. resolution 0.1% RH
Measurement accuracy (using Z2010/Z2011)	[Temperature] $\pm 0.5^\circ\text{C}$ (10°C to 60°C), If outside above temperature range: Add 0.015 °C/°C (-40 °C to 10 °C) or 0.02 °C/°C (60 °C to 80 °C) [Humidity] $\pm 3\%$ RH (20°C to 30 °C, 20% to 90% RH), Hysteresis: $\pm 1\%$ RH (Added to the humidity measurement accuracy)
Other functions	Measurement value, Date, Time, Number of recorded data, Maximum value, Minimum value, Average value, Alarm, Scaling, Recording operation hold function, Erroneous operation prevention, Comment recording function, Power saving function, Authentication function, Free run
Recording	[Capacity] 500,000 data items for each channel [Mode] Instantaneous value [Interval] 0.5 sec to 30 sec, 1 min to 60 min, 14 selections
Power supply	AC Adapter Z2003 (100 to 240 V AC, 50/60 Hz), AA alkaline batteries (LR6) × 2, External power 5 to 13.5 V DC (can also be supplied from USB bus power via a conversion cable)
Continuous operating time	3.5 months (Recording interval of 1 min, Bluetooth® OFF), 20 days (Recording interval of 1 sec, Bluetooth® ON), 5 days (Recording interval of 0.5 sec, during real-time measurement with the LR8410)
Dimensions and mass	85 mm (3.35 in) W × 61 mm (2.40 in) H × 31 mm (1.22 in) D (Excluding protrusions), 95 g (3.3 oz) (Not including the battery)
Included accessories	CD-R (Instruction Manual, Logger Utility, Wireless Logger Collector) × 1, Measurement Guide × 1, Caution for Using Radio Waves × 1, AA alkaline batteries (LR6) × 2, Connection cable L1010 × 1

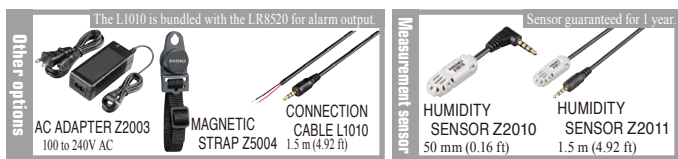

## Easy, wireless collection of a variety of data types, Voltage and K and T thermocouple input with a single device

### WIRELESS VOLTAGE/ TEMP LOGGER LR8515



\* Temperature sensor is sold separately

- A single device to measure everything from the minute voltages of pyranometers or heat flow sensors to battery voltage to temperature
- Compact, two-channel model fits where other devices don't
- Download measurement data to a tablet or computer with Bluetooth® wireless technology or capture in real time with the LR8410
- Three-way power (AC adapter, AA alkaline batteries, or external 5 to 13.5 V power supply)
- Store 500,000 data points per channel

Model No. (Order Code) **LR8515** (2 ch, sensor is sold separately)

For the latest information about countries and regions where wireless operation is currently supported, please visit the Hioki website. Bluetooth® is a trademark of Bluetooth SIG, Inc. and licensed for use by HIOKI E.E. CORPORATION.

■ Data can be downloaded using Hioki's tablet and smartphone app (for Android devices). Search for "HIOKI" and download the Wireless Logger Collector!



#### ■ Basic specifications (Accuracy guaranteed for 1 year)

Functionality	[Used as standalone product (Data collected manually)] Windows PC or Windows tablet (CD-R with software included) Android smartphone or Android tablet terminal (Software can be downloaded free of charge from Google Play.) *Communication range varies with the performance of the computer or tablet (up to a line-of-sight distance of roughly 30 m) [Used as logging module (Real-time measurement)] Device can be used as an LR8410 logging module to record and display data in real time and to control up to 7 units, Communication distance: 30 m
Number of channels	2 ch (isolated; select voltage of thermocouple for each channel), Input terminals: M3 screw type terminal block
Measurement items	Voltage/ Thermocouple (K, T)
Maximum input voltage	$\pm 50$ V DC, Max. inter-channel voltage 60 V DC
Measurement range	[Voltage] $\pm 50$ mV to $\pm 50$ V, Max. resolution 0.01 mV [Thermocouple] -200 °C to 999.9 °C, Thermocouples (K, T), Max. resolution 0.1 °C
Measurement accuracy	[Voltage] $\pm 0.05$ mV (50 mV range) [Thermocouple] $\pm 0.8^\circ\text{C}$ (Thermocouple K -100 °C to 999.9 °C) *Reference junction compensation: Switchable between internal and external *Reference junction compensation accuracy: $\pm 0.5^\circ\text{C}$ (When using internal compensation, add to thermocouple measurement accuracy) *Temperature characteristics: Add (measurement accuracy $\times 0.1$ ) / °C to measurement accuracy.
Display items	Measurement value, date, time, number of recorded data, maximum value, minimum value, and average value
Functions	Alarm, Scaling, Recording operation hold function, Erroneous operation prevention, Comment recording function, Power saving function, Authentication function, Free run
Recording	[Capacity] 500,000 data items for each channel [Mode] Instantaneous value [Interval] 0.1 to 30 sec, 1 to 60 min, 16 selections
Power source	AC Adapter Z2003 (AC100 V to 240 V, 50 Hz/60 Hz), AA alkaline batteries (LR6) × 2, External power DC5 V to 13.5 V (can also be supplied from USB bus power, with a conversion cable)
Continuous operating time	2.5 months (Recording interval of 1 min, Bluetooth® OFF), 7 days (Recording interval of 1 sec, Bluetooth® ON), 2 days (Recording interval of 0.1 sec, during real-time measurement with the LR8410)
Dimensions and mass	85 mm (3.35 in) W × 75 mm (2.95 in) H × 38 mm (1.50 in) D, 126 g (4.4 oz) (Not including the battery)
Included accessories	CD-R × 1 (Instruction Manual, Logger Utility, Wireless Logger Collector), Measurement Guide × 1, Caution for Using Radio Waves × 1, AA alkaline batteries (LR6) × 2



Easy, wireless collection of a variety of data types; ideal for managing environmental temperature and humidity at production plants and agricultural sites

## WIRELESS HUMIDITY LOGGER LR8514



\*Temperature and humidity sensor is sold separately (Sensor guaranteed for 1 year.)

- High-precision,  $\pm 3\%$  RH humidity sensor
- Convenient for simultaneously recording and comparing temperature and humidity readings at 2 locations
- Compact, two-channel model fits where other devices don't
- Download measurement data to a tablet or computer with Bluetooth® wireless technology or capture in real time with the LR8410
- Three-way power (AC adapter, AA alkaline batteries, or external 5 to 13.5 V power supply)
- Store 500,000 data points per channel

Model No. (Order Code) **LR8514** (2 ch, sensor is sold separately)

Note: The LR8514 alone is not capable of making measurements. Only the temperature and humidity sensors affect the measurement accuracy and are subject to calibration. The LR8514 logger does not require calibration. For the latest information about countries and regions where wireless operation is currently supported, please visit the Hioki website. Bluetooth® is a trademark of Bluetooth SIG, Inc. and licensed for use by HIOKI E.E. CORPORATION.

■ Data can be downloaded using Hioki's tablet and smartphone app (for Android devices). Search for "HIOKI" and download the Wireless Logger Collector!



### Basic specifications

Functionality	[Used as standalone product (Data collected manually)] Windows PC or Windows tablet (CD-R with software included) Android smartphone or Android tablet terminal (Software can be downloaded free of charge from Google Play.) *Communication range varies with the performance of the computer or tablet (up to a line-of-sight distance of roughly 30 m) [Used as logging module (Real-time measurement)] Device can be used as an LR8410 logging module to record and display data in real time and to control up to 7 units, Communication distance: 30 m
Number of channels	2 ch for temperature + 2 ch for humidity (2 sensors can be attached)
Measurement items	Temperature, Humidity
Measurable Range	[Temperature] -40 °C to 80 °C, Range 100°C f.s., Max. resolution 0.1°C [Humidity] 0 to 100% RH, Range 100% RH f.s., Max. resolution 0.1%RH
Measurement accuracy (using Z2010/ Z2011)	[Temperature basic accuracy] $\pm 0.5$ °C (10 to 60 °C) *If outside above temperature range: Add 0.015 °C / °C (-40 to 10 °C) or 0.02 °C / °C (60 to 80 °C) [Humidity basic accuracy] $\pm 3\%$ RH (20 to 30 °C, 20 to 90% RH), Hysteresis: $\pm 1\%$ RH (Added to the humidity measurement accuracy)
Display items	Measurement value, date, time, number of recorded data, maximum value, minimum value, and average value
Functions	Alarm, Scaling, Recording operation hold function, Erroneous operation prevention, Comment recording function, Power saving function, Authentication function, Free run
Recording	[Capacity] 500,000 data items for each channel [Mode] Instantaneous value [Interval] 0.5 to 30 sec, 1 to 60 min, 14 selections
Power source	AC Adapter Z2003 (100 to 240 V AC, 50/60 Hz), AA alkaline batteries (LR6) $\times 2$ , External power 5 to 13.5 V DC (can also be supplied from USB bus power, with a conversion cable)
Continuous operating time ([Capacity] 500,000 data items for each channel) (23°C)	3.5 months (Recording interval of 1 min, Bluetooth® OFF), 20 days (Recording interval of 1 sec, Bluetooth® ON), 5 days (Recording interval of 0.5 sec, during real-time measurement with the LR8410)
Dimensions and mass	85 mm (3.35 in) W $\times$ 61 mm (2.40 in) H $\times$ 31 mm (1.22 in) D (Excluding protrusions), 95 g (3.4 oz) (Not including the battery)
Included accessories	CD-R $\times 1$ (Instruction Manual, Logger Utility, Wireless Logger Collector), Measurement Guide $\times 1$ , Caution for Using Radio Waves $\times 1$ , AA alkaline batteries (LR6) $\times 2$

**Other options**

AC ADAPTER Z2003  
100 to 240V AC

MAGNETIC STRAP Z5004

**Measurement sensor**

HUMIDITY SENSOR Z2010  
50 mm (0.16 ft)

HUMIDITY SENSOR Z2011  
1.5 m (4.92 ft)

Sensor guaranteed for 1 year

## Measure load current and leak current easily with clamp sensors

### WIRELESS CLAMP LOGGER LR8513



\*Clamp sensor is sold separately (Sensor guaranteed for 1 year.)

- Measure AC and DC load current and AC leak current
- Choose from many current sensors
- Place inside a distribution panel, close the cover, and monitor measured values from the outside
- Measure power easily—just set the voltage and power factor
- Compact, two-channel model fits where other devices don't
- Download measurement data to a tablet or computer with Bluetooth® wireless technology or capture in real time with the LR8410
- Three-way power (AC adapter, AA alkaline batteries, or external 5 to 13.5 V power supply)
- Store 500,000 data points per channel

Model No. (Order Code) **LR8513** (2 ch, sensor is sold separately)

Note: The LR8513 alone is not capable of making measurements. For the latest information about countries and regions where wireless operation is currently supported, please visit the Hioki website. Bluetooth® is a trademark of Bluetooth SIG, Inc. and licensed for use by HIOKI E.E. CORPORATION.

■ Data can be downloaded using Hioki's tablet and smartphone app (for Android devices). Search for "HIOKI" and download the Wireless Logger Collector!



### Basic specifications (Accuracy guaranteed for 1 year)

Functionality	[Used as standalone product (Data collected manually)] Windows PC or Windows tablet (CD-R with software included) Android smartphone or Android tablet terminal (Software can be downloaded free of charge from Google Play.) *Communication range varies with the performance of the computer or tablet (up to a line-of-sight distance of roughly 30 m) [Used as logging module (Real-time measurement)] Device can be used as an LR8410 logging module to record and display data in real time and to control up to 7 units, Communication distance: 30 m
Number of channels	2ch (common GND)
Measurement items	AC load current, DC load current, AC leak current (using current sensor)
Effective value calculation	Software calculates the true RMS value
Measurement range	500.0 mA to 5000 A AC, 10.00 A to 2000 A DC (By current sensor) *Current and leak current that occur intermittently cannot be measured.
Measurement accuracy	$\pm 0.5\%$ rdg $\pm 5$ dgt (DC, AC 50/60 Hz) *Add the sensor's accuracy when the current sensor is connected
Display items	Measurement value, date, time, number of recorded data, maximum value, minimum value, and average value
Functions	Alarm, Scaling, Recording operation hold function, Erroneous operation prevention, Comment recording function, Power saving function, Authentication function, Free run
Recording	[Capacity] 500,000 data items for each channel [Mode] Instantaneous value, average value, maximum value [Interval] 0.5 to 30 sec, 1 to 60 min, 14 selections
Power source	AC Adapter Z2003 (100 to 240 V AC, 50/60 Hz), AA alkaline batteries (LR6) $\times 2$ , External power 5 to 13.5 V DC (can also be supplied from USB bus power, with a conversion cable)
Continuous operating time ([Capacity] 500,000 data items for each channel) (23°C)	3 months (Recording interval of 1 min, Bluetooth® OFF), 10 days (Recording interval of 1 sec, Bluetooth® ON), 5 days (Recording interval of 0.5 sec, during real-time measurement with the LR8410)
Dimensions and mass	85 mm (3.35 in) W $\times$ 75 mm (2.95 in) H $\times$ 38 mm (1.50 in) D, 130 g (4.6 oz) (excluding the battery)
Included accessories	CD-R $\times 1$ (Instruction Manual, Logger Utility, Wireless Logger Collector), Measurement Guide $\times 1$ , Caution for Using Radio Waves $\times 1$ , AA alkaline batteries (LR6) $\times 2$

For more information about sensors other than those listed below that can be used with the LR8513, see the separate product catalog or Hioki website.

**AC load current**

Approx. 3m (118.1 in)

CLAMP ON SENSOR CT6500 500 A AC

Approx. 3m (118.1 in)

CLAMP ON SENSOR 9669 1000 A AC

**AC leak current**

Approx. 3m (118.1 in)

CLAMP ON LEAK SENSOR 9657-10

**AC load current**

Approx. 3m (118.1 in)

CLAMP ON LEAK SENSOR 9675

**AC/DC load current**

Connected to an AC flexible current sensor

CM7290, CM7291

L9095

CT7044, CT7045, CT7046

Connected to an AC/DC auto-zero current sensor

CT7731, CT7736, CT7742

CM7290, CM7291

L9095

Clamp on Leak Sensor 9657-10, 9675: Rated primary current 5 A\* AC. \*Maximum measurable current when used with the LR8513

**Other options**

AC ADAPTER Z2003  
100 to 240V AC

MAGNETIC STRAP Z5020  
Extra strength



## Perform Pulse Integration of Vehicle Speed or Flow Rate for Equipment Such as Air Conditioners

### WIRELESS PULSE LOGGER LR8512



\*Bundled accessory (L1010)  
Not covered by warranty

- For pulse totalization and measuring logical ON/OFF signals or revolutions
- Compact, two-channel model fits where other devices don't
- Download measurement data to a tablet or computer with Bluetooth® wireless technology or capture in real time with the LR8410
- Three-way power (AC adapter, AA alkaline batteries, or external 5 to 13.5 V power supply)
- Store 500,000 data points per channel

Model No. (Order Code) **LR8512** (2 ch)

For the latest information about countries and regions where wireless operation is currently supported, please visit the HIOKI website.

Bluetooth® is a trademark of Bluetooth SIG, Inc. and licensed for use by HIOKI E.E. CORPORATION.

■ Data can be downloaded using HioKI's tablet and smartphone app (for Android devices).  
Search for "HIOKI" and download the **Wireless Logger Collector!**

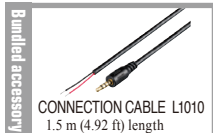

#### ■ Basic specifications (Accuracy guaranteed for 1 year)

Functionality	[Used as standalone product (Data collected manually)] Windows PC or Windows tablet (CD-R with software included) Android smartphone or Android tablet terminal (Software can be downloaded free of charge from Google Play.) *Communication range varies with the performance of the computer or tablet (up to a line-of-sight distance of roughly 30 m) [Used as logging module (Real-time measurement)] Device can be used as an LR8410 logging module to record and display data in real time and to control up to 7 units, Communication distance: 30 m
Number of channels	2ch (common GND)
Measurement items	Integrating (cumulative/Instant), Revolution, Logic (Records a 1/0 for each recording interval)
Supported input format	Non-voltage "a" contact (always-open contact point), open collector, or voltage input (DC 0 to 50 V)
Measurement range	[Totalization] 0 to 1000 M pulse, Max. resolution 1 pulse, [No. of revolutions] 0 to 5000/n [r/s], Max. resolution 1/n [r/s]
Display items	Measurement value, date, time, number of recorded data, maximum value, minimum value, and average value
Functions	Alarm, Scaling, Recording operation hold function, Erroneous operation prevention, Comment recording function, Power saving function, Authentication function
Recording	[Capacity] 500,000 data items for each channel [Mode] Instantaneous value [Interval] 0.1 to 30 sec, 1 to 60 min, 16 selections
Power source	AC Adapter Z2003 (100 to 240 V AC, 50/60 Hz), AA alkaline batteries (LR6) ×2, External power 5 to 13.5 V DC (can also be supplied from USB bus power, with a conversion cable)
Continuous operating time	([Capacity] 500,000 data items for each channel) (23°C) 2 months (Recording interval of 1 min, Bluetooth® OFF), 14 days (Recording interval of 1 sec, Bluetooth® ON), 5 days (Recording interval of 0.1 sec, during real-time measurement with the LR8410)
Dimensions and mass	85 mm (3.35 in) W × 61 mm (2.40 in) H × 31 mm (1.22 in) D, 95 g (3.4 oz) (excluding the battery)
Included accessories	CD-R ×1 (Instruction Manual, Logger Utility, Wireless Logger Collector), Measurement Guide ×1, Caution for Using Radio Waves ×1, AA alkaline batteries (LR6) ×2, Connection cable L1010 ×2

## Compact & Lightweight Heat Flow Logger for Analyzing the Causes of Temperature Change

### HEAT FLOW LOGGER LR8432



- Use a heat flow sensor to measure the movement and volume of heat energy
- Measure of temperature and voltage
- Record measurement data on a USB flash drive for easy transfer to a computer
- Record to reliable Compact Flash cards during long-term measurement applications for increased peace of mind
- Ten isolated analog input channels
- 10 ms sampling and recording across all channels
- Record raw waveforms and post-calculation waveforms at the same time. (Heat transmission coefficient processing)
- Two graduations can be displayed with a double gauge

Model No. (Order Code) **LR8432-20** (10 ch, English model)

Note: The LR8432-20 is not bundled with the Battery Pack 9780. Thermocouples are not provided by HIOKI, and must be purchased from a separate vendor.

Note: Use only HIOKI CF cards, which are manufactured to strict industrial standards, for long-term storage of important data. Correct operation of non-HIOKI CF cards or USB memory sticks is not guaranteed.

#### ■ Basic specifications (Accuracy guaranteed for 1 year)

Specialized functions for heat flow measurement	■ Easy scaling settings: directly enter the sensitivity of the heat flow sensor ■ Calculations: waveform processing function for the analysis of temperature and heat flow (Simple average, moving average, integration, heat transmission coefficient), Integration with numerical calculations
Analog inputs	[No. of channels] 10 isolated analog channels using scanning input method (M3 mm dia. screw terminal block) [Voltage measurement range] ±10 mV to ±60 V, 1-5V, Max. resolution 500 nV [Temperature : thermocouples] -200 °C to 1800 °C (depending on sensor), thermocouples (K, J, E, T, N, R, S, B), Max. resolution 0.1 °C [Humidity] not available [Max. allowable input] 60 V DC [Max. rated voltage between input channels] [Max. rated voltage to earth] 30 AC Vrms, 60 V DC (max. voltage between input channel terminals, and from terminals to chassis ground without damage)
Pulse inputs	[No. of channels] 4 pulse input channels (requires CONNECTION CABLE 9641, all pulse inputs share common ground with the main unit) [Totalized pulses] 0 to 1000M (count) (No-voltage "a" contact, open collector or voltage input), Max. resolution 1 pulse [Rotation count] 0 to 5000/n (r/s), Resolution 1/n (r/s) * n = pulses per rotation (1 to 1,000) [Max. allowable input] 0 to 10 V DC [Max. rated voltage between input channels] [Max. rated voltage to earth] Non-isolated
Recording intervals	10 ms to 1 hour, 19 selections (All input channels are scanned at high speed during every recording interval)
Selectable filters	50 Hz, 60 Hz, or OFF (digital filtering of high frequencies on analog channels)
Memory capacity	Internal storage: 3.5 M-words, External storage: CF card or USB memory stick (only HIOKI CF cards are guaranteed for correct operation)
External interface	USB 2.0 mini-B receptacle ×1; Functions: Control from a PC, Transfers files from the installed CF card to a PC (cannot transfer files from the connected USB memory stick to a PC via USB communication), Data copy between CF card and USB memory stick
Display	4.3-inch WQVGA-TFT color LCD (480 × 272 dots)
Functions	Save data to the CF Card or USB memory stick in real time, Numerical Calculations, etc.
Power supply	AC Adapter Z1005: 100 to 240 VAC (50/60 Hz), 30 VA Max. (including AC adapter), 10 VA Max. (main unit only) Battery Pack 9780: Continuous use 2.5 hours (@25°C/77°F), 3 VA Max. External power source: 10 to 16 V, 10 VA Max. (please contact HIOKI distributor for cable; less than 3 m/9.84 ft cable length)
Dimensions and mass	176 mm (6.93 in) W × 101 mm (3.98 in) H × 41 mm (1.61 in) D, 550 g (19.4 oz) (Battery Pack 9780 not installed)
Included accessories	Measurement Guide ×1, CD-R (Instruction manual PDF, Logger Utility Instruction Manual PDF, Data acquisition application program Logger Utility) ×1, USB cable ×1, AC Adapter Z1005 ×1

Other options: refer to the detailed catalog

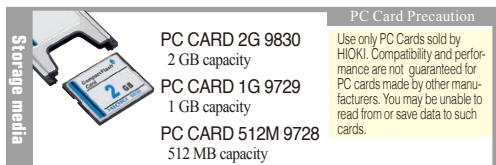

**PC Card Precaution**  
Use only PC Cards sold by HIOKI. Compatibility and performance are not guaranteed for PC cards made by other manufacturers. You may be unable to read from or save data to such cards.

## Logging Multi-point Data Has Never Been So Easy with a Data Wireless Logger

### WIRELESS LOGGING STATION LR8410



LR8410-20 Main unit

LR8510 (Sold separately)



#### Basic specifications (Accuracy guaranteed for 1 year)

No. of measurement channels	Connect up to seven LR8510 series units wirelessly (using Bluetooth® wireless technology) to measure or collect data from up to 105 channels.
Pulse, Digital input	2 pulse input channels or 2 digital input channels (when using the LR8512)
Recording intervals	100 ms <sup>(*)</sup> , 200 ms to 1 hour, 16 selections (All input channels are scanned within each recording interval.) <sup>(*)</sup> Setting not available when the thermocouple burnout detection setting is on
Data storage	Internal memory: 8 M-words, Data storage media: SD memory card or USB memory stick (Only data recorded to a genuine HIOKI SD memory card is guaranteed)
Interface	LAN: 100BASE-TX, USB: USB 2.0 series mini-B receptacle x1
Display device	5.7 inch TFT color liquid crystal display (640 × 480 pixel)
Functions	Save waveform data in real time to the SD memory card or USB memory stick, Numerical value calculations, Waveform calculations, 4ch alarm output (not isolated, common ground), and others
Power supply	[AC adapter] Using the AC adapter Z1008 (100 to 240 V AC, 50/60 Hz), 45 VA Max. (including AC adapter), 15 VA Max. (exclusive of AC adapter) [Internal battery] Using the Battery Pack Z1007 (optional accessory), 3 hours of continuous use (at 23 °C reference data), 7 VA Max. [External power] 10 to 28 V DC, 15 VA Max. (Please contact your HIOKI distributor for connection cord)
Dimensions and mass	230 mm (9.06 in) W × 125 mm (4.92 in) H × 36 mm (1.42 in) D, 700 g (24.7 oz) (excluding Battery Pack)
Included accessories	Instruction manual x1, Measurement guide x1, SD Memory Card (2GB) Z4001 x1, CD-R (data collection software "Logger Utility") x1, USB cable x1, AC Adapter Z1008 x1

#### LR8510 Basic specifications

Measurement parameters	[No. of channels] 15 analog channels; isolated scanning method input (2 terminals: M3 screw type) [Voltage] ±10 mV to ±100 V, 1-5 V f.s., max. 500 nV resolution [Temperature: Thermocouples] -200 °C to 2000 °C (depends on sensor), Thermocouples (K, J, T, or other), max. 0.01 °C resolution Not available for [Pt 100, JPt 100 sensor] [Resistance] [Humidity] [Max. rated voltage between isolated input channels] 300 V DC [Max. allowable input] ±100 V DC [Max. rated voltage from isolated terminals to ground] 300 V AC, DC
Power supply	[AC adapter] Using the AC adapter Z1008 (100 to 240 V AC, 50/60 Hz), 23 VA Max. (including AC adapter), 7 VA Max. (exclusive of AC adapter) [Internal battery] Using the Battery Pack Z1007 (optional accessory), 24 hours of continuous use (at 100 ms recording interval, 23 °C reference data), 0.4 VA Max. [External power] 10 to 28 V DC, 7 VA Max.

#### LR8511 Basic specifications

Measurement parameters	[No. of channels] 15 analog channels; isolated scanning method input (4 terminals: push-button type) [Voltage] ±10 mV to ±100 V, 1-5 V f.s., max. 500 nV resolution [Temperature: Thermocouples] -200 °C to 2000 °C (depends on sensor), Thermocouples (K, J, T, or other), max. 0.01 °C resolution [Temperature: Pt 100, JPt 100 sensor] -200 °C to 800 °C, max. 0.01 °C resolution (not isolated between channels) [Resistance] 0 Ω to 200 Ω f.s., max. 0.5 mΩ resolution (not isolated between channels) [Humidity] 5.0 to 95.0 % rh (use with optional sensor), 0.1 % rh resolution (not isolated between channels) [Max. rated voltage between isolated input channels] 300 V DC [Max. allowable input] ±100 V DC [Max. rated voltage from isolated terminals to ground] 300 V AC, DC
Power supply	Same as the LR8510

- Capture logging data using Bluetooth® wireless technology. Install logging modules in hard-to-reach locations (over line-of-sight distances of up to 30 meters \*1)
- (\*1) The presence of obstructions may shorten this range. In addition, radio wave intensities, which are indicated with the antenna-like indicators, vary depending on units even while these units are operating in the same environment.
- Measurement units have built-in buffer memory so that measurement data can be saved if communication is temporarily disrupted.
- Choose an input unit based on the parameters you wish to measure (15-channel and 2-channel units are available)
- Easily add up to 7 input units wirelessly to keep your environment free of tangled wires (for a total of up to 105 channels when using 15-channel units)
- 100 msec simultaneous sampling across all channels using rapid scanning method
- Quick Set guide makes configuration a breeze
- Can receive data from LR8410 Link compatible products (Ver. 1.40 or later)

Model No. (Order Code) **LR8410-20** (English model, main unit only)

The LR8410-20 alone is not capable of making measurements. One or more input modules are necessary to measure. The main unit and input modules are not bundled with the Battery Pack Z1007. Thermocouples are not provided by HIOKI, and must be purchased from a separate vendor.

Note: Use only HIOKI SD Memory card, which is manufactured to strict industrial standards, for long-term storage of important data. Correct operation of non-HIOKI SD cards or USB memory sticks are not guaranteed.  
\*Models LR8512 to LR8515 may only be used in countries in which they have been certified.  
These products emit radio waves. Use of radio waves is subject to licensing requirements in certain countries. Use in countries or regions other than those listed above may constitute a violation of law, exposing the operator to legal penalties.  
\*The Bluetooth® word mark and logos are registered trademarks owned by Bluetooth SIG, Inc. and any use of such marks by HIOKI E.E. CORPORATION is under license.  
\*For the latest information about countries and regions where wireless operation is currently supported, please visit the HioKI website.

**Input modules**

**WIRELESS VOLTAGE/TEMP UNIT LR8510**  
2 terminals M-3 mm screw type, 15 channels, Voltage, temperature with thermocouple

**WIRELESS UNIVERSAL UNIT LR8511**  
4 terminals push-button type, 15 channels, Voltage, temperature with thermocouple, platinum resistance temperature sensor, humidity, or resistance measurement

**WIRELESS PULSE LOGGER LR8512**  
2ch, pulse/No. of revolutions/logic measurement, for the LR8410

**WIRELESS CLAMP LOGGER LR8513**  
2ch, AC and DC load current/AC leak current measurement

**WIRELESS HUMIDITY LOGGER LR8514**  
2 ch temperature/ 2 ch humidity recording

**WIRELESS VOLTAGE/TEMP LOGGER LR8515**  
2 ch voltage / thermocouple (K, T) recording

**WIRELESS FUNGAL LOGGER LR8520**  
Record fungal index, growth prediction, temperature and humidity

**Storage media**

**SD MEMORY CARD 2GB Z4001**  
2 GB capacity

**SD MEMORY CARD Z4003**  
8 GB capacity

**USB DRIVE Z4006**  
16 GB capacity

\*Z4001 is bundled with the LR8410

**SD Card Precaution**  
Use only the SD Card Z4001 sold by HIOKI. Compatibility and performance are not guaranteed for SD cards made by other manufacturers. You may be unable to read from or save data to such cards.

**Input options**

**HUMIDITY SENSOR Z2000**  
3 m (9.84 ft) length

**Power supply**

**BATTERY PACK Z1007**  
Li-ion, charges while installed

**AC ADAPTER Z1008**  
100 to 240V AC

**Carrying cases and stands**

**CARRYING CASE C1007**  
Holds one LR8410s and four measurement units

**FIXED STAND Z1009**  
For wall hanging and slanted bench mounting

**PC peripherals**

**GENNECT One SF4000**  
Application for Windows

**LAN CABLE 9642**  
Straight Ethernet cable, supplied with straight to cross conversion adapter, 5 m (16.4 ft) length

## 1ms Sampling Portable Logger Expandable to 120 Channels with Your Choice of Plug-in Units

### MEMORY HiLOGGER LR8450



Measurement units (Sold separately)

LR8450 Main unit installed with U8552+U8550



- Expandable to 120 ch with wired/plug-in units
- Record voltage output from pressure and other sensors with 1ms sampling speed
- Directly connect strain gauge and measure signals in as fast as 1ms intervals
- Significantly reduced effects from noise let you safely measure in high voltage and high frequency areas such as around inverter motors

Model No. (Order Code) **LR8450** (Standard model, main unit only)

Note) Measurement is not possible with the LR8450 only. One or more plug-in units are required (sold separately).

#### ■ Basic specifications (Accuracy guaranteed for 1 year)

Max. number of connectable modules	4 plug-in input modules
Connectable modules (Plug-in modules)	U8550, U8551, U8552, U8553, U8554, U8555
No. of measurement channels	Up to 120 ch with plug-in input modules (U8555 can input up to 500 channels per unit)
Pulse/logic input	[Number of ch] 8 ch (common GND, non-isolated, exclusive setting for pulse/logic input for individual channels) [Adaptive input format] Non-voltage contact, open collector, or voltage input [Count] 0 to 1000 M pulse, 1 pulse resolution [Rotational speed] 0 to 5000/n (r/s), 1/n (r/s) resolution, 0 to 300,000/n (r/min.), 1/n (r/min.) resolution, n: Number of pulses per rotation (1 to 1000) [Logic input] Records 1 or 0 for each recording interval
Recording intervals	1 ms *, 2 ms *, 5 ms * (* Can be set only when using 1 ms/S modules), 10 ms to 1 hour, 22 selections (Data refresh interval can be set for each unit)
Data storage	SD Memory Card/USB Drive (user-selectable) (Only storage media sold by HIOKI are guaranteed for operation)
LAN interface	100BASE-TX / 1000BASE-T, DHCP, DNS support, Functions: Data acquisition, condition settings used with the Logger Utility software, configuring settings and controlling recording using communications commands, FTP server / FTP client, HTTP server, Email transmission, NTP client
USB interface	Series A receptacle × 2; USB 2.0 compliant (USB drive, keyboard, or hub) Series mini-B receptacle × 1. Data acquisition, condition settings used with the Logger Utility, configuring settings and controlling recording using communications commands, transferring data from a connected SD Memory Card to a computer
SD card slot	SD standard-compliant slot × 1 (with SD memory card/SDHC memory card support), Guaranteed-operation options: Z4001, Z4003
Display	7 inch TFT color liquid crystal display (WVGA 800 × 480 pixel)
Functions	Save waveform data in real time to the SD memory card or USB drive, numerical value calculations, waveform calculations, 8ch alarm output, voltage output ×2 (5 V /12 V /24 V selectable)
Power supply	[AC adapter] Using the Z1014 (100 V to 240 V AC, 50 Hz/60 Hz), 95 VA Max. (including AC adapter), 28 VA Max. (exclusive of AC adapter) [Battery Pack] Using the Z1007 (accommodates 2 batteries), continuous use 4 hr (reference value for 2 pieces), 20 VA Max. [External power] 10 V to 30 V DC, 28 VA Max. (Please contact your HIOKI distributor for connection cord)
Dimensions and mass	Without any modules: 272 mm (10.71 in) W × 145 mm (5.71 in) H × 43 mm (1.69 in) D (excluding protrusions), 1108 g (39.1 oz) (excluding Battery Pack) With 2 modules: 272 mm (10.71 in) W × 198 mm (7.80 in) H × 63 mm (2.48 in) D (excluding protrusions) With 4 modules: 272 mm (10.71 in) W × 252 mm (9.92 in) H × 63 mm (2.48 in) D (excluding protrusions)
Included accessories	Quick Start Manual ×1, LOGGER Application Disc (Quick Start Manual, Instruction Manual, Logger Utility, Logger Utility Instruction Manual, CAN editor, CAN editor instruction manual, Communication Instruction Manual) ×1, USB Cable ×1, AC Adapter Z1014 ×1

## 1ms Sampling Portable Logger Expandable to 330 Channels with Your Choice of Wireless and Plug-in Units

### MEMORY HiLOGGER LR8450-01 (Wireless LAN model)



Measurement units (Sold separately)

LR8450-01 Main unit installed with U8552+U8550



- Wireless LAN model expandable to 330 ch with wireless and plug-in units
- Record voltage output from pressure and other sensors with 1ms sampling speed
- Directly connect strain gauge and measure signals in as fast as 1ms intervals
- Significantly reduced effects from noise let you safely measure in high voltage and high frequency areas such as around inverter motors
- Avoid wiring issues by minimizing cable length using wireless units
- Monitor data captured remotely on PC with wireless LAN technology

Model No. (Order Code) **LR8450-01** (Wireless LAN equipped model, main unit only)

The LR8450 and LR8450-01 cannot perform measurement on their own. One or more plug-in modules or wireless modules are required (sold separately).

Note) The LR8450-01 and wireless modules emit radio waves. Use of radio waves is subject to licensing requirements in certain countries. Using it in a country or region other than those indicated may violate the law and may result in legal penalties for the operator.

Note) For the latest information about countries and regions where wireless operation is currently supported, please visit the Hioki website.

#### ■ Basic specifications (Accuracy guaranteed for 1 year)

Max. number of connectable modules	4 plug-in input modules + 7 wireless input modules
Connectable modules (Plug-in modules)	U8550, U8551, U8552, U8553, U8554, U8555
Connectable modules (Wireless modules)	LR8530, LR8531, LR8532, LR8533, LR8534, LR8535
No. of measurement channels	Up to 120 ch with plug-in input modules, up to 330 ch with plug-in input modules and wireless input modules (U8555 and LR8535 can input up to 500 channels per unit)
Pulse/logic input	[Number of ch] 8 ch (common GND, non-isolated, exclusive setting for pulse/logic input for individual channels) [Adaptive input format] Non-voltage contact, open collector, or voltage input [Count] 0 to 1000 M pulse, 1 pulse resolution [Rotational speed] 0 to 5000/n (r/s), 1/n (r/s) resolution, 0 to 300,000/n (r/min.), 1/n (r/min.) resolution, n: Number of pulses per rotation (1 to 1000) [Logic input] Records 1 or 0 for each recording interval
Recording intervals	1 ms *, 2 ms *, 5 ms * (* Can be set only when using 1 ms/S modules), 10 ms to 1 hour, 22 selections (Data refresh interval can be set for each unit)
Data storage	SD Memory Card/USB Drive (user-selectable) (Only storage media sold by HIOKI are guaranteed for operation)
LAN interface	100BASE-TX / 1000BASE-T, DHCP, DNS support, Functions: Data acquisition, condition settings used with the Logger Utility software, configuring settings and controlling recording using communications commands, FTP server / FTP client, HTTP server, Email transmission, NTP client
Wireless LAN interface	IEEE 802.11b/g/n Communications range: 30 m, line of sight Encryption function: WPA-PSK/WPA2-PSK, TKIP/AES Usable channels: 1 to 11 Supported modes: Wireless unit connectivity, access point, station Functions: Configuring settings and controlling recording using communications commands, FTP server / client, HTTP server, NTP client
USB interface	Series A receptacle × 2; USB 2.0 compliant (USB drive, keyboard, or hub) Series mini-B receptacle × 1. Data acquisition, condition settings used with the Logger Utility, configuring settings and controlling recording using communications commands, transferring data from a connected SD Memory Card to a computer
SD card slot	SD standard-compliant slot × 1 (with SD memory card/SDHC memory card support), Guaranteed-operation options: Z4001, Z4003
Display	7 inch TFT color liquid crystal display (WVGA 800 × 480 pixel)
Functions	Save waveform data in real time to the SD memory card or USB drive, numerical value calculations, waveform calculations, 8ch alarm output, voltage output ×2 (5 V /12 V /24 V selectable)
Power supply	[AC adapter] Using the Z1014 (100 V to 240 V AC, 50 Hz/60 Hz), 95 VA Max. (including AC adapter), 28 VA Max. (exclusive of AC adapter) [Battery Pack] Using the Z1007 (accommodates 2 batteries), continuous use 4 hr (reference value for 2 pieces), 20 VA Max. [External power] 10 V to 30 V DC, 28 VA Max. (Please contact your HIOKI distributor for connection cord)
Dimensions and mass	Without any modules: 272 mm (10.71 in) W × 145 mm (5.71 in) H × 43 mm (1.69 in) D (excluding protrusions), 1108 g (39.1 oz) (excluding Battery Pack) With 2 modules: 272 mm (10.71 in) W × 198 mm (7.80 in) H × 63 mm (2.48 in) D (excluding protrusions) With 4 modules: 272 mm (10.71 in) W × 252 mm (9.92 in) H × 63 mm (2.48 in) D (excluding protrusions)
Included accessories	Quick Start Manual ×1, LOGGER Application Disc (Quick Start Manual, Instruction Manual, Logger Utility, Logger Utility Instruction Manual, CAN editor, CAN editor instruction manual, Communication Instruction Manual) ×1, USB Cable ×1, AC Adapter Z1014 ×1, Precautions Concerning Use of Equipment that Emits Radio Waves (LR8450-01 only) ×1

## Common options for LR8450 and LR8450-01

Plug-in modules



**VOLTAGE/TEMP UNIT U8550**

Voltage, Temperature (thermocouples), Humidity, 15 ch, 10 ms sampling



**UNIVERSAL UNIT U8551**

Voltage, Temperature (thermocouples), Humidity, Pt100/1000, JPt100, Resistance, 15 ch, 10 ms sampling



**VOLTAGE/TEMP UNIT U8552**

Voltage, temperature (thermocouples), humidity, 30 ch, 20 ms sampling, 10 ms when the number of channels used is 15 or less



**HIGH SPEED VOLTAGE UNIT U8553**

Voltage, 5 ch, 1 ms sampling



**STRAIN UNIT U8554**

Strain, voltage, strain gauge transducer, 5 ch, 1 ms sampling



**CAN UNIT U8555**

CAN/CAN FD input and output switchable, 2 ports, max. sampling 10 ms (up to 50 ch), Up to 500 ch (at 100 ms)

Wireless modules



**WIRELESS VOLTAGE/TEMP UNIT LR8530**

Voltage and temperature (thermocouples), 15 ch, 10 ms sampling



**WIRELESS UNIVERSAL UNIT LR8531**

Voltage, Temperature (thermocouples), Humidity, Pt100/1000, JPt100, Resistance, 15 ch, 10 ms sampling



**WIRELESS VOLTAGE/TEMP UNIT LR8532**

Voltage and temperature (thermocouples), 30 ch, 20 ms sampling, 10 ms sampling when the number of channels used is 15 or less



**WIRELESS HIGH SPEED VOLTAGE UNIT LR8533**

Voltage, 5 ch, 1 ms sampling



**WIRELESS STRAIN UNIT LR8534**

Strain, voltage, strain gauge transducer, 5 ch, 1 ms sampling



**WIRELESS CAN UNIT LR8535**

CAN/CAN FD input and output switchable, 2 ports, max. sampling 10 ms (up to 50 ch), Up to 500 ch (at 100 ms)

Input options



**HUMIDITY SENSOR Z2000**  
3 m (9.84 ft) length



**Thermocouple**  
\*For reference only. Please purchase locally.

For CAN modules



**NON-CONTACT CAN SENSOR SP7001-95**  
Supports CAN FD/CAN signals, SP7001, SP9250, SP7150 set



**CAN CABLE 9713-01**  
For U8555/LR8535, unprocessed on one end, 1.8 m (5.91 ft) length

For wireless modules



Bundled with the Wireless modules

**WIRELESS LAN ADAPTER Z3230**  
Connected to a wireless unit

Power supply



**BATTERY PACK Z1007**  
For LR8410, LR8410-01 and wireless modules



**AC ADAPTER Z1014**  
For LR8410 and LR8410-01, 100 to 240V AC



**AC ADAPTER Z1008**  
For wireless modules, 100 to 240V AC

\*Z1014 is bundled with the LR8450, LR8450-01 \*Z1008 is bundled with the wireless modules

Carrying cases/stands



**CARRYING CASE C1012**  
Holds the main unit, 4 plug-in modules and 7 wireless modules



**FIXED STAND Z5040**  
For installing logger on wall

PC peripherals

LOGGER UTILITY and CAN EDITOR are bundled software

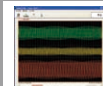

**LOGGER UTILITY SF1000**  
Control the measurement of loggers and collect data in real-time



**CAN EDITOR SF1002**  
Software for CAN unit settings



**LAN CABLE 9642**  
Straight Ethernet cable, supplied with straight to cross conversion adapter, 5 m (16.41 ft) length

Storage media

**SD MEMORY CARD Z4001**  
2 GB capacity



**SD MEMORY CARD Z4003**  
8 GB capacity



**USB DRIVE Z4006**  
16 GB, Long-life, High-reliability SLC Flash Memory



**Precaution on purchasing memory device**

Use only the memory device sold by HIOKI. Compatibility and performance are not guaranteed for memory device made by other manufacturers. You may be unable to read from or save data to such devices.

## Featuring USB Flash Drive and Improved Accuracy! Your Personal 10-channel Logger

### MEMORY HILOGGER LR8431



USB 2.0

CE

3 year Warranty

- Record measurement data on a USB flash drive for easy transfer to a computer
- Record to reliable Compact Flash cards during long-term measurement applications for increased peace of mind
- Replace storage media during real-time recording
- Improved thermocouple measurement accuracy and reference junction compensation accuracy
- Ten isolated analog input channels
- 10 ms sampling and recording across all channels
- Noise-resistant measurement circuitry for improved readings
- Ultra-compact for convenient portability
- Widescreen, bright LCD gives excellent viewability

Model No. (Order Code) **LR8431-20** (10 ch, English model)

Note: The LR8431-20 is not bundled with the Battery Pack 9780. Thermocouples are not provided by HIOKI, and must be purchased from a separate vendor.  
Note: Use only HIOKI CF cards, which are manufactured to strict industrial standards, for long-term storage of important data. Correct operation of non-HIOKI CF cards or USB memory sticks is not guaranteed.

#### Basic specifications (Accuracy guaranteed for 1 year)

Analog inputs	[No. of channels] 10 isolated analog channels using scanning input method (M3 mm dia. screw terminal block) [Voltage measurement range] ±10 mV to ±60 V, 1-5V, Max. resolution 500 nV [Temperature : thermocouples] -200 °C to 1800 °C (depending on sensor), thermocouples (K, J, E, T, N, R, S, B), Max. resolution 0.1 °C [Humidity] not available [Max. allowable input] 60 V DC [Max. rated voltage between input channels] [Max. rated voltage to earth] 30 AC Vrms, 60 V DC (max. voltage between input channel terminals, and from terminals to chassis ground without damage)
Pulse inputs	[No. of channels] 4 pulse input channels (requires CONNECTION CABLE 9641, all pulse inputs share common ground with the main unit) [Totalized pulses] 0 to 1000M (count) (No-voltage 'a' contact, open collector or voltage input), Max. resolution 1 pulse [Rotation count] 0 to 5000/n (r/s), Resolution 1/n (r/s) * n = pulses per rotation (1 to 1,000) [Max. allowable input] 0 to 10 V DC [Max. rated voltage between input channels] [Max. rated voltage to earth] Non-isolated
Recording intervals	10 ms to 1 hour, 19 selections (All input channels are scanned at high speed during every recording interval)
Selectable filters	50 Hz, 60 Hz, or OFF (digital filtering of high frequencies on analog channels)
Memory capacity	Internal storage: 3.5 M-words, External storage: CF card or USB memory stick (only HIOKI CF cards are guaranteed for correct operation)
External interface	USB 2.0 mini-B receptacle ×1; Functions: Control from a PC, Transfers files from the installed CF card to a PC (cannot transfer files from the connected USB memory stick to a PC via USB communication), Data copy between CF card and USB memory stick
Display	4.3-inch WQVGA-TFT color LCD (480 × 272 dots)
Functions	Save data to the CF card or USB memory stick in real time, Numerical Calculations, etc.
Power supply	AC Adapter Z1005: 100 to 240 VAC (50/60 Hz), 30 VA Max. (including AC adapter), 10 VA Max. (main unit only) Battery Pack 9780: Continuous use 2.5 hours (@25°C/77°F), 3 VA Max. External power source: 10 to 16 V, 10 VA Max. (please contact HIOKI distributor for cable; less than 3 m/9.84 ft cable length)
Dimensions and mass	176 mm (6.93 in) W × 101 mm (3.98 in) H × 41 mm (1.61 in) D, 550 g (19.4 oz) (Battery Pack 9780 not installed)
Included accessories	Measurement Guide ×1, CD-R (Instruction manual PDF, Logger Utility Instruction Manual PDF, Data acquisition application program Logger Utility) ×1, USB cable ×1, AC Adapter Z1005 ×1

Other options: refer to the detailed catalog

<b>BATTERY PACK 9780</b> NiMH, Charges while installed in the main unit	<b>SOFT CASE 9812</b> Includes space for small items, Neoprene rubber	<b>CARRYING CASE 9782</b> Includes compartment for options, Resin coated	<b>CONNECTION CABLE 9641</b> For pulse inputs, 1.5 m (4.92 ft) length	<b>PROTECTION SHEET 9809</b> For LCD protection, pairs of additional sheets
--	--	---	--	--

<b>Storage media</b>	<b>PC CARD 2G 9830</b> 2 GB capacity	<b>PC Card Precaution</b> Use only PC Cards sold by HIOKI. Compatibility and performance are not guaranteed for PC cards made by other manufacturers. You may be unable to read from or save data to such cards.
	<b>PC CARD 1G 9729</b> 1 GB capacity	
	<b>PC CARD 512M 9728</b> 512 MB capacity	

## Fast 10-ms Sampling. Up to 600 Channels of Data Logging

### MEMORY HILOGGER 8423



Example: Connect up 8 measurement modules for a 120-channel system

USB 2.0

LAN

CE

3 year Warranty

- Capture data with 15 to a maximum of 600 channels
- Send data to the PC in real time
- Isolated to sustain up to 600 V between modules and earth
- USB 2.0, LAN 100BASE-TX, store to 1GB PC Card
- Simultaneous fast- and low-speed sampling allows for media storage space efficiency

Model No. (Order Code) **8423** (Main unit only)

Note: 8423 cannot operate alone. You must install one or more optional input modules in the unit. Thermocouples are not provided by HIOKI, and must be purchased from a separate vendor.

#### Basic specifications (Accuracy guaranteed for 1 year)

No. of connectable units	Maximum 8 units (total 120 channels), Bundle 8 Modules together to achieve a 120-channel System, Bundle 5 Systems together to enable a maximum of 600 channels of simultaneous recording
Measurement parameters Model 8948	[No. of channels] 15 analog channels, isolated scanning method input (2 terminals: M3 screw type) [Voltage measurement range] ±150 mV to ±100 V, 1-5V, Max. resolution 5 µV, Max. allowable input: 100 VDC, between channels: 200 VDC, to earth: 600 VAC/DC [Temperature range] -200°C to 2000°C (depend on the sensor), thermocouples (K, J, E, T, N, R, S, B, W), Max. resolution 0.01°C
Measurement parameters Model 8949	[No. of channels] 15 analog channels, isolated scanning method input (4 terminals: push-button type) (not isolated between channels at resistance temperature sensor & humidity sensor) [Voltage measurement range] ±150 mV to ±60 V, 1-5V, Max. resolution 5 µV, Max. allowable input: 60 VDC, between channels: 120 VDC, to earth: 600 VAC/DC [Temperature range] -200°C to 2000°C (depend on the sensor), thermocouples (K, J, E, T, N, R, S, B, W), Max. resolution 0.01°C [Resistance temperature sensor range] -200°C to 800°C, (Pt 100, JPt 100), Max. resolution 0.01°C [Humidity] 5.0 to 95.0% rh, (use with optional sensor 9701), resolution 0.1% rh
Measurement parameters Model 8996	[No. of channels] 15 channels, digital/pulse input (2 terminals: M3 screw type, CH1-5, CH6-10, CH11-15 are common GND, No-voltage 'a' contact, open collector or voltage input) [Totalized pulses] 0 to 1000M pulse, Max. resolution 1 pulse [Rotation count] 0 to 5000/n (r/s), Resolution 1/n (r/s) * n = pulses per rotation (1 to 1,000) [Digital input] Record ON/OFF digital signal per interval [Max. allowable input] 50 VDC, between channels: 33 VACrms or 70 VDC, to earth: 600 VAC/DC, (Upper limit voltage that does not cause damage when applied between CH1-5, CH6-10, CH11-15 each channel and chassis, and between each UNITS)
Recording intervals	10ms to 1hr, 19 ranges (5s to 1hr when combined with humidity measurement), Dual sampling: Recording intervals can be specified for every input module (high-speed and low-speed)
Function	Measurement data are saved to the CF Card in real time, Trigger function, Digital filter (Input unit), Alarm output (use with the Alarm unit 8997), Data acquisition is controlled by the PC data acquisition program, FTP server function, HTTP server function
Interface	LAN: supports 100Base-TX, USB: Ver 2.0, mini-B receptacle, CF card slot
Power supply	Using the AC adapter 9418-15 (100 to 240 V, 50/60 Hz), 55 VA Max. (include AC adapter), 20 VA Max. (main unit only) (when connected with 8 units), External DC Power: 9.6 V to 15.6 VDC, 20 VA Max. (when connected with 8 units) (Please contact HIOKI for connection cord)
Dimensions and mass	67 mm (2.64 in) W × 133 mm (5.24 in) H × 125 mm (4.92 in) D, 600 g (21.2 oz) (main unit 8423 only)
Included accessories	Quick start manual ×1, Instruction manual ×1, AC adapter 9418-15 ×1, USB cable ×1, CD-R (data collection software "Logger Utility") ×1, Connector cover ×1, Ferrite clamp ×1, Connection plate ×1

Other options refer to the detailed catalog

<b>VOLTAGE/TEMP UNIT 8948</b> 15-channels, Voltage, thermocouple input	<b>UNIVERSAL UNIT 8949</b> 15-channels, Voltage, resistance temperature sensor, humidity measurement	<b>DIGITAL/PULSE UNIT 8996</b> 15-channels, ON/OFF logic signal, Totalized pulses (integrated or instantaneous), rotation count	<b>ALARM UNIT 8997</b> 15-channels, Open-collector output	<b>CONNECTION CABLE 9683</b> For synchronization, cable length 1.5 m (4.92 ft)
---	---	--	--	---

<b>Storage media</b>	<b>PC Card Precaution</b> Use only PC Cards sold by HIOKI. Compatibility and performance are not guaranteed for PC cards made by other manufacturers. You may be unable to read from or save data to such cards.	<b>* PC CARD 2G 9830 - cannot use with the 8423</b>
	<b>PC CARD 1G 9729</b> (1 GB capacity)	
	<b>PC CARD 512M 9728</b> (512 MB capacity)	

## Transfer Data from a LR5000 Series Data Logger to PC

**COMMUNICATION ADAPTER LR5091**  
**DATA COLLECTOR LR5092**

Recorders  
Data Loggers



LR5091  
(USB cable is bundled)

LR5092  
(USB cable is bundled)

- Bring the data logger LR5000 series back from the field and transfer data to a PC
- Save data from data loggers in the built-in memory or on an SD card (LR5092-20)
- Send settings from a PC to a data logger
- Use the included software to easily graph and print data
- Use the included software to calculate maximum, minimum, and average values and more between cursors

Model No. (Order Code) **LR5091** (For the LR5000 series)  
**LR5092-20** (For the LR5000 series)

Note: Communication Adapter LR5091 or Data Collector LR5092-20 is necessary to collect data from the LR5000 series Logger and transfer data to a PC.

<How to use> Transferring data from the LR5000 series Logger to a PC

- (1) Place the LR5000 series Logger on the Communications Adapter LR5091 and connect the adapter to the computer with a USB cable.
- (2) Take the Data Collector LR5092 to the location where the Data Mini was placed and capture the data via optical communications. Transfer data from the device to a PC via the SD card or connect with a USB cable.

For the LR5092

**SD Card Precaution**  
Use only SD Cards sold by HIOKI. Compatibility and performance are not guaranteed for SD cards made by other manufacturers. You may be unable to read from or save data to such cards.

**SD MEMORY CARD**  
2GB Z4001  
2GB capacity

**LR5000 Utility**  
(PC communication software; included)

Table and graph display, data analysis, data processing, transmission of settings to data loggers, print functionality, etc.  
\*The utility can also display data collected using the Data Logger 3630 series

### Basic specifications

	LR5091	LR5092-20
Function	Transfer data from a data logger to a PC Send settings and the time from a PC to a data logger.	Send data from a data logger to the internal memory or an SD card, then display a graph. Send settings and the time from the internal memory or SD card to a data logger. Send data from a data logger to a PC. Send settings and the time from a PC to a data logger.
Communication method	Between data loggers: Infrared communication With PC: USB 2.0	Between data loggers: Infrared communication With PC: USB 2.0
Display	N/A	Data logger setting conditions Collected data (as list, graph, values, etc.)
Internal memory capacity of data	N/A	60,000 data elements ×16ch (instantaneous value mode) 15,000 data elements ×16ch (statistical value mode) Data logger settings (max. 1 set)
Removable storage media	N/A	SD Memory card Save data and max. 16 items configuration
Power supply	USB bus power	DC 3 V (LR6 (AA) Alkaline battery ×2) USB bus power (12 hours or 500 times of data collection)
Dimensions and mass	83 mm (3.27 in)W × 61 mm (2.40 in)H × 19 mm (0.75 in)D, 43 g (1.5 oz)	91 mm (3.58 in)W × 141 mm (5.55 in)H × 31 mm (1.22 in)D, 215 g (7.6 oz) (excluding batteries and SD memory card)
Included accessories	USB cable (1m) ×1, CD (Application software "LR5000 Utility") ×1	Instruction manual ×1, Operation guide ×1, LR6 (AA) Alkaline battery ×2, USB cable (1m) ×1, CD (Application software "LR5000 Utility") ×1

### LR5000 Utility Specifications

Operating environment	OS: Windows 7 (32/64bit, .NET Framework 2.0 or more), Vista (32bit, SP1 or more), XP (SP2 or more) *USB interface (when using the Communication Base 3910/3911, a COM port is required)
Function	<ul style="list-style-type: none"> <li>• Settings: Communicates via infrared light with LR5000 series loggers to send and receive settings.</li> <li>• Graph function: Displays graphs of up to 16 channels, displays statistical data, etc.</li> <li>• Print function: Print graphs, Print statistical data.</li> <li>• Export function (data CSV output, paste into Excel)</li> <li>• Import function (loads text files from the Clamp On Power HiTester 3169-20/-21 [only demand parameter with a recording interval of at least 1 sec.])</li> <li>• Processing of data: Scaling, Power calculation, Energy cost calculation, Operating ratio calculation, Integration, Dew point temperature, Calculate between channels</li> </ul>

## Easily Record Load Current of 50Hz/60Hz Lines and Leak Current

### CLAMP LOGGER LR5051



\*Clamp sensor is sold separately  
(Sensor warranted for one year)

- Easily mount the light-weight, pocket-sized loggers in tight spaces
- Easy-to-see dual display
- Transfer data to PC even during recording
- Replace batteries while recording (30 second limit)
- 3 times the memory capacity compared to predecessor (Record 60,000 data per channel)
- Record without missing fluctuations in STAT mode
- Measurement data is preserved even after the battery dies
- Worry-free backup preserves recorded data even if a new measurement is started by mistake

Model No. (Order Code) **LR5051** (2ch, clamp sensor is sold separately)

Note: The Clamp Logger LR5051 may be affected by high-frequency noise while measuring leak current. Please contact Hioki for more information if you plan to use the instrument in an environment where it would be subject to the effects of high-frequency noise.

Customers using the previous Model 3636-20 Clamp Logger should note that the LR5051 can only record 15,000 points of average data, vs. 32,000 data points available in the 3636-20.

Note: Communication Adapter LR5091 or Data Collector LR5092-20 is necessary to collect data from the LR5000 series Logger and transfer data to a PC.

For data acquisition to PC

**Options**

**COMMUNICATION ADAPTER LR5091**  
Dock logger and transfer data via optical communication

**DATA COLLECTOR LR5092-20**  
Dock logger or transfer data to internal memory/SD memory card

**For fitting**

**MAGNETIC STRAP Z5020**  
Extra strength

### Basic specifications (Accuracy guaranteed for 1 year)

Measurement items	AC Current 2 channels (used with the optional current sensor; load current 2ch, leak current 2ch, or load/leak each 1ch) Caution: Current and leak current that occur intermittently cannot be measured.
Measurement range	500.0 mA to 1000 A AC rms, 5 range (depends on current sensor in use)
Basic accuracy	±2.0% rdg ±0.13% f.s. (main unit + current sensor accuracy, at 500.0 A range, 50/60 Hz) Note: Basic accuracy is typical value, only main unit accuracy: ±0.5% rdg ±5 dgt, must added clamp sensor accuracy, refer to the detailed catalog
Storage capacity	Instantaneous value mode: 60,000 data/ch, Statistical value mode: 15,000 data/ch
Recording interval	1 to 30 sec., 1 to 60 min., 15 selections
Recording modes	Instantaneous recording: at every recording interval Statistical value recording: Measure at one second intervals, and record the instantaneous, maximum, minimum, and average values within every recording interval
Recording methods	One-time recording: Stop recording when the memory capacity is full Endless recording: Continue recording even when the memory capacity is full (old data is overwritten) Start: Logger button operation or scheduled time Stop: Logger button operation or scheduled time, or auto-stop when the memory capacity is full (at one-time recording)
Other functions	Always backs up last recorded data; backs up recorded data and setting conditions when battery power is low; guarantees approx. 30 sec. of recording operation and clock while battery is replaced
Waterproof and dust-proof	N/A
Interfaces	Infrared optical communications with LR5091, LR5092-20
Power supply	LR6 (AA) Alkaline battery ×2, Battery life: Approx. 1 year (Instantaneous recording, with 1-minute interval and auto power saving, at 20 °C), Approx. 1 month (Instantaneous recording, with 1-second interval at 20 °C)
Dimensions and mass	79 mm (3.11 in)W × 70 mm (2.76 in)H × 37 mm (1.46 in)D, 165 g (5.8 oz)
Included accessories	LR6 (AA) Alkaline battery (built-in internal) ×2, Instruction manual ×1, Operation guide ×1

Clamp on Leak Sensor 9657-10, 9675: Rated primary current 5 A\* AC \*Maximum measurable current when used with the LR5051.

**Current sensors**

**AC load current**  
Approx. 3m (118.1 in)  
CLAMP ON SENSOR CT6500 500 A AC

**AC load current**  
Approx. 3m (118.1 in)  
CLAMP ON SENSOR 9669 1000 A AC

**AC load current**  
Not CE marked  
CLAMP ON SENSOR 9695-02  
50 A AC, Cable 9219 required

**AC leak current**  
Insulated conductor  
Approx. 3m (118.1 in)  
CLAMP ON LEAK SENSOR 9657-10  
Rated primary current: \*5 AAC

**AC leak current**  
Insulated conductor  
Approx. 3m (118.1 in)  
CLAMP ON LEAK SENSOR 9675  
Rated primary current: \*5 AAC

**CONNECTION CABLE 9219**  
Connect with the 9695-02/-03, Output BNC terminal, 3 m (9.84 ft) cord length

## Record Instrumentation Signals and Measure Analog Output from Sensors and other Devices

### VOLTAGE LOGGER (50mV) LR5041, (5V) LR5042, (50V) LR5043



\*Bundled accessory (LR9802)  
Not covered by warranty

IP54  
(splash-proof construction)

- Easily mount the light-weight , pocket-sized loggers in tight spaces
- Easy-to-see dual display
- Transfer data to PC even during recording
- Replace batteries while recording (30 second limit)
- 3 times the memory capacity than predecessor (Record 60,000 data per channel)
- Record without missing fluctuations in STAT mode
- Measurement data is preserved even after the battery dies
- Worry-free backup preserves recorded data even if a new measurement is started by mistake

#### Basic specifications (Accuracy guaranteed for 1 year)

	LR5041	LR5042	LR5043
Measurement items	DC voltage 1ch	DC voltage 1ch	DC voltage 1ch
Measurement range	-50.00 to 50.00 mV	-5.000 to 5.000 V	-50.00 to 50.00 V
Accuracy	±0.5 %rdg ±5 dgt		
Storage capacity	Instantaneous value mode: 60,000 data, Statistical value mode: 15,000 data		
Recording interval	1 to 30 sec., 1 to 60 min., 15 selections		
Recording modes	Instantaneous recording: at every recording interval Statistical value recording: Measure at one second intervals, and record the instantaneous, maximum, minimum, and average values within every recording interval		
Recording methods	One-time recording: Stop recording when the memory capacity is full Endless recording: Continue recording even when the memory capacity is full (old data is overwritten) Start: Logger button operation or scheduled time Stop: Logger button operation or scheduled time, or auto-stop when the memory capacity is full (at one-time recording)		
Other functions	Pre-heat function (requires external power supply during use of function), Always backs up last recorded data; backs up recorded data and setting conditions when battery power is low; guarantees approx. 30 sec. of recording operation and clock while battery is replaced		
Waterproof and dust-proof	IP54 (EN60529) (with connection cable connected, but not including cable tip)		
Interfaces	Infrared optical communications with LR5091, LR5092-20		
Power supply	LR6 (AA) Alkaline battery ×1, Battery life: Approx. 2 years (Instantaneous recording, with 1-minute interval and auto power saving, at 20 °C), Approx. 2 months (Instantaneous recording, with 1-second interval at 20 °C)		
Dimensions and mass	79 mm (3.11 in)W × 57 mm (2.246 in)H × 28 mm (1.10 in)D, 105 g (3.7 oz)		
Included accessories	LR6 (AA) Alkaline battery (built-in internal) ×1, Connection cable LR9802 ×1, Instruction manual ×1, Operation guide ×1, Kickstand ×1		

Model No. (Order Code)	<b>LR5041</b>	(±50mV DC)
	<b>LR5042</b>	(±5V DC)
	<b>LR5043</b>	(±50V DC)

Note: Communication Adapter LR5091 or Data Collector LR5092-20 is necessary to collect data from the LR5000 series Logger and transfer data to a PC.

Options

For data acquisition to PC

COMMUNICATION ADAPTER LR5091  
Dock logger and transfer data via optical communication

For fitting

MAGNETIC STRAP Z5004

WALL-MOUNTED HOLDER LR9901  
Not compatible with Model LR5051

Bundled accessory

CONNECTION CABLE LR9802  
Tips 4 wires, 1 m (3.28 ft) length

## For 4-20 mA Instrumentation Measurement

### INSTRUMENTATION LOGGER LR5031



\*Bundled accessory (LR9801)  
Not covered by warranty

IP54  
(splash-proof construction)

- 4 - 20 mA DC measurement only
- Easily mount the light-weight , pocket-sized loggers in tight spaces
- Easy-to-see dual display
- Transfer data to PC even during recording
- Replace batteries while recording (30 second limit)
- 3 times the memory capacity than predecessor (Record 60,000 data per channel)
- Measurement data is preserved even after the battery dies
- Worry-free backup preserves recorded data even if a new measurement is started by mistake

#### Basic specifications (Accuracy guaranteed for 1 year)

Measurement items	DC current (1 ch), for Instrumentation
Measurement range	-30.00 to 30.00 mA
Accuracy	±0.5 %rdg ±5 dgt
Storage capacity	Instantaneous value mode: 60,000 data, Statistical value mode: 15,000 data
Recording interval	1 to 30 sec., 1 to 60 min., 15 selections
Recording modes	Instantaneous recording: at every recording interval Statistical value recording: Measure at one second intervals, and record the instantaneous, maximum, minimum, and average values within every recording interval
Recording methods	One-time recording: Stop recording when the memory capacity is full Endless recording: Continue recording even when the memory capacity is full (old data is overwritten) Start: Logger button operation or scheduled time Stop: Logger button operation or scheduled time, or auto-stop when the memory capacity is full (at one-time recording)
Other functions	Always backs up last recorded data; backs up recorded data and setting conditions when battery power is low; guarantees approx. 30 sec. of recording operation and clock while battery is replaced
Waterproof and dust-proof	IP54 (EN60529) (with connection cable connected, but not including cable tip)
Interfaces	Infrared optical communications with LR5091, LR5092-20
Power supply	LR6 (AA) Alkaline battery ×1, Battery life: Approx. 2 years (Instantaneous recording, with 1-minute interval and auto power saving, at 20 °C), Approx. 2 months (Instantaneous recording, with 1-second interval at 20 °C)
Dimensions and mass	79 mm (3.11 in)W × 57 mm (2.246 in)H × 28 mm (1.10 in)D, 105 g (3.7 oz)
Included accessories	LR6 (AA) Alkaline battery (built-in internal) ×1, Connection cable LR9801 ×1, Instruction manual ×1, Operation guide ×1, Kickstand ×1

Model No. (Order Code)	<b>LR5031</b>	(mA DC, 1ch)
------------------------	---------------	--------------

Note: Communication Adapter LR5091 or Data Collector LR5092-20 is necessary to collect data from the LR5000 series Logger and transfer data to a PC.

Options

For data acquisition to PC

COMMUNICATION ADAPTER LR5091  
Dock logger and transfer data via optical communication

For fitting

MAGNETIC STRAP Z5004

WALL-MOUNTED HOLDER LR9901  
Not compatible with Model LR5051

Bundled accessory

CONNECTION CABLE LR9801  
Tips 2 wires, 1 m (3.28 ft) length

## Measure Temperature with External Sensor

### TEMPERATURE LOGGER LR5011



\*Optional sensor (LR9604)  
Not covered by warranty

IP54  
(splash-proof construction)

- Easily mount the light-weight , pocket-sized loggers in tight spaces
- Easy-to-see dual display
- Transfer data to PC even during recording
- Replace batteries while recording (30 second limit)
- 3 times the memory capacity than predecessor (Record 60,000 data per channel)
- Record without missing fluctuations in STAT mode
- Measurement data is preserved even after the battery dies
- Worry-free backup preserves recorded data even if a new measurement is started by mistake

Model No. (Order Code) **LR5011** (Temperature 1ch)

Note: Communication Adapter LR5091 or Data Collector LR5092-20 is necessary to collect data from the LR5000 series Logger and transfer data to a PC.

#### Basic specifications (Accuracy guaranteed for 1 year)

Measurement items	Temperature 1ch (with optional sensor)
Measurement range	-40.0 °C to 180.0 °C *Depends on measurement range of sensor
Basic accuracy	±0.5 °C (main unit + sensor accuracy, at 0.0 to 35.0 °C) Note: Basic accuracy is typical value, refer to the detailed catalog
Storage capacity	Instantaneous value mode: 60,000 data, Statistical value mode: 15,000 data
Recording interval	1 to 30 sec., 1 to 60 min., 15 selections
Recording modes	Instantaneous recording: at every recording interval Statistical value recording: Measure at one second intervals, and record the instantaneous, maximum, minimum, and average values within every recording interval
Recording methods	One-time recording: Stop recording when the memory capacity is full Endless recording: Continue recording even when the memory capacity is full (old data is overwritten) Start: Logger button operation or scheduled time Stop: Logger button operation or scheduled time, or auto-stop when the memory capacity is full (at one-time recording)
Other functions	Always backs up last recorded data; backs up recorded data and setting conditions when battery power is low; guarantees approx. 30 sec. of recording operation and clock while battery is replaced
Waterproof and dust-proof	IP54 (EN60529) (with sensor connected, but not including sensor tip)
Interfaces	Infrared optical communications with LR5091, LR5092-20
Power supply	LR6 (AA) Alkaline battery ×1, Battery life: Approx. 2 years (Instantaneous recording, with 1-minute interval and auto power saving, at 20 °C), Approx. 2 months (Instantaneous recording, with 1-second interval at 20 °C)
Dimensions and mass	79 mm (3.11 in)W × 57 mm (2.246 in)H × 28 mm (1.10 in)D, 105 g (3.7 oz)
Included accessories	LR6 (AA) Alkaline battery (built-in internal) ×1, Instruction manual ×1, Operation guide ×1, Kickstand ×1

For data acquisition to PC



For fixing



Optional sensors

(Molded plastic type) Temperature range: -40 to 180 °C (-40 to 356 °F) Response time: 100 sec (90% response time) Sensor head size: φ6 × 28 mm (0.24 in × 1.10 in)	(Lug type) Temperature range: -30 to 180 °C (-22 to 356 °F) Response time: 45 sec (90% response time) Outer diameter: φ7 mm (0.26 in) Inner diameter: φ3.2 mm (0.13 in)	(Sheathed type) Temperature range: -40 to 120 °C (-40 to 248 °F) Response time: 90 sec (90% response time) Sensor head size: φ4 × 180 mm (0.16 in × 7.09 in)
LR9601 1 m (3.28 ft) length LR9602 5 m (16.41 ft) LR9603 10 m (32.81 ft) LR9604 45 mm (1.77 in)	LR9611 1 m (3.28 ft) length LR9612 5 m (16.41 ft) LR9613 10 m (32.81 ft)	LR9621 1 m (3.28 ft) length
(Needle type) Temperature range: -40 to 120 °C (-40 to 248 °F) Response time: 20 sec (90% response time) Sensor head size: φ1.3 × 25 mm (0.05 in × 0.98 in)		
LR9631 1 m (3.28 ft) length		

## Record Temperature and Humidity Simultaneously

### HUMIDITY LOGGER LR5001



\*Bundled sensor (LR9504)  
Not covered by warranty

IP54  
(splash-proof construction)

- Easily mount the light-weight , pocket-sized loggers in tight spaces
- Easy-to-see dual display
- Transfer data to PC even during recording
- Replace batteries while recording (30 second limit)  
Note: Recording is interrupted during battery replacement if the battery is very weak. After batteries are replaced, recording resumes automatically. Previously recorded data is not lost during battery replacement.
- 7 times the memory capacity than predecessor (Record 60,000 data per channel)
- Record without missing fluctuations in STAT mode
- Measurement data is preserved even after the battery dies
- Worry-free backup preserves recorded data even if a new measurement is started by mistake

Model No. (Order Code) **LR5001** (Temperature / Humidity each 1ch)

Note: Communication Adapter LR5091 or Data Collector LR5092-20 is necessary to collect data from the LR5000 series Logger and transfer data to a PC.

#### Basic specifications (Accuracy guaranteed for 1 year)

Measurement items	Temperature 1ch and Humidity 1ch (Requires included or optional humidity sensor)
Measurement range	Temperature: -40.0 to 85.0 °C, Humidity: 0 to 100 % rh *at sensor environment
Basic accuracy	[Temperature]: ±0.5 °C (main unit + sensor accuracy, at 0.0 to 35.0 °C) [Humidity]: ±5 % rh (main unit + temperature / humidity sensor LR950x combination, at 20 to 30 °C / 10 to 50 % rh) Note: Basic accuracy is typical value, refer to the detailed catalog
Storage capacity	Instantaneous value mode: 60,000 data/ch, Statistical value mode: 15,000 data/ch
Recording interval	1 to 30 sec., 1 to 60 min., 15 selections
Recording modes	Instantaneous recording: at every recording interval Statistical value recording: Measure at one second intervals, and record the instantaneous, maximum, minimum, and average values within every recording interval
Recording methods	One-time recording: Stop recording when the memory capacity is full Endless recording: Continue recording even when the memory capacity is full (old data is overwritten) Start: Logger button operation or scheduled time Stop: Logger button operation or scheduled time, or auto-stop when the memory capacity is full (at one-time recording)
Other functions	Always backs up last recorded data; backs up recorded data and setting conditions when battery power is low Note: After batteries are replaced within 30 seconds, recording resumes automatically (Recording is interrupted during battery replacement)
Waterproof and dust-proof	IP54 (EN60529) (with sensor connected, but not including sensor tip)
Interfaces	Infrared optical communications with LR5091, LR5092-20
Power supply	LR6 (AA) Alkaline battery ×1, Battery life: Approx. 3 months (Instantaneous recording, with 1-minute interval and auto power saving, at 20 °C), Approx. 20 days (Instantaneous recording, with 1-second interval at 20 °C) (typical data: Approx. 1 year recording with 10-minutes interval)
Dimensions and mass	79 mm (3.11 in)W × 57 mm (2.246 in)H × 28 mm (1.10 in)D, 105 g (3.7 oz)
Included accessories	LR6 (AA) Alkaline battery (built-in internal) ×1, Humidity sensor LR9504 ×1, Instruction manual ×1, Operation guide ×1, Kickstand ×1

For data acquisition to PC



For fixing



Optional sensors

Temperature range: -40 to 85 °C Humidity range: 0 to 100 % rh Response time: 300 seconds (90 % response time) Waterproof: None Sensor size: 13×30 mm (0.51×1.18 in)	LR9501 1 m (3.28 ft) length LR9502 5 m (16.41 ft) LR9503 10 m (32.81 ft)	LR9504 40 mm (1.57 in) length
---	--	-------------------------------



## Choose from 5 Models

A complete product line to fully meet your measurement frequency and applications.



Photo: IM7581

### IMPEDANCE ANALYZER IM7580A

Measurement frequency **1 MHz to 300 MHz**  
 Measurement range L : 0.0531 nH to 0.795 mH  
 C : 0.1061 pF to 1.59 μF  
 (Depending on the measurement frequency)  
 Measurement signal level -40.0 dBm to +7.0 dBm  
 Basic accuracy Z : 0.72% rdg θ: 0.41°

### IMPEDANCE ANALYZER IM7581

Measurement frequency **100 kHz to 300 MHz**  
 Measurement range L : 0.0531 nH to 7.95 mH  
 C : 0.1061 pF to 15.9 μF  
 (Depending on the measurement frequency)  
 Measurement signal level -40.0 dBm to +7.0 dBm  
 Basic accuracy Z : 0.72% rdg θ: 0.41°

### IMPEDANCE ANALYZER IM7583

Measurement frequency **1 MHz to 600 MHz**  
 Measurement range L : 0.0265 nH to 0.795 mH  
 C : 0.0531 pF to 1.59 μF  
 (Depending on the measurement frequency)  
 Measurement signal level -40.0 dBm to +1.0 dBm  
 Basic accuracy Z : 0.65% rdg θ: 0.38°

### IMPEDANCE ANALYZER IM7585

Measurement frequency **1 MHz to 1.3 GHz**  
 Measurement range L : 0.0123 nH to 0.795 mH  
 C : 0.0245 pF to 1.59 μF  
 (Depending on the measurement frequency)  
 Measurement signal level -40.0 dBm to +1.0 dBm  
 Basic accuracy Z : 0.65% rdg θ: 0.38°

### IMPEDANCE ANALYZER IM7587

Measurement frequency **1 MHz to 3 GHz**  
 Measurement range L : 0.0053 nH to 0.795 mH  
 C : 0.011 pF to 1.59 μF  
 (Depending on the measurement frequency)  
 Measurement signal level -40.0 dBm to +1.0 dBm  
 Basic accuracy Z : 0.65% rdg θ: 0.38°



Photo: IM7585

A rich lineup covering a wide range of measurement frequencies



LCR Meters

## 3 GHz High Frequency Testing

### IMPEDANCE ANALYZER IM7587

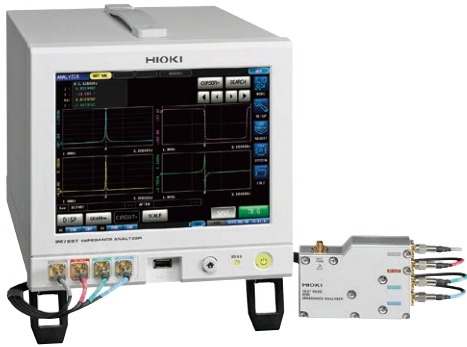

**LAN**

**USB<sub>2.0</sub>**

**GP-IB**  
option

**RS-232C**  
option

**CE**

**3 Year Warranty**

- 1 MHz to 3 GHz testing source frequency
- Fastest test speed of 0.5 msec (Analog measurement time)
- 0.07% measured value variability (When measuring a 1 nH coil at 3 GHz)
- ±0.65% rdg basic accuracy
- Half-rack size body and palm-sized test head
- Comprehensive contact check (via DCR testing, Hi-Z reject or waveform judgment)
- Make frequency sweeps, level sweeps and time interval measurements in Analyzer Mode

Model No. (Order Code) **IM7587-01** (Connection cable 1 m is bundled)  
**IM7587-02** (Connection cable 2 m is bundled)

The instrument does not ship with a test fixture or probe. A test fixture designed specifically for use with the Impedance Analyzer is required.

#### ■ Basic specifications (Accuracy guaranteed for 1 year)

Measurement modes	LCR mode, Analyzer mode (sweeps with measurement frequency and measurement level), Continuous measurement mode
Measurement parameters	Z, Y, θ, Rs (ESR), Rp, X, G, B, Cs, Cp, Ls, Lp, D (tanδ), Q
Measurable range	100 mΩ to 5 kΩ
Display range	Z: 0.00 m to 9.99999 GΩ / Rs, Rp, X: ±(0.00 m to 9.99999 GΩ) Ls, Lp: ±(0.00000 n to 9.99999 GH) / Q: ±(0.00 to 9999.99) θ: ±(0.000° to 180.000°), Cs, Cp: ±(0.00000 p to 9.99999 GF) D: ±(0.00000 to 9.99999), Y: (0.000 n to 9.99999 GS) G, B: ±(0.000 n to 9.99999 GS), Δ%: ±(0.000 % to 999.999 %)
Basic accuracy	Z: ±0.65 % rdg θ: ±0.38°
Measurement frequency	1 MHz to 3 GHz (100 kHz setting resolution)
Measurement signal level	Power: -40.0 dBm to +1.0 dBm Voltage: 4 mV to 502 mVrms Current: 0.09 mA to 10.04 mA rms
Output impedance	50 Ω (at 10 MHz)
Display	8.4-inch color TFT with touch screen
Measurement speeds	FAST: 0.5 ms (Analog measurement time, typical value)
Functions	Contact check, Comparator, BIN measurement (classification), Panel loading/saving, Memory function, Equivalent circuit analysis, Correlation compensation
Interfaces	EXT I/O (Handler), USB communication, USB memory, LAN, RS-232C (optional), GP-IB (optional)
Power supply	100 to 240 V AC, 50/60 Hz, 70 VA max.
Dimensions and mass	Main unit: 215 mm (8.46 in) W × 200 mm (7.87 in) H × 348 mm (13.70 in) D, 8.0 kg (282.2 oz) Test head: 90 mm (3.54 in) W × 64 mm (2.52 in) H × 24 mm (0.94 in) D, 300 g (10.58 oz)
Included accessories	Test head ×1, Connection cable ×1, Instruction manual ×1, LCR application disc (Communications user manual) ×1, Power cord ×1

Probe and Test fixtures



**TEST FIXTURE IM9202**  
 Combination use with the IM9200



**SMD TEST FIXTURE IM9201**  
 Combination use with the IM9200



**TEST FIXTURE STAND IM9200**  
 Includes magnifying glass



**ADAPTER IM9906**  
 3.5 mm (0.14 in) male to 7 mm (0.28 in) conversion



**CALIBRATION KIT IM9905**  
 Open/Short/Load set

PC communication



**GP-IB INTERFACE Z3000**



**GP-IB CONNECTOR CABLE 9151-02**  
 2 m (6.56 ft) length



**RS-232C INTERFACE Z3001**



**RS-232C CABLE 9637**  
 For the PC, 9 pin - 9 pin, cross, 1.8 m (5.91 ft) length

## Fastest Measurement Time of 0.5ms and Measurement Stability of 0.07% to Boost Your Production Volume

### IMPEDANCE ANALYZER IM7585



LAN

USB 2.0

GP-IB  
option

RS-232C  
option

CE

3 Year  
Warranty

- 1 MHz to 1.3 GHz testing source frequency
- Fastest test speed of 0.5 msec (Analog measurement time)
- 0.07% measured value variability (when measuring at 1GHz)
- $\pm 0.65\%$  rdg basic accuracy
- Half-rack size body and palm-sized test head
- Comprehensive contact check (via DCR testing, Hi-Z reject or waveform judgment)
- Make frequency sweeps, level sweeps and time interval measurements in Analyzer Mode

Model No. (Order Code) **IM7585-01** (Connection cable 1 m is bundled)  
**IM7585-02** (Connection cable 2 m is bundled)

The instrument does not ship with a test fixture or probe. A test fixture designed specifically for use with the Impedance Analyzer is required.

#### Basic specifications (Accuracy guaranteed for 1 year)

Measurement modes	LCR mode, Analyzer mode (sweeps with measurement frequency and measurement level), Continuous measurement mode
Measurement parameters	Z, Y, $\theta$ , Rs (ESR), Rp, X, G, B, Cs, Cp, Ls, Lp, D ( $\tan\delta$ ), Q
Measurable range	100 m $\Omega$ to 5 k $\Omega$ Z: 0.00 m to 9.99999 G $\Omega$ / Rs, Rp, X: $\pm$ (0.00 m to 9.99999 G $\Omega$ ) Ls, Lp: $\pm$ (0.00000 n to 9.99999 GH) / Q: $\pm$ (0.00 to 9999.99) $\theta$ : $\pm$ (0.000° to 180.000°), Cs, Cp: $\pm$ (0.00000 p to 9.99999 GF) D: $\pm$ (0.00000 to 9.99999), Y: (0.000 n to 9.99999 GS) G, B: $\pm$ (0.000 n to 9.99999 GS), $\Delta\%$ : $\pm$ (0.000 % to 999.999 %)
Display range	
Basic accuracy	Z: $\pm 0.65\%$ rdg $\theta$ : $\pm 0.38^\circ$
Measurement frequency	1 MHz to 1.3 GHz (100 kHz setting resolution)
Measurement signal level	Power: -40.0 dBm to +1.0 dBm Voltage: 4 mV to 502 mVrms Current: 0.09 mA to 10.04 mArms
Output impedance	50 $\Omega$ (at 10 MHz)
Display	8.4-inch color TFT with touch screen
Measurement speeds	FAST: 0.5 ms (Analog measurement time, typical value)
Functions	Contact check, Comparator, BIN measurement (classification), Panel loading/saving, Memory function, Equivalent circuit analysis, Correlation compensation
Interfaces	EXT I/O (Handler), USB communication, USB memory, LAN, RS-232C (optional), GP-IB (optional)
Power supply	100 to 240 V AC, 50/60 Hz, 70 VA max.
Dimensions and mass	Main unit: 215 mm (8.46 in) W $\times$ 200 mm (7.87 in) H $\times$ 348 mm (13.70 in) D, 8.0 kg (282.2 oz) Test head: 90 mm (3.54 in) W $\times$ 64 mm (2.52 in) H $\times$ 24 mm (0.94 in) D, 300 g (10.58 oz)
Included accessories	Test head $\times$ 1, Connection cable $\times$ 1, Instruction manual $\times$ 1, LCR application disc (Communications user manual) $\times$ 1, Power cord $\times$ 1

Probe and Test fixtures



**TEST FIXTURE IM9202**  
Combination use with the IM9200



**SMD TEST FIXTURE IM9201**  
Combination use with the IM9200



**TEST FIXTURE STAND IM9200**  
Includes magnifying glass



**ADAPTER (3.5mm/7mm) IM9906**  
3.5 mm (0.14 in) male to 7 mm (0.28 in) conversion



**CALIBRATION KIT IM9905**  
Open/Short/Load set

PC communication



**GP-IB INTERFACE Z3000**



**GP-IB CONNECTOR CABLE 9151-02**  
2 m (6.56 ft) length



**RS-232C INTERFACE Z3001**



**RS-232C CABLE 9637**  
For the PC, 9 pin - 9 pin, cross, 1.8 m (5.91 ft) length

## Fastest Measurement Time of 0.5ms to Boost Your Production Volume

### IMPEDANCE ANALYZER IM7583



LAN

USB 2.0

GP-IB  
option

RS-232C  
option

CE

3 Year  
Warranty

- 1 MHz to 600 MHz testing source frequency
- Fastest test speed of 0.5 msec (Analog measurement time)
- $\pm 0.65\%$  rdg basic accuracy
- Half-rack size body and palm-sized test head
- Comprehensive contact check (via DCR testing, Hi-Z reject or waveform judgment)
- Make frequency sweeps, level sweeps and time interval measurements in Analyzer Mode

Model No. (Order Code) **IM7583-01** (Connection cable 1 m is bundled)  
**IM7583-02** (Connection cable 2 m is bundled)

The instrument does not ship with a test fixture or probe. A test fixture designed specifically for use with the Impedance Analyzer is required.

#### Basic specifications (Accuracy guaranteed for 1 year)

Measurement modes	LCR mode, Analyzer mode (Sweeps with measurement frequency and measurement level), Continuous measurement mode
Measurement parameters	Z, Y, $\theta$ , Rs (ESR), Rp, X, G, B, Cs, Cp, Ls, Lp, D ( $\tan\delta$ ), Q
Measurable range	100 m $\Omega$ to 5 k $\Omega$ Z: 0.00 m to 9.99999 G $\Omega$ / Rs, Rp, X: $\pm$ (0.00 m to 9.99999 G $\Omega$ ) Ls, Lp: $\pm$ (0.00000 n to 9.99999 GH) / Q: $\pm$ (0.00 to 9999.99) $\theta$ : $\pm$ (0.000° to 180.000°), Cs, Cp: $\pm$ (0.00000 p to 9.99999 GF) D: $\pm$ (0.00000 to 9.99999), Y: (0.000 n to 9.99999 GS) G, B: $\pm$ (0.000 n to 9.99999 GS), $\Delta\%$ : $\pm$ (0.000 % to 999.999 %)
Display range	
Basic accuracy	Z: $\pm 0.65\%$ rdg $\theta$ : $\pm 0.38^\circ$
Measurement frequency	1 MHz to 600 MHz (100 kHz setting resolution)
Measurement signal level	Power: -40.0 dBm to +1.0 dBm Voltage: 4 mV to 502 mVrms Current: 0.09 mA to 10.04 mArms
Output impedance	50 $\Omega$ (at 10 MHz)
Display	8.4-inch color TFT with touch screen
Measurement speeds	FAST: 0.5 ms (Analog measurement time, typical value)
Functions	Contact check, Comparator, BIN measurement (classification), Panel loading/saving, Memory function, Equivalent circuit analysis, Correlation compensation
Interfaces	EXT I/O (Handler), USB communication, USB memory, LAN, RS-232C (optional), GP-IB (optional)
Power supply	100 to 240 V AC, 50/60 Hz, 70 VA max.
Dimensions and mass	Main unit: 215 mm (8.46 in) W $\times$ 200 mm (7.87 in) H $\times$ 348 mm (13.70 in) D, 8.0 kg (282.2 oz) Test head: 90 mm (3.54 in) W $\times$ 64 mm (2.52 in) H $\times$ 24 mm (0.94 in) D, 300 g (10.58 oz)
Included accessories	Test head $\times$ 1, Connection cable $\times$ 1, Instruction manual $\times$ 1, LCR application disc (Communications user manual) $\times$ 1, Power cord $\times$ 1

Probe and Test fixtures



**TEST FIXTURE IM9202**  
Combination use with the IM9200



**SMD TEST FIXTURE IM9201**  
Combination use with the IM9200



**TEST FIXTURE STAND IM9200**  
Includes magnifying glass



**ADAPTER (3.5mm/7mm) IM9906**  
3.5 mm (0.14 in) male to 7 mm (0.28 in) conversion



**CALIBRATION KIT IM9905**  
Open/Short/Load set

PC communication



**GP-IB INTERFACE Z3000**



**GP-IB CONNECTOR CABLE 9151-02**  
2 m (6.56 ft) length



**RS-232C INTERFACE Z3001**



**RS-232C CABLE 9637**  
For the PC, 9 pin - 9 pin, cross, 1.8 m (5.91 ft) length

## 100kHz to 300MHz Measurement Frequency at High Speeds with Superior Repeatability

### IMPEDANCE ANALYZER IM7581



- LAN**
- USB<sub>2.0</sub>**
- GP-IB**  
option
- RS-232C**  
option
- CE**
- 3 year**  
Warranty

- 100 kHz to 300 MHz testing source frequency
- Fastest test speed of 0.5 msec (Analog measurement time)
- ±0.72% rdg basic accuracy
- Half-rack size body and palm-sized test head
- Comprehensive contact check (via DCR testing, Hi-Z reject or waveform judgment)
- Make frequency sweeps, level sweeps and time interval measurements in Analyzer Mode

Model No. (Order Code) **IM7581-01** (Connection cable 1 m is bundled)  
**IM7581-02** (Connection cable 2 m is bundled)

The instrument does not ship with a test fixture or probe. A test fixture designed specifically for use with the Impedance Analyzer is required.

#### Basic specifications (Accuracy guaranteed for 1 year)

Measurement modes	LCR mode, Analyzer mode (Sweeps with measurement frequency and measurement level), Continuous measurement mode
Measurement parameters	Z, Y, $\theta$ , Rs (ESR), Rp, X, G, B, Cs, Cp, Ls, Lp, D (tan $\delta$ ), Q
Measurable range	100 m $\Omega$ to 5 k $\Omega$
Display range	Z: 0.00 m to 9.99999 G $\Omega$ / Rs, Rp, X: $\pm$ (0.00 m to 9.99999 G $\Omega$ ) Ls, Lp: $\pm$ (0.00000 n to 9.99999 GH) / Q: $\pm$ (0.00 to 9999.99) $\theta$ : $\pm$ (0.000° to 180.000°), Cs, Cp: $\pm$ (0.00000 p to 9.99999 GF) D: $\pm$ (0.00000 to 9.99999), Y: (0.000 n to 9.99999 GS) G, B: $\pm$ (0.000 n to 9.99999 GS), $\Delta\%$ : $\pm$ (0.000 % to 999.999 %)
Basic accuracy	Z: $\pm$ 0.72 % rdg $\theta$ : $\pm$ 0.41°
Measurement frequency	100.00 kHz to 300.00 MHz (5 digits resolution)
Measurement signal level	Power: -40.0 dBm to +7.0 dBm Voltage: 4 mV to 1001 mVrms Current: 0.09 mA to 20.02 mArms User-configured power, voltage, and current
Output impedance	50 $\Omega$
Display	8.4-inch color TFT with touch screen
Measurement speeds *1	FAST: 0.5 ms / MED: 0.9 ms / SLOW: 2.1 ms / SLOW2: 3.7 ms *1 Analog measurement time
Functions	Contact check, Comparator, BIN measurement (classification), Panel loading/saving, Memory function, Equivalent circuit analysis, Correlation compensation
Interfaces	Handler, USB, LAN, GP-IB (optional), RS-232C (optional)
Power supply	100 to 240 V AC, 50/60 Hz, 70 VA max.
Dimensions and mass	Main unit: 215 mm (8.46 in) W $\times$ 200 mm (7.87 in) H $\times$ 268 mm (10.55 in) D, 6.5 kg (229.3 oz) Test head: 61 mm (2.40 in) W $\times$ 55 mm (2.17 in) H $\times$ 24 mm (0.94 in) D, 175 g (6.2 oz)
Included accessories	Test head $\times$ 1, Connection cable $\times$ 1, Power cord $\times$ 1, Instruction manual $\times$ 1, LCR application disc (Communications user manual) $\times$ 1

Probe and Test fixtures						PC communication				
	TEST FIXTURE IM9202 Combination use with the IM9200	SMD TEST FIXTURE IM9201 Combination use with the IM9200	TEST FIXTURE STAND IM9200 Includes magnifying glass	ADAPTER (3.5mm/7mm) IM9906 3.5 mm (0.14 in) male to 7 mm (0.28 in) conversion	CALIBRATION KIT IM9905 Open/Short/Load set		GP-IB INTERFACE Z3000	GP-IB CONNECTOR CABLE 9151-02 2 m (6.56 ft) length	RS-232C INTERFACE Z3001	RS-232C CABLE 9637 For the PC, 9 pin - 9 pin, cross, 1.8 m (5.91 ft) length

## 1MHz to 300MHz Measurement Frequency at High Speeds with Superior Repeatability

### IMPEDANCE ANALYZER IM7580A



- LAN**
- USB<sub>2.0</sub>**
- GP-IB**  
option
- RS-232C**  
option
- CE**
- 3 year**  
Warranty

- 1 MHz to 300 MHz testing source frequency
- Fastest test speed of 0.5 msec
- ±0.72% rdg basic accuracy
- Half-rack size body and palm-sized test head
- Comprehensive contact check (via DCR testing, Hi-Z reject or waveform judgment)
- Make frequency sweeps, level sweeps and time interval measurements in Analyzer Mode

Model No. (Order Code) **IM7580A-1** (Connection cable 1 m is bundled)  
**IM7580A-2** (Connection cable 2 m is bundled)

The instrument does not ship with a test fixture or probe. A test fixture designed specifically for use with the Impedance Analyzer is required.

#### Basic specifications (Accuracy guaranteed for 1 year)

Measurement modes	LCR mode, Analyzer mode (Sweeps with measurement frequency and measurement level), Continuous measurement mode
Measurement parameters	Z, Y, $\theta$ , Rs (ESR), Rp, X, G, B, Cs, Cp, Ls, Lp, D (tan $\delta$ ), Q
Measurable range	100 m $\Omega$ to 5 k $\Omega$
Display range	Z: 0.00 m to 9.99999 G $\Omega$ / Rs, Rp, X: $\pm$ (0.00 m to 9.99999 G $\Omega$ ) Ls, Lp: $\pm$ (0.00000 n to 9.99999 GH) / Q: $\pm$ (0.00 to 9999.99) $\theta$ : $\pm$ (0.000° to 180.000°), Cs, Cp: $\pm$ (0.00000 p to 9.99999 GF) D: $\pm$ (0.00000 to 9.99999), Y: (0.000 n to 9.99999 GS) G, B: $\pm$ (0.000 n to 9.99999 GS), $\Delta\%$ : $\pm$ (0.000 % to 999.999 %)
Basic accuracy	Z: $\pm$ 0.72 % rdg $\theta$ : $\pm$ 0.41°
Measurement frequency	1.0000 MHz to 300.00 MHz (5 digits resolution)
Measurement signal level	Power: -40.0 dBm to +7.0 dBm Voltage: 4 mV to 1001 mVrms Current: 0.09 mA to 20.02 mArms
Output impedance	50 $\Omega$
Display	8.4-inch color TFT with touch screen
Measurement speeds	FAST: 0.5 ms (Analog measurement time, typical value)
Functions	Contact check, Comparator, BIN measurement (classification), Panel loading/saving, Memory function, Equivalent circuit analysis, Correlation compensation
Interfaces	EXT I/O (Handler), USB communication, USB memory, LAN, RS-232C (optional), GP-IB (optional)
Power supply	100 to 240 V AC, 50/60 Hz, 70 VA max.
Dimensions and mass	Main unit: 215 mm (8.46 in) W $\times$ 200 mm (7.87 in) H $\times$ 268 mm (10.55 in) D, 6.5 kg (229.3 oz) Test head: 61 mm (2.40 in) W $\times$ 55 mm (2.17 in) H $\times$ 24 mm (0.94 in) D, 175 g (6.2 oz)
Included accessories	Test head $\times$ 1, Connection cable $\times$ 1, Instruction manual $\times$ 1, LCR application disc (Communications user manual) $\times$ 1, Power cord $\times$ 1

Probe and Test fixtures						PC communication				
	TEST FIXTURE IM9202 Combination use with the IM9200	SMD TEST FIXTURE IM9201 Combination use with the IM9200	TEST FIXTURE STAND IM9200 Includes magnifying glass	ADAPTER (3.5mm/7mm) IM9906 3.5 mm (0.14 in) male to 7 mm (0.28 in) conversion	CALIBRATION KIT IM9905 Open/Short/Load set		GP-IB INTERFACE Z3000	GP-IB CONNECTOR CABLE 9151-02 2 m (6.56 ft) length	RS-232C INTERFACE Z3001	RS-232C CABLE 9637 For the PC, 9 pin - 9 pin, cross, 1.8 m (5.91 ft) length

## For R & D applications of Electrochemical Components and Materials, Batteries, and EDLCs

### CHEMICAL IMPEDANCE ANALYZER IM3590



USB 2.0

LAN

GP-IB

RS-232C

CE

3 Year Warranty

LCR Meters

- Broad 1 mHz to 200 kHz signal source range supports measurements of ion behavior and solution resistance
- Continuous measuring and high-speed testing of LCR and sweep measurements with a single instrument
- Measure internal impedance of batteries with no load
- Perform high-speed sweep measurements in as little as 2 ms
- Basic accuracy of  $\pm 0.05\%$  is ideal for applications from component testing to R&D
- Measure LCR impedance for Cole-Cole plots and equivalent-circuit analyses of electrochemical components and materials

#### Basic specifications (Accuracy guaranteed for 1 year)

Measurement modes	LCR mode, Continuous measurement mode (LCR mode / Analyzer mode), Analyzer mode (Sweeps with measurement frequency and measurement level, temperature characteristics, equivalent circuit analysis)
Measurement parameters	Z, Y, $\theta$ , Rs (ESR), Rp, Rdc (DC resistance), X, G, B, Cs, Cp, Ls, Lp, D (tan $\delta$ ), Q, T, $\sigma$ (conductivity), $\epsilon$ (dielectric constant)
Measurement range	100 m $\Omega$ to 100 M $\Omega$ , 10 ranges (All parameters are determined according to Z)
Display range	Z, Y, Rs, Rp, Rdc, X, G, B, Ls, Lp, Cs, Cp, $\sigma$ , $\epsilon$ : $\pm(0.00000$ [unit] to $9.999999$ [unit]), Absolute value display for Z and Y only $\theta$ : $\pm(0.000^\circ$ to $180.000^\circ)$ , D : $\pm(0.00000$ to $9.999999)$ Q : $\pm(0.00$ to $99999.9)$ , $\Delta$ % : $\pm(0.00000\%$ to $999.9999\%)$ T : $-10.0^\circ\text{C}$ to $99.9^\circ\text{C}$ $\sigma$ , $\epsilon$ : $\pm(0.00000$ [unit] to $999.9999$ [unit])
Basic accuracy	Z: $\pm 0.05\%$ rdg $\theta$ : $\pm 0.03^\circ$
Measurement frequency	1 mHz to 200 kHz (5 digits setting resolution, minimum resolution 1 mHz)
Measurement signal level	Normal mode: V mode/CV mode: 5 mV to 5 Vrms, 1 mVrms steps CC mode: 10 $\mu\text{A}$ to 50 mArms, 10 $\mu\text{A}$ Arms steps Low impedance high accuracy mode: V mode/CV mode: 5 mV to 2.5 Vrms, 1 mVrms steps CC mode: 10 $\mu\text{A}$ to 100 mArms, 10 $\mu\text{A}$ Arms steps
Output impedance	Normal mode: 100 $\Omega$ , Low impedance high accuracy mode: 25 $\Omega$
Display	5.7-inch color TFT, display can be set to ON/OFF
Measurement time	2 ms (1 kHz, FAST, display OFF, representative value)
Functions	DC bias measurement, DC resistance temperature compensation (converted reference temperature is displayed), Temperature measurement, Battery measurement (Automatic DC biasing system), Comparator, BIN measurement (classification), Panel loading/saving, Memory function
Interfaces	EXT I/O (Handler), USB communication (high-speed), USB memory Optional: Choose 1 from RS-232C, GP-IB, or LAN
Power supply	100 to 240 V AC, 50/60 Hz, 50 VA max.
Dimensions and mass	330 mm (12.99 in) W $\times$ 119 mm (4.69 in) H $\times$ 168 mm (6.61 in) D, 3.1 kg (109.3 oz)
Included accessories	Power cord $\times$ 1, Instruction manual $\times$ 1, CD-R (Communication instruction manual and sample software [Communications control, accuracy calculation, and screen capture functionality]) $\times$ 1

Model No. (Order Code) **IM3590** (For electrochemical components)

This product is not supplied with measurement probes or test fixtures. Please select and purchase the measurement probe or test fixture options appropriate for your application separately.  
For an RS-232C connection: A crossover cable for interconnection can be used. You can use the RS-232C Cable 9637 without hardware flow control.

#### Shared options for IM3590, IM3533, IM3523

\*Please see the individual product catalog for more information

Probe and Test fixtures



**SMD TEST FIXTURE IM9110**  
Direct connection two-terminal measurement type for measuring SMDs, DC to 1 MHz, measurable sample sizes: 080804 (inch)



**SMD TEST FIXTURE IM9100**  
Direct connection type, For measuring SMDs with electrodes on the bottom, DC to 8 MHz, measurable sample sizes: 01005 to 0402 (inch), 0402 to 1005 (metric)



**4-TERMINAL PROBE L2000**  
Cable length 1 m (3.28 ft), DC to 8 MHz, impedance characteristics of 50  $\Omega$ , 4-terminal pair configuration, measurable conductor diameter:  $\phi 0.3$  (0.01 in) to 5 mm (0.20 in)



**PINCHER PROBE L2001**  
Cable length 73 cm (28.74 ft), DC to 8 MHz, impedance characteristics of 50  $\Omega$ , 4-terminal pair configuration, tip electrode spacing: 0.3 (0.01 in) to 6 mm (0.24 in)



**CONTACT TIPS IM9901**  
To replace the tip on the L2001, regular size, bundled with the L2001



**CONTACT TIPS IM9902**  
To replace the tip on the L2001, small size



**4-TERMINAL PROBE 9140-10**  
Cable length 1 m (3.28 ft), DC to 200 kHz, 50  $\Omega$ , measurable conductor diameter:  $\phi 0.3$  mm (0.01 in) to 5 mm (0.20 in)



**TEST FIXTURE 9261-10**  
Cable length 1 m (3.28 ft), DC to 8 MHz, impedance characteristics of 50  $\Omega$ , 4-terminal pair configuration, measurable conductor diameter:  $\phi 0.3$  (0.01 in) to 1.5 mm (0.06 in)

When using the 9268-10 or 9269-10, external constant-voltage and constant-current sources are required.



**TEST FIXTURE 9262**  
Direct connection type, DC to 8 MHz, measurable conductor diameter:  $\phi 0.3$  (0.01 in) to 2 mm (0.08 in)



**SMD TEST FIXTURE 9263**  
Direct connection type, DC to 8 MHz, test sample dimensions: 1 mm (0.04 in) to 10 mm (0.39 in)



**4-TERMINAL PROBE 9500-10**  
Cable length 1 m (3.28 ft), DC to 200 kHz, impedance characteristics of 50  $\Omega$ , measurable conductor diameter:  $\phi 0.3$  mm (0.01 in) to 2 mm (0.08 in)



**SMD TEST FIXTURE 9677**  
Direct connection type, For measuring SMDs with electrodes on the side; DC to 120 MHz, test sample dimensions: 3.5 mm  $\pm 0.5$  mm (0.14 in  $\pm 0.02$  in)



**SMD TEST FIXTURE 9699**  
Direct connection type, For measuring SMDs with electrodes on the bottom; DC to 120 MHz, test sample dimensions: 1.0 mm (0.04 in) to 4.0 mm (0.16 in) wide, max. 1.5 mm (0.06 in) high



**DC BIAS VOLTAGE UNIT 9268-10**  
Direct connection type, 40 Hz to 8 MHz, maximum applied voltage of DC  $\pm 40$  V



**DC BIAS CURRENT UNIT 9269-10**  
Direct connection type, 40 Hz to 2 MHz, maximum applied current of DC 2 A

Temperature probe



**SHEATH TYPE TEMPERATURE PROBE 9478**  
Pt100, Tip dia.  $\phi 2.3$  mm (0.09 in), Cord length 1 m (3.28 ft), Waterproof construction

\*Use with only for the IM3590, IM3533

PC communication



**GP-IB INTERFACE Z3000**



**RS-232C INTERFACE Z3001**



**LAN INTERFACE Z3002**



**GP-IB CONNECTOR CABLE 9151-02**  
2 m (6.56 ft) length

## Single Device Solution for High Speed Testing and Frequency Sweeping

### IMPEDANCE ANALYZER IM3570



- LAN
- USB 2.0
- GP-IB
- RS-232C
- CE
- 3 Year Warranty

- LCR measurement, DCR measurement, sweep measurement, continuous measurement and high-speed testing achieved with one instrument
- High-speed testing, achieving maximum speeds of 1.5ms (1 kHz) and 0.5ms (100kHz) in LCR mode
- High-accuracy measurements, basic accuracy of Z parameter:  $\pm 0.08\%$
- Perfect impedance analyzer for testing the resonance characteristics of piezoelectric elements, C-D and low ESR measurement of functional polymer capacitors, DCR and L-Q measurement of inductors (coils and transformers)
- Perform frequency sweeps, level sweeps, and time interval measurements in analyzer mode

Model No. (Order Code) **IM3570**

This product is not supplied with measurement probes or test fixtures. Please select and purchase the measurement probe or test fixture options appropriate for your application separately. For an RS-232C connection: A crossover cable for interconnection can be used. You can use the RS-232C CABLE 9637 without hardware flow control.

#### Basic specifications (Accuracy guaranteed for 1 year)

Measurement modes	LCR mode, Analyzer mode (Sweeps with measurement frequency and measurement level), Continuous measurement mode
Measurement parameters	Z, Y, $\theta$ , Rs (ESR), Rp, Rdc (DC resistance), X, G, B, Cs, Cp, Ls, Lp, D (tan $\delta$ ), Q
Measurement range	100 m $\Omega$ to 100 M $\Omega$ , 12 ranges (All parameters are determined according to Z)
Display range	Z, Y, Rs, Rp, Rdc, X, G, B, Ls, Lp, Cs, Cp : $\pm(0.000000 \text{ [unit]} \text{ to } 9.9999999 \text{ [unit]})$ , Absolute value display for Z and Y only $\theta : \pm(0.000^\circ \text{ to } 180.000^\circ)$ , D : $\pm(0.000000 \text{ to } 9.999999)$ Q : $\pm(0.00 \text{ to } 99999.99)$ , $\Delta \% : \pm(0.0000\% \text{ to } 999.9999\%)$
Basic accuracy	Z $\pm 0.08\%$ rdg $\theta : \pm 0.05^\circ$
Measurement frequency	4 Hz to 5 MHz (5 digits setting resolution, minimum resolution 10 mHz)
Measurement signal level	Normal mode: V mode/CV mode: 5 mV to 5 Vrms (up to 1 MHz) 10 mV to 1 Vrms (1.0001 MHz to 5 MHz), 1 mVrms steps CC mode: 10 $\mu$ A to 50 mArms (up to 1 MHz) 10 $\mu$ A to 10 mArms (1.0001 MHz to 5 MHz), 10 $\mu$ Arms steps Low impedance high accuracy mode: V mode/CV mode: 5 mV to 1 Vrms (up to 100 kHz), 1 mVrms steps CC mode: 10 $\mu$ A to 100 mArms (100 m $\Omega$ and 1 $\Omega$ ranges of up to 100 kHz), 10 $\mu$ Arms steps
Output impedance	Normal mode: 100 $\Omega$ , Low impedance high accuracy mode: 10 $\Omega$
Display	5.7-inch color TFT, display can be set to ON/OFF
Measurement time	0.5 ms (100 kHz, FAST, display OFF, representative value)
Functions	DC bias measurement, Comparator, BIN measurement (classification), Panel loading/saving, Memory function
Interfaces	EXT I/O (handler), RS-232C, GP-IB, USB communication, USB memory, LAN
Power supply	90 to 264 V AC, 50/60 Hz, 150 VA max.
Dimensions and mass	330 mm (12.99 in) W $\times$ 119 mm (4.69 in) H $\times$ 307 mm (12.09 in) D, 5.8 kg (204.6 oz)
Included accessories	Power cord $\times$ 1, Instruction manual $\times$ 1, CD-R (Communication instruction manual and sample software) $\times$ 1

LCR Meters

**SMD TEST FIXTURE IM9110**  
Direct connection two-terminal measurement type for measuring SMDs, DC to 1 MHz, measurable sample sizes: 008004 (inch)

**SMD TEST FIXTURE IM9100**  
Direct connection type, For measuring SMDs with electrodes on the bottom, DC to 8 MHz, measurable sample sizes: 01005 to 0402 (inch), 0402 to 1005 (metric)

**4-TERMINAL PROBE L2000**  
Cable length 1 m (3.28 ft), DC to 8 MHz, impedance characteristics of 50  $\Omega$ , 4-terminal pair configuration, measurable conductor diameter:  $\phi 0.3$  (0.01 in) to 5 mm (0.20 in)

**PINCHER PROBE L2001**  
Cable length 73 cm (28.74 ft), DC to 8 MHz, impedance characteristics of 50  $\Omega$ , 4-terminal pair configuration, tip electrode spacing: 0.3 (0.01 in) to 6 mm (0.24 in)

**CONTACT TIPS IM9901**  
To replace the tip on the L2001, regular size, bundled with the L2001

**CONTACT TIPS IM9902**  
To replace the tip on the L2001, small size

**4-TERMINAL PROBE 9140-10**  
Cable length 1 m (3.28 ft), DC to 200 kHz, 50  $\Omega$ , measurable conductor diameter:  $\phi 0.3$  mm (0.01 in) to 5 mm (0.20 in)

**TEST FIXTURE 9261-10**  
Cable length 1 m (3.28 ft), DC to 8 MHz, impedance characteristics of 50  $\Omega$ , 4-terminal pair configuration, measurable conductor diameter:  $\phi 0.3$  (0.01 in) to 1.5 mm (0.06 in)

**TEST FIXTURE 9262**  
Direct connection type, DC to 8 MHz, measurable conductor diameter:  $\phi 0.3$  (0.01 in) to 2 mm (0.08 in)

**SMD TEST FIXTURE 9263**  
Direct connection type, DC to 8 MHz, test sample dimensions: 1 mm (0.04 in) to 10 mm (0.39 in)

**4-TERMINAL PROBE 9500-10**  
Cable length 1 m (3.28 ft), DC to 200 kHz, impedance characteristics of 50  $\Omega$ , measurable conductor diameter:  $\phi 0.3$  mm (0.01 in) to 2 mm (0.08 in)

**SMD TEST FIXTURE 9677**  
Direct connection type, For measuring SMDs with electrodes on the side, DC to 120 MHz, test sample dimensions: 3.5 mm  $\pm$ 0.5 mm (0.14 in  $\pm$ 0.02 in)

**SMD TEST FIXTURE 9699**  
Direct connection type, For measuring SMDs with electrodes on the bottom, DC to 120 MHz, test sample dimensions: 1.0 mm (0.04 in) to 4.0 mm (0.16 in) wide, max. 1.5 mm (0.06 in) high

**DC BIAS VOLTAGE UNIT 9268-10**  
Direct connection type, 40 Hz to 8 MHz, maximum applied voltage of DC  $\pm 40$  V

**DC BIAS CURRENT UNIT 9269-10**  
Direct connection type, 40 Hz to 2 MHz, maximum applied current of DC 2 A

**Factory-installer option**  
EQUIVALENT CIRCUIT ANALYSIS FIRMWARE IM9000 For the IM3570 (Factory-installed option)

**GP-IB CONNECTOR CABLE 9151-02**  
2 m (6.56 ft) length

When using the 9268-10 or 9269-10, external constant-voltage and constant-current sources are required.

Note: Customers who have purchased the Impedance Analyzer IM3570 can add the Equivalent Circuit Analysis Firmware IM9000 function. Please contact your local HIOKI representative.

## Simple Circuit Analysis & Detailed Acceptance/Rejection Decision-Making

### EQUIVALENT CIRCUIT ANALYSIS FIRMWARE IM9000

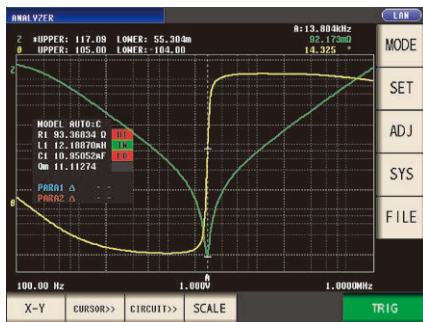

- The IM9000 can automatically select the equivalent circuit model from the five typical models to minimize the differences between the measured values and the ideal frequency characteristics derived from the analysis results
- An acceptance/rejection decision can be made for the L, C, and R elements comprising a part and the resonance sharpness (mechanical quality coefficient)
- A detailed decision can be made on the elements using the resonance of a piezoelectric element or inductor

Model No. (Order Code) **IM9000** (Factory option firmware for the IM3570)

Note: The IM9000 is not included in the standard package. To use the IM9000 function, specify the option upon purchase. Customers who have purchased the Impedance Analyzer IM3570 can add the Equivalent Circuit Analysis Firmware IM9000 function. Please contact your local HIOKI representative.

#### Basic specifications

Three-element model	Equivalent circuit model: Four models for Coil, Resistance, Capacitor Measurement items: L1 (Inductance), C1 (Capacitance), R1 (Resistance), Qm (Resonance sharpness), fr (Resonance frequency) / fa (Anti-resonance frequency)
Four-element model	Equivalent circuit model: One model for Piezoelectric element Measurement items: L1 (Inductance), C1 (Capacitance), R1 (Resistance), C0 (Parallel capacitance), Qm (Resonance sharpness or mechanical quality coefficient) fr (Resonance frequency), fa (Anti-resonance frequency), fs (Series resonance frequency), fp (Parallel resonance frequency), fm (Maximum admittance frequency), fn (Minimum admittance frequency), fl (Maximum susceptance frequency), f2 (Minimum susceptance frequency)
Other functions	Simulation: Enables displaying and comparing the ideal frequency characteristics graph derived from the analysis results or the values specified by the user Comparator: Runs a comparator on the analysis results and outputs the decision results to screen, EXT. I/O
X-Y display	Cole-Cole plot, Admittance circle display

#### Equivalent Circuit Model and Measurement Items

##### Three-element model

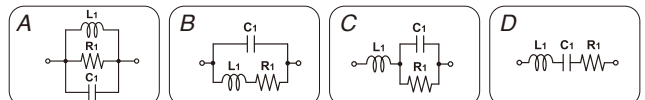

##### Four-element model

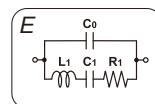

## Measurement Frequency from DC, 4 Hz to 8 MHz

### LCR METER IM3536



LAN

USB 2.0

GP-IB

RS-232C

CE

3 Year Warranty

- DC, 4 Hz to 8 MHz\* measurement frequency  
\*Can be customized up to 10 MHz. Please contact your Hioki distributor or subsidiary for more information.
- High-speed measurement of 1 ms (fastest time)
- High-precision measurement of  $\pm 0.05\%$  rdg (representative value)
- Guaranteed accuracy range from 1 m $\Omega$ , low-impedance measurement with unmatched repeatability
- DC bias function: Measure under conditions simulating actual use or in accordance with industry standards
- Exceptional specifications and cost-performance for a wide range of applications, from R&D to production lines

Model No. (Order Code) **IM3536**

**IM3536-01** (Special order products up to 10 MHz)

This product is not supplied with measurement probes or test fixtures. Please select and purchase the measurement probe or test fixture options appropriate for your application separately. All probes are constructed with a 1.5D-2V coaxial cable. For an RS-232C connection: A crossover cable for interconnection can be used. You can use the RS-232C CABLE 9637 without hardware flow control.

#### Basic specifications (Accuracy guaranteed for 1 year)

Measurement modes	LCR (Measurement with single condition), Continuous testing (Continuous measurement under saved conditions)
Measurement parameters	Z, Y, $\theta$ , X, G, B, Q, Rdc (DC resistance), Rs (ESR), Rp, Ls, Lp, Cs, Cp, D (tan $\delta$ ), $\sigma$ , $\epsilon$
Measurement range	100 m $\Omega$ to 100 M $\Omega$ , 10 ranges (All parameters are determined according to Z)
Display range	Z: 0.00 m to 9.999999 G $\Omega$ , Y: 0.000 n to 9.999999 GS, $\theta$ : $\pm$ (0.000° to 180.000°), Q: $\pm$ (0.00 to 9999.99), Rdc: $\pm$ (0.00 m to 9.99999 G $\Omega$ ), D: $\pm$ (0.00000 to 9.99999), $\Delta\%$ : $\pm$ (0.000 % to 999.999 %), or other
Basic accuracy	Z: $\pm 0.05\%$ rdg $\theta$ : $\pm 0.03^\circ$ (representative value, Measurable range: 1 m $\Omega$ to 200 M $\Omega$ )
Measurement frequency	[Normal mode: V mode/CV mode] 4 Hz to 1.0000 MHz: 10 mV to 5 Vrms (maximum 50 mArms) 1.0001 MHz to 8 MHz: 10 mV to 1 Vrms (maximum 10mArms) [Low impedance high accuracy mode: V mode/CV mode] 4 Hz to 1.0000 MHz: 10 mV to 1 Vrms (maximum 100 mArms) [Normal mode: CC mode] 4 Hz to 1.0000 MHz: 10 $\mu$ A to 50 mArms (maximum 5 Vrms) 1.0001 MHz to 8 MHz: 10 $\mu$ A to 10 mArms (maximum 1 Vrms) [Low impedance high accuracy mode: CC mode] 4 Hz to 1.0000 MHz: 10 $\mu$ A to 100 mArms (maximum 1 Vrms) [DC resistance measurement] Measurement signal level: Fixed at 1 V
Measurement signal level	
DC bias measurement	Generating range: DC voltage 0 V to 2.50 V (10 mV resolution) In low Z high accuracy mode: 0 V to 1 V (10 mV resolution)
Output impedance	Normal mode: 100 $\Omega$ , Low impedance high accuracy mode: 10 $\Omega$
Display	5.7-inch color TFT with touch panel
Functions	Comparator, BIN measurement (10 categories for 2 measurement parameters), Trigger function, Open/short compensation, Contact check, Panel loading/saving, Memory function
Interfaces	EXT. I/O (HANDLER), USB, USB flash drive, LAN, GP-IB, RS-232C, BCD
Power supply	100 to 240 V AC, 50/60 Hz, 50 VA max.
Dimensions and mass	330 mm (12.99 in) W $\times$ 119 mm (4.69 in) H $\times$ 230 mm (9.06 in) D, 4.2 kg (148.1 oz)
Included accessories	Power cord $\times$ 1, Instruction manual $\times$ 1, LCR application disc (Communications user manual) $\times$ 1

Probe and Test fixtures



**SMD TEST FIXTURE IM9110**  
Direct connection two-terminal measurement type for measuring SMDs, DC to 1 MHz, measurable sample sizes: 0.08004 (inch)



**SMD TEST FIXTURE IM9100**  
Direct connection type. For measuring SMDs with electrodes on the bottom. DC to 8 MHz, measurable sample sizes: 0.1005 to 0.402 (inch), 0.402 to 10.05 (metric)



**4-TERMINAL PROBE L2000**  
Cable length 1 m (3.28 ft), DC to 8 MHz, impedance characteristics of 50  $\Omega$ , 4-terminal pair configuration, measurable conductor diameter:  $\phi$ 0.3 (0.01 in) to 5 mm (0.20 in)



**PINCHER PROBE L2001**  
Cable length 73 cm (28.74 ft), DC to 8 MHz, impedance characteristics of 50  $\Omega$ , 4-terminal pair configuration, tip electrode spacing: 0.3 (0.01 in) to 6 mm (0.24 in)



**CONTACT TIPS IM9901**  
To replace the tip on the L2001, regular size, bundled with the L2001



**CONTACT TIPS IM9902**  
To replace the tip on the L2001, small size



**4-TERMINAL PROBE 9140-10**  
Cable length 1 m (3.28 ft), DC to 200 kHz, 50  $\Omega$ , measurable conductor diameter:  $\phi$ 0.3 mm (0.01 in) to 5 mm (0.20 in)



**TEST FIXTURE 9261-10**  
Cable length 1 m (3.28 ft), DC to 8 MHz, impedance characteristics of 50  $\Omega$ , 4-terminal pair configuration, measurable conductor diameter:  $\phi$ 0.3 (0.01 in) to 1.5 mm (0.06 in)



**TEST FIXTURE 9262**  
Direct connection type, DC to 8 MHz, measurable conductor diameter:  $\phi$ 0.3 (0.01 in) to 2 mm (0.08 in)



**SMD TEST FIXTURE 9263**  
Direct connection type, DC to 8 MHz, test sample dimensions: 1 mm (0.04 in) to 10 mm (0.39 in)



**4-TERMINAL PROBE 9500-10**  
Cable length 1 m (3.28 ft), DC to 200 kHz, impedance characteristics of 50  $\Omega$ , measurable conductor diameter:  $\phi$ 0.3 mm (0.01 in) to 2 mm (0.08 in)



**SMD TEST FIXTURE 9677**  
Direct connection type. For measuring SMDs with electrodes on the side; DC to 120 MHz, test sample dimensions: 3.5 mm  $\pm$  0.5 mm (0.14 in  $\pm$  0.02 in)



**SMD TEST FIXTURE 9699**  
Direct connection type. For measuring SMDs with electrodes on the bottom; DC to 120 MHz, test sample dimensions: 1.0 mm (0.04 in) to 4.0 mm (0.16 in) wide, max. 1.5 mm (0.06 in) high

When using the 9268-10 or 9269-10, external constant-voltage and constant-current sources are required.



**DC BIAS VOLTAGE UNIT 9268-10**  
Direct connection type, 40 Hz to 8 MHz, maximum applied voltage of DC  $\pm$ 40 V



**DC BIAS CURRENT UNIT 9269-10**  
Direct connection type, 40 Hz to 2 MHz, maximum applied current of DC 2 A

**RS-232C CABLE 9637**  
1.8 m (5.91 ft) length

**GP-IB CONNECTOR CABLE 9151-02**  
2 m (6.56 ft) length

PC communication

## Ideal for Production Lines of Electronic Parts and Automated Testing

### LCR METER IM3523

New

IM3523A



IM3523

USB 2.0

LAN option (IM3523)

GP-IB option (IM3523)

RS-232C option (IM3523)

CE

3 Year Warranty

- $\pm 0.05\%$  accuracy with wide measurement range (DC, 40 Hz to 200 kHz, 5 mV to 5V, 10  $\mu$ A to 50 mA)
- Non-stop testing over mixed measurement conditions such as C-D (120 Hz) and ESR (100 kHz) at 10 times the speed of previous models (compared with Model 3532-50)
- Built-in comparator and BIN functions
- Rapid 2msec test time

Model No. (Order Code) **IM3523**  
**IM3523A**

This product is not supplied with measurement probes or test fixtures. Please select and purchase the measurement probe or test fixture options appropriate for your application separately. All probes are constructed with a 1.5D-2V coaxial cable. For an RS-232C connection: A crossover cable for interconnection can be used. You can use the RS-232C CABLE 9637 without hardware flow control.

#### Basic specifications (Accuracy guaranteed for 1 year)

	IM3523	IM3523A
Measurement modes	LCR (Measurement with single condition), Continuous testing (Continuous measurement under saved conditions)	
Measurement parameters	Z, Y, $\theta$ , X, G, B, Q, Rdc (DC resistance), Rs (ESR), Rp, Ls, Lp, Cs, Cp, D (tan $\delta$ ), $\sigma$ , $\epsilon$	
Measurement range	100 m $\Omega$ to 100 M $\Omega$ , 10 ranges (All parameters defined in terms of Z.)	
Displayable range	Z, Y, Rs, Rp, Rdc, X, G, B, Ls, Lp, Cs, Cp : $\pm$ (0.00000 [unit] to 9.999999 [unit]) Real value display for Z and Y only $\theta$ : $\pm$ (0.000° to 180.000°), D: $\pm$ (0.00000 to 9.99999) Q: $\pm$ (0.00 to 99999.9), $\Delta\%$ : $\pm$ (0.00000% to 999.999%)	
Basic accuracy	Z: $\pm 0.05\%$ rdg $\theta$ : $\pm 0.03^\circ$	
Measurement frequency	40 Hz to 200 kHz (5 digits setting resolution)	
Measurement signal level	V mode, CV mode: 5 mV to 5 Vrms, 1 mVrms steps CC mode: 10 $\mu$ A to 50 mArms, 10 $\mu$ Arms steps	
Output impedance	100 $\Omega$	
Display	Monochrome LCD	
Measurement time	2 ms (1 kHz, FAST, representative value)	
Functions	Comparator, BIN measurement (classify function), Panel loading/saving, Memory function	
Interfaces	EXT I/O (handler), USB communication (high-speed), Optional: choose 1 from RS-232C, GP-IB, or LAN	EXT I/O (handler), USB communication (high-speed), LAN (100BASE-T)
Power supply	100 to 240 V AC, 50/60 Hz, 50 VA max	
Dimensions and mass	260 mm (10.24 in) W $\times$ 88 mm (3.46 in) H $\times$ 203 mm (7.99 in) D, 2.4 kg (84.7 oz)	
Included accessories	Power cord $\times$ 1, Instruction manual $\times$ 1, CD-R (Includes instruction manual, PC commands and sample software) $\times$ 1	Power cord $\times$ 1, CD-R (Includes instruction manual, PC commands and sample software) $\times$ 1

IM3590, IM3533, IM3523, shared options

Please see shared options for model IM3590

## From R&D Applications to Windings, Coil and Transformer Manufacturing

### LCR METER IM3533



- USB 2.0**
- LAN** option
- GP-IB** option
- RS-232C** option
- CE**
- 3 Year Warranty**

- ±0.05% accuracy with wide measurement range (DC, 1mHz to 200kHz, 5mV to 5V, 10uA to 50mA)
- Non-stop testing over mixed measurement conditions such as C-D and ESR at 10 times the speed of previous models
- Built-in low impedance high precision mode effective for testing low inductance or the ESR of aluminum electrolysis capacitance
- Dedicated modes for measuring transformer winding ratio, mutual inductance and temperature compensated DCR
- Frequency sweep testing (IM3533-01 only)
- 2m/4m cable setting in addition to the standard 0m/1m
- Touch screen with intuitive operation

Model No. (Order Code) **IM3533**  
**IM3533-01** (Advanced function model)

*This product is not supplied with measurement probes or test fixtures. Please select and purchase the measurement probe or test fixture options appropriate for your application separately. All probes are constructed with a 1.5D-2V coaxial cable.  
 For an RS-232C connection: A crossover cable for interconnection can be used. You can use the RS-232C CABLE 9637 without hardware flow control.*

#### Basic specifications (Accuracy guaranteed for 1 year)

	IM3533	IM3533-01
Measurement modes	LCR (Measurement with single condition), Transformer testing (N, M, ΔL), Continuous testing (Continuous measurement under saved conditions) (LCR mode)	LCR (Measurement with single condition), Transformer testing (N, M, ΔL), Analyzer (sweep testing), Continuous Testing (LCR/Analyzer mode)
Measurement parameters	Z, Y, θ, X, G, B, Q, Rdc (DC resistance), Rs (ESR), Rp, Ls, Lp, Cs, Cp, D (tanδ), N, M, ΔL, T	Z, Y, θ, X, G, B, Q, Rdc (DC resistance), Rs (ESR), Rp, Ls, Lp, Cs, Cp, D (tanδ), N, M, ΔL, T
Measurement range	100 mΩ to 100 MΩ, 10 ranges (All parameters defined in terms of Z.)	100 mΩ to 100 MΩ, 10 ranges (All parameters defined in terms of Z.)
Displayable range	Z, Y, Rs, Rp, Rdc, X, G, B, Ls, Lp, Cs, Cp : ± (0.00000 [unit] to 9.99999G [unit]) Real value display for Z and Y only θ: ± (0.000° to 180.000°), D: ± (0.00000 to 9.99999) Q: ± (0.00 to 99999.9), Δ: ± (0.0000% to 999.999%), T: -10.0°C to 99.9°C	Z: ± (0.005% rdg θ: ±0.03°
Basic accuracy	Z: ±0.05% rdg θ: ±0.03°	Z: ±0.05% rdg θ: ±0.03°
Measurement frequency	1 mHz to 200 kHz (5 digits setting resolution, minimum resolution 1 mHz)	1 mHz to 200 kHz (5 digits setting resolution, minimum resolution 1 mHz)
Measurement signal level	[Normal mode] V mode, CV mode: 5 mV to 5 Vrms, 1 mVrms steps CC mode: 10 μA to 50 mArms, 10 μArms steps [Low impedance high accuracy mode] V mode, CV mode: 5 mV to 2.5 Vrms, 1 mVrms steps CC mode: 10 μA to 100 mArms, 10 μArms steps	[Normal mode] V mode, CV mode: 5 mV to 5 Vrms, 1 mVrms steps CC mode: 10 μA to 50 mArms, 10 μArms steps [Low impedance high accuracy mode] V mode, CV mode: 5 mV to 2.5 Vrms, 1 mVrms steps CC mode: 10 μA to 100 mArms, 10 μArms steps
Output impedance	Normal mode: 100 Ω, Low impedance high accuracy mode: 25 Ω	Normal mode: 100 Ω, Low impedance high accuracy mode: 25 Ω
Display	5.7-inch touch-screen color TFT, display can be set to ON/OFF	5.7-inch touch-screen color TFT, display can be set to ON/OFF
Measurement time	2 ms (1 kHz, FAST, display OFF, representative value)	2 ms (1 kHz, FAST, display OFF, representative value)
Functions	DC bias measurement, DC resistance temperature compensation (converted reference temperature display), Comparator, BIN measurement (classify function), Panel loading/saving, Memory function	DC bias measurement, DC resistance temperature compensation (converted reference temperature display), Comparator, BIN measurement (classify function), Panel loading/saving, Memory function
Interfaces	EXT I/O (Handler), USB communication (high-speed), USB memory Optional: Choose 1 from RS-232C, GP-IB, or LAN	EXT I/O (Handler), USB communication (high-speed), USB memory Optional: Choose 1 from RS-232C, GP-IB, or LAN
Power supply	100 to 240 V AC, 50/60 Hz, 50 VA max	100 to 240 V AC, 50/60 Hz, 50 VA max
Dimensions and mass	330 mm (12.99 in) W × 119 mm (4.69 in) H × 168 mm (6.61 in) D, 3.1 kg (109.3 oz)	330 mm (12.99 in) W × 119 mm (4.69 in) H × 168 mm (6.61 in) D, 3.1 kg (109.3 oz)
Included accessories	Power cord ×1, Instruction manual ×1, CD-R (includes PC commands and sample software) ×1	Power cord ×1, Instruction manual ×1, CD-R (includes PC commands and sample software) ×1

LCR Meters

#### IM3590, IM3533, IM3523 shared options

Please see shared options for model IM3590

## Compact & Powerful Dedicated LCR Measurement in 5 msec Timeframes

### LCR HiTESTER 3511-50



- GP-IB** option
- RS-232C** option
- CE**
- 3 Year Warranty**

- High speed measurement: 5 ms (1 kHz) or 13 ms (120 Hz)
- Built-in high-speed comparator
- Measurement frequency: 1 kHz/120 Hz selectable
- From minute measurement with a maximum resolution of 0.001 pF (depending on measurement frequency) to high-capacity measurement up to 1 F

Model No. (Order Code) **3511-50** (Measurement frequencies: 120 Hz and 1 kHz)

*This product is not supplied with measurement probes or test fixtures. Please select and purchase the measurement probe or test fixture options appropriate for your application separately. For an RS-232C connection: A crossover cable for interconnection can be used. You can use the RS-232C CABLE 9637 without hardware flow control.*

#### Basic specifications (Accuracy guaranteed for 6 months)

Measurement parameters	Z , θ, R, C, L, D (tanδ), Q
Measurement range	Z , R: 10 mΩ to 200.00 MΩ θ: -90.00° to +90.00° C (at 120 Hz): 9.40 pF to 999.99 mF, C (at 1 kHz): 0.940 pF to 99.999 mF L (at 120 Hz): 14.00 μH to 200.00 kH, L (at 1 kHz): 1.600 μH to 20.000 kH D: 0.0001 to 1.9900, Q: 0.85 to 999.99
Basic accuracy	Z : ±0.08 % rdg θ: ±0.05°
Measurement frequency	120 Hz or 1 kHz
Measurement signal level	50 mV, 500 mV, 1 V rms
Output impedance	50 Ω
Display	LED (5-digit display, full-scale count depends on range)
Measurement time	Fast: 13 msec, Normal: 90 msec, Slow: 400 msec. (at 120 Hz) Fast: 5 msec, Normal: 60 msec, Slow: 300 msec. (at 1 kHz)
DC bias	DC voltage/DC current can be superimposed on the measurement signal. (Requires optional unit and external constant voltage source/constant current source.)
Functions	Panel save and load function, Comparator, External input/Output (EXT. I/O), GP-IB (option) or RS-232C interface
Power supply	Selectable 100, 120, 220 or 240V AC ±10%, 50/60Hz, 20VA max.
Dimensions and mass	210 mm (8.27 in)W × 100 mm (3.94 in)H × 168 mm (6.61 in)D, 2.5 kg (88.2 oz)
Included accessories	Instruction manual ×1, Power cord ×1, Spare fuse ×1

**SMD TEST FIXTURE IM9110**  
Direct connection two-terminal measurement type for measuring SMDs, DC to 1 MHz, measurable sample sizes: 0.08004 (inch)

**SMD TEST FIXTURE IM9100**  
Direct connection type. For measuring SMDs with electrodes on the bottom, DC to 8 MHz, measurable sample sizes: 01005 to 0402 (inch), 0402 to 1005 (metric)

**PINCHER PROBE L2001**  
Cable length 73 cm (28.74 ft), DC to 8 MHz, impedance characteristics of 50 Ω, 4-terminal pair configuration, tip electrode spacing: 0.3 (0.01 in) to 6 mm (0.24 in)

**CONTACT TIPS IM9901**  
To replace the tip on the L2001, regular size, bundled with the L2001

**CONTACT TIPS IM9902**  
To replace the tip on the L2001, small size

**SMD TEST FIXTURE 9699**  
Direct connection type. For measuring SMDs with electrodes on the bottom, DC to 120 MHz, test sample dimensions: 1.0 mm (0.04 in) to 4.0 mm (0.16 in) wide, max. 1.5 mm (0.06 in) high

**SMD TEST FIXTURE 9677**  
Direct connection type. For measuring SMDs with electrodes on the side, DC to 120 MHz, test sample dimensions: 3.5 mm ±0.5 mm (0.14 in ±0.02 in)

**SMD TEST FIXTURE 9263**  
Direct connection type, DC to 8 MHz, test sample dimensions: 1 mm (0.04 in) to 10 mm (0.39 in)

**TEST FIXTURE 9262**  
Direct connection type, DC to 8 MHz, measurable conductor diameter: ø0.3 (0.01 in) to 2 mm (0.08 in)

**TEST FIXTURE 9261**  
DC to 8 MHz, 1 m (3.28 ft) length, impedance characteristics of 75 Ω

**4-TERMINAL PROBE 9140**  
DC to 100 kHz, 1 m (3.28 ft) length, impedance characteristics of 75 Ω

**DC BIAS CURRENT UNIT 9269**  
42 Hz to 100 kHz, Max. allowable current: ±2A DC

**DC BIAS VOLTAGE UNIT 9268**  
42 Hz to 5 MHz, Max. allowable voltage: ±40 V DC

**CONNECTION CORD 9166**  
Metal BNC to clip, 1.5 m (4.92 ft) length

**CONNECTION CORD 9165**  
Cord has metallic BNC connectors at both ends, use at metallic terminal, 1.5 m (4.92 ft) length

**GP-IB CONNECTOR CABLE 9151-02**  
2 m (6.56 ft) length

**Discontinuation scheduled**  
**GP-IB INTERFACE 9518-01**  
Built into rear panel

Note: The 9268-01 cannot be used with the 3511-50, use with the 9268/9269, Not CE marked

## High-speed 1MHz C Tester Delivering Super Precise Measurements Even from Low Capacitance Levels

### C METER 3506-10



GP-IB

RS-232C



- High-speed analog test time of 0.6 ms (at 1 MHz)
- Improved noise resistance and enhanced repeatability in measurement precision even for production lines
- 1 kHz and 1 MHz measurement frequency supports stable low capacitance testing with taping machines
- BIN function, for easy component screening

Model No. (Order Code) **3506-10** (Measurement frequencies: 1 kHz and 1 MHz)

This product is not supplied with measurement probes or test fixtures. Please select and purchase the measurement probe or test fixture options appropriate for your application separately. For an RS-232C connection: A crossover cable for interconnection can be used. You can use the RS-232C cable 9637 without hardware flow control.

#### Basic specifications (Accuracy guaranteed for 1 year)

Measurement parameters	C (Capacitance), D (loss coefficient, tan δ), Q (1/tan δ)
Measurement range	C: 0.001 fF to 15.0000 μF, D: 0.00001 to 1.99999, Q: 0 to 19999.9
Basic accuracy	(Typ.) C: ±0.14 % rdg, D: ±0.0013
Measurement frequency	1 kHz, 1 MHz
Measurement signal level	500 mV, 1 V rms
Output impedance	1 Ω (at 1 kHz in 2.2 μF and higher ranges), 20 Ω (in ranges other than the above)
Display	LED (six digits, full scale count depends on measurement range)
Measurement time	1.5 ms: 1 MHz, 2.0 ms: 1 kHz (Typ. value. Depends on measurement configuration settings)
Functions	BIN (measurement values can be classified by rank), Trigger-synchronous output, Setting configurations can be stored, Comparator, Averaging, Low-C reject (bad contact detection), Chatter detection, Current detection circuit monitoring, Applied voltage value monitoring, EXT. I/O, RS-232C, GP-IB
Power supply	Selectable from 100, 120, 220 or 240 V AC ±10 %, 50/60 Hz 40 VA max.
Dimensions and mass	260 mm (10.24 in) W × 100 mm (3.94 in) H × 298 mm (11.73 in) D, 4.8 kg (10.6 lb)
Included accessories	Power cord ×1, Instruction manual ×1, Spare fuse ×1

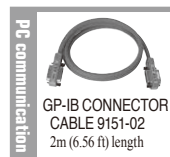

Probe and Test fixtures

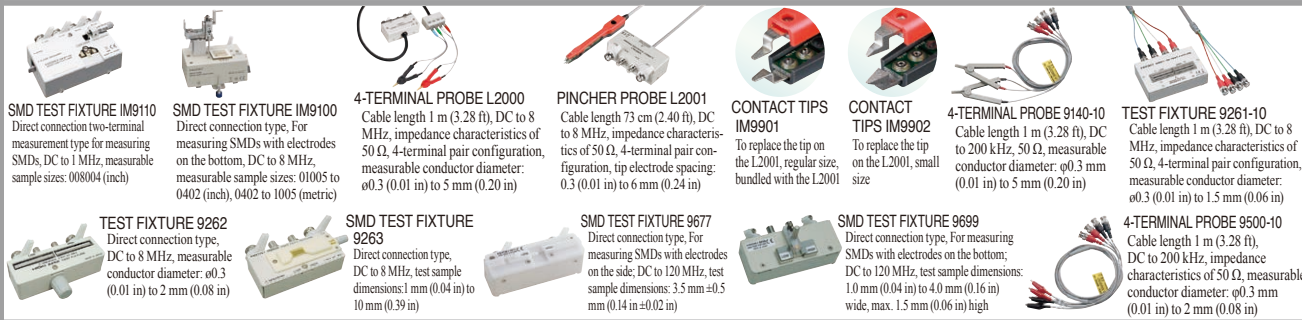

**SMD TEST FIXTURE IM9110**  
Direct connection two-terminal measurement type for measuring SMDs, DC to 1 MHz, measurable sample sizes: 008004 (inch)

**SMD TEST FIXTURE IM9100**  
Direct connection type, For measuring SMDs with electrodes on the bottom, DC to 8 MHz, measurable sample sizes: 01005 to 0402 (inch), 0402 to 1005 (metric)

**4-TERMINAL PROBE L2000**  
Cable length 1 m (3.28 ft), DC to 8 MHz, impedance characteristics of 50 Ω, 4-terminal pair configuration, measurable conductor diameter: ø0.3 (0.01 in) to 5 mm (0.20 in)

**PINCHER PROBE L2001**  
Cable length 73 cm (2.40 ft), DC to 8 MHz, impedance characteristics of 50 Ω, 4-terminal pair configuration, tip electrode spacing: 0.3 (0.01 in) to 6 mm (0.24 in)

**CONTACT TIPS IM9901**  
To replace the tip on the L2001, regular size, bundled with the L2001

**CONTACT TIPS IM9902**  
To replace the tip on the L2001, small size

**4-TERMINAL PROBE 9140-10**  
Cable length 1 m (3.28 ft), DC to 200 kHz, 50 Ω, measurable conductor diameter: ø0.3 mm (0.01 in) to 5 mm (0.20 in)

**TEST FIXTURE 9261-10**  
Cable length 1 m (3.28 ft), DC to 8 MHz, impedance characteristics of 50 Ω, 4-terminal pair configuration, measurable conductor diameter: ø0.3 (0.01 in) to 1.5 mm (0.06 in)

**TEST FIXTURE 9262**  
Direct connection type, DC to 8 MHz, measurable conductor diameter: ø0.3 (0.01 in) to 2 mm (0.08 in)

**SMD TEST FIXTURE 9263**  
Direct connection type, DC to 8 MHz, test sample dimensions: 1 mm (0.04 in) to 10 mm (0.39 in)

**SMD TEST FIXTURE 9677**  
Direct connection type, For measuring SMDs with electrodes on the side, DC to 120 MHz, test sample dimensions: 3.5 mm ±0.5 mm (0.14 in ±0.02 in)

**SMD TEST FIXTURE 9699**  
Direct connection type, For measuring SMDs with electrodes on the bottom, DC to 120 MHz, test sample dimensions: 1.0 mm (0.04 in) to 4.0 mm (0.16 in) wide, max. 1.5 mm (0.06 in) high

**4-TERMINAL PROBE 9500-10**  
Cable length 1 m (3.28 ft), DC to 200 kHz, impedance characteristics of 50 Ω, measurable conductor diameter: ø0.3 mm (0.01 in) to 2 mm (0.08 in)

## High-speed, Large-capacitance MLCC Inspection with Constant Voltage

### C HITESTER 3504



GP-IB

RS-232C



- High speed measurement of 2ms
- Supports C measurements with voltage dependency characteristics through the use of constant voltage testing (CV)
- Model 3504-60 can detect contact failure on all 4 terminals for increased reliability
- BIN function on the 3504-60/-50 is ideal for sorting machines
- Model 3504-40 offers high speed and affordability, perfect for integrating into taping machines
- In all models, contact error is constantly monitored during measurement, contributing to increased yield

Model No. (Order Code) **3504-40** (Built-in RS-232C interface)

**3504-50** (Built-in GP-IB, RS-232C)

**3504-60** (Built-in GP-IB, RS-232C)

This product is not supplied with measurement probes or test fixtures. Please select and purchase the measurement probe or test fixture options appropriate for your application separately. For an RS-232C connection: A crossover cable for interconnection can be used. You can use the RS-232C CABLE 9637 without hardware flow control.

#### Basic specifications (Accuracy guaranteed for 6 months)

Measurement parameters	C (capacitance), D (loss coefficient tan δ)
Measurement range	C: 0.9400 pF to 20.0000 mF, D: 0.00001 to 1.99999
Basic accuracy	(Typ.) C: ±0.09 % rdg ±10 dgt, D: ±0.0016
Measurement frequency	120 Hz, 1 kHz
Measurement signal level	100 mV (3504-60 only), 500 mV, 1 V rms CV 100 mV Measurement range: up to 170 μF range (Source frequency 1 kHz), up to 1.45 mF range (Source frequency 120 Hz) CV 500 mV Measurement range: up to 170 μF range (Source frequency 1 kHz), up to 1.45 mF range (Source frequency 120 Hz) CV 1V Measurement range: up to 70 μF range (Source frequency 1 kHz), up to 700 μF range (Source frequency 120 Hz)
Output impedance	5Ω (In open terminal voltage mode outside of the CV measurement range)
Display	LED (six digits, full scale count depends on measurement range)
Measurement time	2 ms (Typ. value. Depends on measurement configuration settings)
Functions	4-terminal contact check function (3504-60 only) BIN (measurement values can be classified by rank) (3504-50, 3504-60), Trigger-synchronous output, Setting configurations can be stored, Comparator, Averaging, Low-C reject (bad contact detection), Chatter detection, EXT. I/O, RS-232C GP-IB (3504-50, 3504-60)
Power supply	Selectable from 100, 120, 220 or 240 V AC ±10 %, 50/60 Hz, 110 VA max.
Dimensions and mass	260 mm (10.24 in)W × 100 mm (3.94 in)H × 220 mm (8.66 in)D, 3.8 kg (8.38 lb)
Included accessories	Power cord ×1, Instruction manual ×1, Spare fuse ×1



Probe and Test fixtures

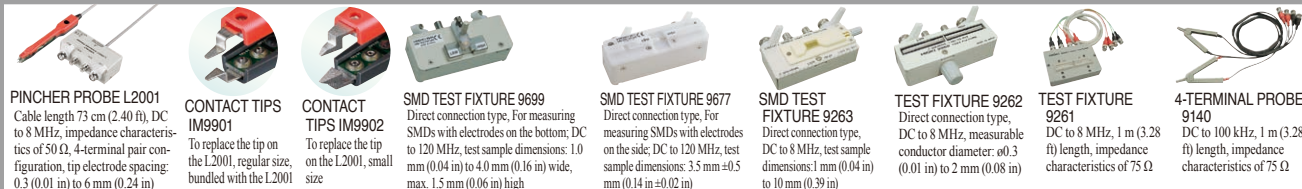

**PINCHER PROBE L2001**  
Cable length 73 cm (2.40 ft), DC to 8 MHz, impedance characteristics of 50 Ω, 4-terminal pair configuration, tip electrode spacing: 0.3 (0.01 in) to 6 mm (0.24 in)

**CONTACT TIPS IM9901**  
To replace the tip on the L2001, regular size, bundled with the L2001

**CONTACT TIPS IM9902**  
To replace the tip on the L2001, small size

**SMD TEST FIXTURE 9699**  
Direct connection type, For measuring SMDs with electrodes on the bottom, DC to 120 MHz, test sample dimensions: 1.0 mm (0.04 in) to 4.0 mm (0.16 in) wide, max. 1.5 mm (0.06 in) high

**SMD TEST FIXTURE 9677**  
Direct connection type, For measuring SMDs with electrodes on the side, DC to 120 MHz, test sample dimensions: 3.5 mm ±0.5 mm (0.14 in ±0.02 in)

**SMD TEST FIXTURE 9263**  
Direct connection type, DC to 8 MHz, test sample dimensions: 1 mm (0.04 in) to 10 mm (0.39 in)

**TEST FIXTURE 9262**  
Direct connection type, DC to 8 MHz, measurable conductor diameter: ø0.3 (0.01 in) to 2 mm (0.08 in)

**TEST FIXTURE 9261**  
DC to 8 MHz, 1 m (3.28 ft) length, impedance characteristics of 75 Ω

**4-TERMINAL PROBE 9140**  
DC to 100 kHz, 1 m (3.28 ft) length, impedance characteristics of 75 Ω



## For LCR Meters and Impedance Analyzers Probes & Test Fixtures and Applicable SMD size

Please use the probes specified below. For probe characteristic impedance of 50 Ω, a 50 Ω coaxial cable is used. For probe characteristic impedance of 75 Ω, a 75 Ω coaxial cable is used.

### Probes and Test Fixtures for Lead Components



**FOUR-TERMINAL PROBE L2000**  
Cable length 1 m (3.28 ft), DC to 8 MHz, impedance characteristics of 50 Ω, 4-terminal pair configuration, measurable conductor diameter: φ0.3 (0.01 in) to 5 mm (0.20 in)

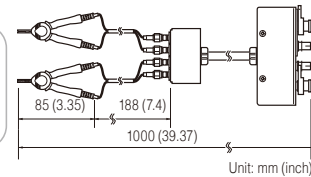
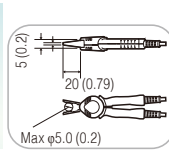

**4-TERMINAL PROBE 9140-10**  
Cable length 1 m (3.28 ft), DC to 200 kHz, impedance characteristics of 50 Ω, 4-terminal pair configuration, measurable conductor diameter: φ0.3 (0.01 in) to 5 mm (0.20 in)

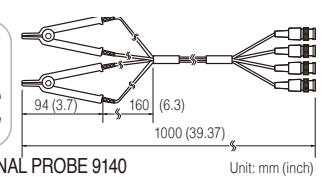
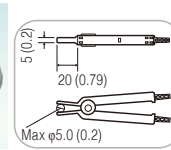

**4-TERMINAL PROBE 9140**  
Cable length 1 m (3.28 ft), DC to 100 kHz, impedance characteristics of 75 Ω, 4-terminal configuration, measurable conductor diameter: φ0.3 (0.01 in) to 5 mm (0.20 in)



**TEST FIXTURE 9261-10**  
Cable length 1 m (3.28 ft), DC to 8 MHz, impedance characteristics of 50 Ω, 4-terminal pair configuration, measurable conductor diameter: φ0.3 (0.01 in) to 1.5 mm (0.06 in)



**TEST FIXTURE 9261**  
Impedance characteristics of 75 Ω, 4-terminal configuration, Other specifications are the same as for the 9261-10



**TEST FIXTURE 9262**  
Direct connection type, DC to 8 MHz, measurable conductor diameter: φ0.3 (0.01 in) to 2 mm (0.08 in)

### Test Fixtures for SMDs

#### Applicable SMD size

✓ : Measurable  
▲ : Not recommended

SMD type	Length: L	Width: W	IM9202	IM9201	IM9110	IM9100	L2001 with tip IM9901	L2001 with tip IM9902	9699	9677	9263
0201	0.25 mm (0.01 in)	0.125 mm (0.005 in)			✓						
0402	0.40 mm (0.02 in)	0.20 mm (0.01 in)				✓					
0603	0.60 mm (0.02 in)	0.30 mm (0.01 in)		✓		✓		✓		▲	
1005	1.00 mm (0.04 in)	0.50 mm (0.02 in)		✓		✓		✓		✓	
1608	1.60 mm (0.06 in)	0.80 mm (0.03 in)	✓	✓			✓	✓	✓	✓	▲
2012	2.00 mm (0.08 in)	1.25 mm (0.05 in)	✓	✓			✓	✓	✓	▲	✓
3216	3.20 mm (0.13 in)	1.60 mm (0.06 in)	✓	✓			✓	✓	▲		✓
3225	3.20 mm (0.13 in)	2.50 mm (0.10 in)	✓	✓			✓	✓	▲		✓
4532	4.50 mm (0.18 in)	3.20 mm (0.13 in)	✓				✓	✓			✓
5750	5.70 mm (0.22 in)	5.00 mm (0.20 in)	✓				✓	✓			✓

#### Use in combination



**TEST FIXTURE STAND IM9200**  
Includes magnifying glass



**TEST FIXTURE IM9202**  
Use in combination with the IM9200



**SMD TEST FIXTURE IM9201**  
Use in combination with the IM9200



**ADAPTER(3.5mm/7mm) IM9906**  
3.5 mm (0.14 in) male to 7 mm (0.28 in) conversion



**CALIBRATION KIT IM9905**  
Open/Short/Load set



**SMD TEST FIXTURE IM9110**  
Direct connection two-terminal measurement type for measuring SMDs, DC to 1 MHz, measurable sample sizes: 008004 (inch)

#### Probe contact

Advanced contact technology delivers highly reproducible measurement results.

Measurement probe diameter: φ 0.155 mm

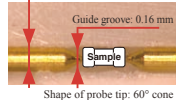

**SMD TEST FIXTURE IM9100**  
Direct connection type, SMDs with electrodes on the bottom, DC to 8 MHz, Measurable sample sizes: 01005 to 0402 (inch)

#### SMD positioning mechanism

Test pieces can be positioned easily and reliably using templates and guide grooves for various SMD sizes.

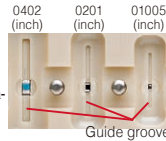

#### High-precision four-terminal measurement

The fixture uses stable, high-precision four-terminal measurement to reliably apply four probes to the SMD's small electrodes.



**SMD TEST FIXTURE 9699**  
Direct connection type, For measuring SMDs with electrodes on the bottom; DC to 120 MHz, test sample dimensions: 1.0 mm (0.04 in) to 4.0 mm (0.16 in) wide, max. 1.5 mm (0.06 in) high

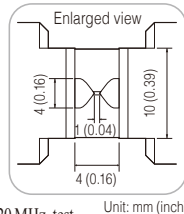

**SMD TEST FIXTURE 9677**  
Direct connection type, For measuring SMDs with electrodes on the side; DC to 120 MHz, test sample dimensions: 3.5 mm ±0.5 mm (0.14 in ±0.02 in)

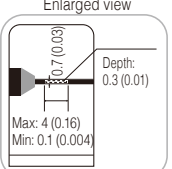

**SMD TEST FIXTURE 9263**  
Direct connection type, DC to 8 MHz, Test sample dimensions: 1 mm (0.04 in) to 10 mm (0.39 in)

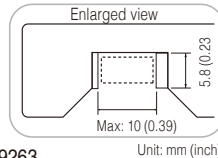

**PINCHER PROBE L2001**  
Cable length 73 cm (2.40 ft), DC to 8 MHz, impedance characteristics of 50 Ω, 4-terminal pair configuration, tip electrode spacing: 0.3 (0.01 in) to 6 mm (0.24 in)



**CONTACT TIPS IM9901**  
To replace the tip on the L2001, regular size, bundled with the L2001



**CONTACT TIPS IM9902**  
To replace the tip on the L2001, small size

## High-precision Portable Resistance Meter Measures from $\mu\Omega$ to $M\Omega$

### RESISTANCE METER RM3548



USB 2.0

CE

3 Year Warranty

#### Basic specifications (Accuracy guaranteed for 1 year)

Resistance range	3 m $\Omega$ (3.5000 m $\Omega$ display max., 0.1 $\mu\Omega$ resolution) to 3 M $\Omega$ range (3.5000 M $\Omega$ display max., 100 $\mu\Omega$ resolution), 10 steps Measurement accuracy: $\pm 0.020\%$ rdg $\pm 0.007\%$ f.s.
Testing current	[at 3 m $\Omega$ range] 1 A DC to [at 3 M $\Omega$ range] 500 nA DC
Open-terminal voltage	5.5 V DC max.
Temperature measurement	-10.0°C to 99.9°C, accuracy: $\pm 0.5^\circ\text{C}$ (Temperature Sensor Z2002 and RM3548 combined accuracy)
Measurement speed	Fixed
Display refresh rate	Without OVC: approx. 100ms, With OVC: approx. 230ms
Functions	Temperature correction, temperature conversion, offset voltage compensation (OVC), comparator (ABS/REF%), length conversion, judgment sound setting, auto hold, auto power save (APS), Averaging, panel store/panel load, USB communication interface (RM3548 internal memory is recognized as a mass storage device when connected to a PC)
Memory storage	Number of recordable data points: (manual/auto) Up to 1,000, (interval) Up to 6,000; Interval: 0.2s to 10.0s (0.2s steps); Acquisition of data from memory: display, USB mass storage (CSV, TXT files)
Power supply	LR6 (AA) Alkaline batteries $\times 8$ , Continuous use: 10 hours (Under our company's conditions), Rated power consumption: 5 VA max.
Dimensions and mass	192 mm (7.56 in) W $\times$ 121 mm (4.76 in) H $\times$ 55 mm (2.17 in) D, 770 g (27.2 oz)
Included accessories	Clip type lead L2107 $\times 1$ , Temperature sensor Z2002 $\times 1$ , LR6 Alkaline battery $\times 8$ , Instruction manual $\times 1$ , USB Cable (A-to-mini B type) $\times 1$ , Strap $\times 1$ , Spare fuse $\times 1$

- 0.02 % basic accuracy, 0.1  $\mu\Omega$  max. resolution, 1A max. testing current
- Measure from 0.0  $\mu\Omega$  (testing current 1 A) to 3.5 M $\Omega$
- Easily record up to 1,000 data points in memory simply by applying the instrument's probes
- Smoothly capture temperature-rise test data using interval measurement
- Portable design is ideal for maintenance and testing of large equipment

Model No. (Order Code) **RM3548**

\*The L2107, Z2002 are bundled with the RM3548

**CLIP TYPE LEADS L2107**  
A: 130 mm (5.12 in), B: 84 mm (3.31 in), L: 1.1 m (3.61 ft), 60 V DC

**FOUR TERMINAL LEAD 9453**  
A: 280 mm (11.02 in), B: 118 mm (4.65 in), L: 1.36 m (4.46 ft), 60 V DC

**PIN TYPE LEAD 9465-10**  
A: (red) 100 mm (3.94 in), (black) Max. 550 mm (21.65 in), B: 121 mm (4.76 in), L: 1883 mm (6.18 ft)

**TIP PIN 9465-90**  
To replace the tip on the 9465-10, (one piece)

**PIN TYPE LEAD 9772**  
A: (red) 100 mm (3.94 in), (black) Max. 550 mm (21.65 in), B: 118 mm (4.65 in), L: 1880 mm (6.17 ft)

**TIP PIN 9772-90**  
To replace the tip on the 9772, L2100, (one piece)

**LARGE CLIP TYPE LEAD 9467**  
A: 300 mm (11.81 in), B: 131 mm (5.16 in), L: 1310 mm (4.30 ft), tip  $\phi$  28 mm (1.10 in), 50 V DC

**TEMPERATURE SENSOR Z2002**  
100 mm (3.94 in) length

**LED COMPARATOR ATTACHMENT L2105**  
2 m (6.56 ft) length

**ZERO ADJUSTMENT BOARD 9454**  
For the L2100, 9465-10, 9465, 9461

**About lead length**

A: From junction to probe  
B: Probe length  
L: Overall length

Note: For L2107, length "A" can be extended by roughly 0.8 m (2.62 ft) by cutting the binding tube. Length "A" for all other leads cannot be extended.

**CARRYING CASE C1006**  
For the RM3548

## Featuring Super-high Accuracy and Multi-channel Capabilities (20 channels with 4-terminal measurement)

### RESISTANCE METER RM3545



GP-IB  
RM3545-01

RS-232C

USB 2.0

CE

3 Year Warranty

#### Basic specifications (Accuracy guaranteed for 1 year)

Resistance range	10 m $\Omega$ (12.00000 m $\Omega$ display max., 10 n $\Omega$ resolution) to 1000 M $\Omega$ range (1200.0 M $\Omega$ display max., 100 k $\Omega$ resolution), 12 steps [LP ON] 1000 m $\Omega$ (1200.00 m $\Omega$ display max., 10 $\mu\Omega$ resolution) to 1000 $\Omega$ range (1200.00 $\Omega$ display max., 10 m $\Omega$ resolution), 4 steps Measurement accuracy: $\pm 0.006\%$ rdg $\pm 0.001\%$ f.s.
Testing current	1 A DC to 100 nA DC [LP ON] 1 mA to 5 $\mu\text{A}$ DC
Open-terminal voltage	20 V DC max. (10 k $\Omega$ range or more), 5.5 V DC max. (1000 $\Omega$ range or less) [LP ON] 20 mV DC max.
Temperature measurement	-10.0°C to 99.9 °C, accuracy: $\pm 0.5^\circ\text{C}$ (Temperature Sensor Z2001 and RM3545 combined accuracy), -99.9°C to 999.9°C (analog input)
Measurement speed	FAST (2.0ms) / MED (50Hz: 22ms, 60Hz: 19ms) / SLOW1 (102ms) / SLOW2 (202ms) * Measurement speed is different at each range, 2.0 ms is the fastest value
Functions	Temperature correction, temperature conversion, offset voltage compensation (OVC), comparator (ABS/ REF%), BIN, key-lock (OFF, menu lock, all lock), display digit count selection function (7- digit/ 6- digit/ 5- digit), automatic power supply frequency settings (AUTO/ 50Hz/ 60Hz), scaling, judgment sound setting, auto hold, averaging, statistical calculations, panel store/panel load, D/A output.
Multiplexer	[Only RM3545-02] Support unit: Z3003 (Install up to 2 units)
Communication interfaces	Select from GP-IB (RM3545-01 only), RS-232C, PRINTER (RS-232C), or USB. Remote function, communications monitor function, data output function, memory (50)
Power supply	100 V to 240 V AC, 50 Hz/60 Hz, Rated power consumption: 40 VA max.
Dimensions and mass	215 mm (8.46 in) W $\times$ 80 mm (3.15 in) H $\times$ 306.5 mm (12.07 in) D [RM3545/RM3545-01] 2.5 kg (88.2 oz), [RM3545-02] 3.2 kg (112.9 oz)
Included accessories	Power cord $\times 1$ , Clip type lead L2101 $\times 1$ , temperature sensor Z2001 $\times 1$ , Male EXT I/O connector $\times 1$ , Instruction manual $\times 1$ , Application disc $\times 1$ , USB cable (A-to-B type) $\times 1$ , Spare fuse $\times 1$

- 0.006% basic accuracy, 0.01  $\mu\Omega$  max. resolution, 1A max. testing current
- Measure from 0.00  $\mu\Omega$  (testing current 1 A) to 1200 M $\Omega$
- Multiplexer Unit Z3003 (option) provides 20-channels of 4-terminal measurements for a complete assessment of multi-point signals (RM3545-02 only)
- Low-power resistance measurement with an open voltage not exceeding 20 mV
- High-speed, comprehensive productivity support delivers decisions in as little as 2.0 ms from start to finish

Model No. (Order Code) **RM3545**

**RM3545-01** (Built-in GP-IB interface)  
**RM3545-02** (Support for the multiplexer unit)

\*The L2101, Z2001 are bundled with the RM3545 series

**CLIP TYPE LEAD L2101**  
A: 250 mm (9.84 in), B: 84 mm (3.31 in), L: 1.5 m (4.92 ft)

**TIP PIN 9770-90**  
Replacement tip for pin type lead 9770, L2102

**PIN TYPE LEAD L2102**  
A: 250 mm (9.84 in), B: 178 mm (7.01 in), L: 1.5 m (4.92 ft)

**TIP PIN 9771-90**  
Replacement tip for pin type lead 9771, L2103

**PIN TYPE LEAD L2103**  
A: 250 mm (9.84 in), B: 176 mm (6.93 in), L: 1.5 m (4.92 ft)

**4-TERMINAL LEAD L2104**  
A: 280 mm (11.02 in), B: 149 mm (5.87 in), L: 1.5 m (4.92 ft)

**FOUR-POINT ARRAY PROBE RM9010-01**  
A: 125 mm (4.93 in), B: 75.5 mm (2.99 in), L: 1.5 m (4.92 ft)

**FOUR-POINT ARRAY PROBE RM9010-02**  
A: 120 mm (4.72 in), B: 84 mm (3.31 in), L: 1.5 m (4.92 ft)

**TEMPERATURE SENSOR Z2001**  
1.75 m (5.74 ft) length  
Standard attachment to RM3545  
Optional for RM3544

**LED COMPARATOR ATTACHMENT L2105**  
2 m (6.56 ft) length

**About lead length**

A: From junction to probe  
B: Probe length  
L: Overall length

Note: For L2101 to L2104, length "A" can be extended by roughly 1.1 m (3.61 ft) by cutting the binding tube.

**MULTIPLEXER UNIT Z3003**  
4-wire 10ch or 2-wire 21ch input scanning

**RS-232C CABLE 9637**  
For the PC, 9-pin - 9-pin, cross, 1.8m (5.91 ft) length

**GP-IB CONNECTOR CABLE 9151-02**  
2m (6.56 ft) length

## Long-Selling Model for Low Resistance Measurement

### RESISTANCE METER RM3544



**USB<sub>2.0</sub>**  
RM3544-01  
**RS-232C**  
RM3544-01



**3 year**  
Warranty

- 0.02 % basic accuracy, 1  $\mu\Omega$  max. resolution, 300 mA max. measurable current
- Measure from 0.000 m $\Omega$  (testing current 300 mA) to 3.5 M $\Omega$
- Probe for guard jack use and increased measurement current yield an instrument that's more resistant to noise
- Optional LED COMPARATOR ATTACHMENT and high-volume judgment tones combine to ensure PASS/FAIL judgments are communicated reliably in the noisy environment of the production floor
- EXT I/O interface with NPN/PNP support can accommodate a variety of automated production lines (-01 model)

Model No. (Order Code) **RM3544** (No interfaces)  
**RM3544-01** (Built-in EXT I/O, RS-232C, USB)

#### Basic specifications (Accuracy guaranteed for 1 year)

Resistance range	30 m $\Omega$ (35,000 m $\Omega$ display max., 1 $\mu\Omega$ resolution) to 3 M $\Omega$ range (3.5000 M $\Omega$ display max., 100 $\Omega$ resolution), 9 steps Measurement accuracy: $\pm 0.020\%$ rdg $\pm 0.007\%$ f.s.
Testing current	[at 30 m $\Omega$ range] 300 mA DC to [at 3 M $\Omega$ range] 500 nA DC
Open-terminal voltage	5.5 V DC max.
Temperature measurement	-10.0 $^{\circ}$ C to 99.9 $^{\circ}$ C, accuracy: $\pm 0.5^{\circ}$ C (Temperature Sensor Z2001 and RM3544 combined accuracy)
Measurement speed	FAST (50Hz: 21ms, 60Hz: 18ms) / MED (101ms) / SLOW (401ms)
Display refresh rate	N/A
Functions	Temperature correction, comparator (ABS/REF%), key-lock (OFF, menu lock, all lock), display digit count selection function (5 digits/ 4 digits), automatic power supply frequency settings (AUTO/50Hz/60Hz), scaling, judgment sound setting, auto hold, averaging, panel store/panel load
Memory storage	N/A
Communication interfaces	[Only RM3544-01] Select from RS-232C, PRINTER (RS-232C), or USB Remote function, communications monitor function, data output function
Power supply	100 V to 240 V AC, 50 Hz/60 Hz, Rated power consumption: 15 VA max.
Dimensions and mass	215 mm (8.46 in) W $\times$ 80 mm (3.15 in) H $\times$ 166 mm (6.54 in) D [RM3544] 0.9 kg (31.7 oz), [RM3544-01] 1.0 kg (35.3 oz)
Included accessories	[RM3544] Power cord $\times$ 1, Clip type lead L2101 $\times$ 1, Instruction manual $\times$ 1, Spare fuse $\times$ 1 [RM3544-01] Power cord $\times$ 1, Clip type lead L2101 $\times$ 1, Male EXT I/O connector $\times$ 1, Instruction manual $\times$ 1, Application disc $\times$ 1, USB cable (A-to-B type) $\times$ 1, Spare fuse $\times$ 1

\*The L2101 is bundled with the RM3544 series

Measurement Leads / Input scanner

**CLIP TYPE LEAD L2101**  
A: 250 mm (9.84 in), B: 84 mm (3.31 in), L: 1.5 m (4.92 ft)

**TIP PIN 9770-90**  
Replacement tip for pin type lead 9770, L2102

**PIN TYPE LEAD L2102**  
A: 250 mm (9.84 in), B: 178 mm (7.01 in), L: 1.5 m (4.92 ft)

**TIP PIN 9771-90**  
Replacement tip for pin type lead 9771, L2103

**PIN TYPE LEAD L2103**  
A: 250 mm (9.84 in), B: 176 mm (6.93 in), L: 1.5 m (4.92 ft)

**4-TERMINAL LEAD L2104**  
A: 280 mm (11.02 in), B: 149 mm (5.87 in), L: 1.5 m (4.92 ft)

**TEMPERATURE SENSOR Z2001**  
1.75 m (5.74 ft) length

**LED COMPARATOR ATTACHMENT L2105**  
2 m (6.56 ft) length

**About lead length**

A: From junction to probe  
B: Probe length  
L: Overall length

Note: For L2101 to L2104, length "A" can be extended by roughly 1.1 m (3.61 ft) by cutting the binding tube.

**PC Communication**

**RS-232C CABLE 9637**  
For the PC, 9pin - 9pin, cross, 1.8m (5.91 ft) length

## Resistance Meter for Ultra-low and Low Shunt Resistance

### RESISTANCE HITESTER RM3543



**GP-IB**  
RM3543-01  
**RS-232C**



**3 year**  
Warranty

- Advanced enough to measure 0.1 m $\Omega$  shunts with room to spare at  $\pm 0.16\%$  accuracy & 0.01 $\mu\Omega$  resolution performance
- Superb repeatable measurement accuracy
- Advanced contact-check, comparator, and data export functions
- Intuitive user interface and strong noise immunity are ideal for automated systems

Model No. (Order Code) **RM3543**  
**RM3543-01** (Built-in GP-IB interface)

Test fixtures are not supplied with the unit. Select an optional test fixture when ordering.

#### Basic specifications (Accuracy guaranteed for 1 year)

Measurement method	Four-terminal, constant-current DC
Resistance range	10 m $\Omega$ (max. 12,000,000 m $\Omega$ , 0.01 $\mu\Omega$ resolution) to 1000 $\Omega$ range (max. 1200,000 $\Omega$ , 1 m $\Omega$ resolution), 6 steps
Display	Monochrome graphic LCD 240 $\times$ 64 dot, white LED backlight
Measurement accuracy	[at 10 m $\Omega$ range, with SLOW mode, average 16 times settings] $\pm 0.060\%$ rdg $\pm 0.001\%$ f.s.
Testing current	[at 10 m $\Omega$ range] 1 A DC to [at 1000 $\Omega$ range] 1 mA DC
Open-terminal voltage	20 V DC max. Note: Voltage when not measuring is 20 mV or less, with current mode set at PULSE and Contact Improver Setting set at OFF/PULSE (measured with a voltmeter having 10 M $\Omega$ )
Sampling rate	FAST, MEDIUM, SLOW, 3 settings
Integration time	[at 10 m $\Omega$ range, default value] FAST 2.0 ms, MED 5.0 ms, SLOW 1 PLC, Setting range: 0.1 ms to 100.0 ms, or 1 to 5 PLC at 50 Hz, 1 to 6 PLC at 60 Hz Note: PLC = one power line cycle (mains wave-form period)
Other functions	Comparator (compare setting value with measurement value), Delay, OVC (offset voltage compensation), Average, Measurement fault detection, Probe short-circuit detection, Improve contact, Current mode setting (A pulse application function that applies current only during measurement), Auto-memory, Statistical calculations, Settings monitor (when using two instruments, a difference in settings causes warning notification), Retry, Trigger function, etc.
Interfaces	External I/O, RS-232C, Printer (RS-232C), GP-IB (Model RM3543-01)
External I/O	Trigger, Hold input, Comparator output, Settings monitor terminal, Service power output +5V, +12V, etc.
Power supply	100 V to 240 V AC, 50 Hz/60 Hz, 40 VA max.
Dimensions and mass	260 mm (10.24 in) W $\times$ 88 mm (3.46 in) H $\times$ 300 mm (11.81 in) D, 3.0 kg (105.8 oz)
Included accessories	Power cord $\times$ 1, EXT I/O male connector $\times$ 1, Instruction manual $\times$ 1, Operation guide $\times$ 1

**4-TERMINAL PROBE 9500**  
DC to 1 MHz, 1 m (3.28 ft) length

**4-TERMINAL PROBE 9140**  
DC to 100 kHz, 1 m (3.28 ft) length, impedance characteristics of 75  $\Omega$

**TEST FIXTURE 9262**  
Direct connection type, DC to 8 MHz, measurable conductor diameter:  $\phi 0.3$  (0.01 in) to 2 mm (0.08 in)

**SMD TEST FIXTURE 9263**  
Direct connection type, DC to 8 MHz, Test sample dimensions: 1 mm (0.04 in) to 10 mm (0.39 in)

**PC communication**

**RS-232C CABLE 9637**  
For the PC, 9pin - 9pin, cross, 1.8m (5.91 ft) length

**GP-IB CONNECTOR CABLE 9151-02**  
2m (6.56 ft) length

# Resistance Meters

## High-Speed Resistance Meter Ideal for Automated Lines; Compatible with Super-Small Electronic Components

### RESISTANCE METER RM3542A



GP-IB  
RM3542-51  
RS-232C



#### Basic specifications (Accuracy guaranteed for 1 year)

Resistance range	[at Low Power OFF] 100 mΩ range (max. 120.0000 mΩ, 0.1 μΩ resolution) to 100 MΩ range (max. 120.0000 MΩ, 100 Ω resolution), 16 steps [at Low Power ON] 1000 mΩ range (max. 1200.000 mΩ, 1 μΩ resolution) to 1000 Ω range (max. 1200.000 Ω, 1 mΩ resolution), 6 steps
Display	Monochrome graphic LCD 240 × 64 dot, white LED backlight
Measurement accuracy	[with SLOW mode, at 100 mΩ range] ±0.015 % rdg ±0.002 % f.s. [with SLOW mode, at 1000 Ω range] ±0.006 % rdg ±0.001 % f.s. (best case)
Testing current	[at 100 mΩ range] 100 mA DC to [at 100 MΩ range] 100 nA DC
Open-terminal voltage	20 V DC max. (with applied voltage limit function enabled: 10 V DC max.)
Sampling rate	FAST, MEDIUM, SLOW, 3 settings
Measurement times	[at 100 Ω / 300 Ω / 1000 Ω ranges, with Low Power OFF] FAST: 0.9 ms, MED: 3.6 ms, SLOW: 17 ms (minimum time)
Integration time	0.1 ms to 100.0 ms, or 1 to 5 PLC at 50 Hz, 1 to 6 PLC at 60 Hz <i>Note: PLC = one power line cycle (mains wave-form period)</i>
Other functions	Comparator (compare setting value with measurement value), Delay (set to allow for mechanical delay of trigger input and probing, or set to allow for measurement object response), Applied Voltage Limit Function, Scaling Function, OVC (offset voltage compensation), Measurement fault detection, Probe short-circuit detection, Improve contact, Auto-memory, Statistical calculations, Settings monitor (when using two instruments, a difference in settings causes warning notification), Retry, Trigger function, Sample printing, etc.
Interfaces	RS-232C, Printer (RS-232C), GP-IB (Model RM3542-51)
External I/O	Trigger, Hold input, Comparator output, Settings monitor terminal
Power supply	100 V to 240 V AC, 50 Hz/60 Hz, 30 VA max.
Dimensions and mass	260 mm (10.24 in) W × 88 mm (3.46 in) H × 300 mm (11.81 in) D, 2.9 kg (102.3 oz)
Included accessories	Power cord ×1, EXT. I/O male connector ×1, Instruction manual ×1, Operation guide ×1

- Applied voltage limit function lets you switch the detection voltage to 5 V or less
- Contact improvement function suppresses rush current to aid in probing of super-small components
- Extensive selection of measurement ranges ensures the right detection voltage and delivers stable measurement
- Scaling function corrects for mounting state and test stage differences

Model No. (Order Code) **RM3542-50**  
**RM3542-51** (Built-in GP-IB interface)

Test fixtures are not supplied with the unit. Please select an optional test fixture when ordering.

Probe and Test fixtures



**SMD TEST FIXTURE IM9100**  
Direct connection type. For measuring SMDs with electrodes on the bottom. DC to 8 MHz. Measurable sample sizes: 01005 to 0402 (EIA), 0402 to 1005 (JIS)



**4-TERMINAL PROBE 9140-10**  
Cable length 1 m (3.28 ft). DC to 200 kHz, 50 Ω, measurable conductor diameter: ø0.3 mm (0.01 in) to 5 mm (0.20 in)



**TEST FIXTURE 9262**  
Direct connection type, DC to 8 MHz, measurable conductor diameter: ø0.3 (0.01 in) to 2 mm (0.08 in)



**SMD TEST FIXTURE 9263**  
Direct connection type, DC to 8 MHz, Test sample dimensions: 1 mm (0.04 in) to 10 mm (0.39 in)

PC communication



**RS-232C CABLE 9637**  
For the PC, 9pin - 9pin, cross, 1.8m (5.91 ft) length



**GP-IB CONNECTOR CABLE 9151-02**  
2m (6.56 ft) length

Other options: refer to the detailed catalog

## Measure in as Fast as 0.9 ms, Optimized for Automated Systems

### RESISTANCE METER HITESTER RM3542



GP-IB  
RM3542-01  
RS-232C



#### Basic specifications (Accuracy guaranteed for 1 year)

Resistance range	[at Low Power OFF] 100 mΩ range (max. 120.0000 mΩ, 0.1 μΩ resolution) to 100 MΩ range (max. 120.0000 MΩ, 100 Ω resolution), 10 steps [at Low Power ON] 1000 mΩ range (max. 1200.000 mΩ, 1 μΩ resolution) to 1000 Ω range (max. 1200.000 Ω, 1 mΩ resolution), 4 steps
Display	Monochrome graphic LCD 240 × 64 dot, white LED backlight
Measurement accuracy	[with SLOW mode, at 100 mΩ range] ±0.015 % rdg ±0.002 % f.s. [with SLOW mode, at 1000 Ω range] ±0.006 % rdg ±0.001 % f.s. (the best case)
Testing current	[at 100 mΩ range] 100 mA DC to [at 100 MΩ range] 100 nA DC
Open-terminal voltage	20 V DC max.
Sampling rate	FAST, MEDIUM, SLOW, 3 settings
Measurement times	[at 100 Ω / 1000 Ω ranges, with Low Power OFF] FAST: 0.9 ms, MED: 3.6 ms, SLOW: 17 ms (minimum time)
Integration time	0.1 ms to 100.0 ms, or 1 to 5 PLC at 50 Hz, 1 to 6 PLC at 60 Hz <i>Note: PLC = one power line cycle (mains wave-form period)</i>
Other functions	Comparator (compare setting value with measurement value), Delay (set to allow for mechanical delay of trigger input and probing, or set to allow for measurement object response), OVC (offset voltage compensation), Measurement fault detection, Probe short-circuit detection, Improve contact, Auto-memory, Statistical calculations, Settings monitor (when using two instruments, a difference in settings causes warning notification), Retry, Trigger function, etc.
Interfaces	RS-232C, Printer (RS-232C), GP-IB (Model RM3542-01)
External I/O	Trigger, Hold input, Comparator output, Settings monitor terminal
Power supply	100 V to 240 V AC, 50 Hz/60 Hz, 30 VA max.
Dimensions and mass	260 mm (10.24 in) W × 88 mm (3.46 in) H × 300 mm (11.81 in) D, 2.9 kg (102.3 oz)
Included accessories	Power cord ×1, EXT. I/O male connector ×1, Instruction manual ×1, Operation guide ×1

- High speed and accuracy maximize productivity in automated systems
- Multiple checking functions ensure proper contact for reliable measurements
- Low-power resistance mode measures chip inductors and EMC suppression components
- Supports sample inspections during the manufacturing process

Model No. (Order Code) **RM3542**  
**RM3542-01** (Built-in GP-IB interface)

Test fixtures are not supplied with the unit. Please select an optional test fixture when ordering.

Probe and Test fixtures



**4-TERMINAL PROBE 9140**  
DC to 100 kHz, 1 m (3.28 ft) length, impedance characteristics of 75 Ω



**TEST FIXTURE 9262**  
Direct connection type, DC to 8 MHz, measurable conductor diameter: ø0.3 (0.01 in) to 2 mm (0.08 in)



**SMD TEST FIXTURE 9263**  
Direct connection type, DC to 8 MHz, Test sample dimensions: 1 mm (0.04 in) to 10 mm (0.39 in)

PC communication



**RS-232C CABLE 9637**  
For the PC, 9pin - 9pin, cross, 1.8m (5.91 ft) length



**GP-IB CONNECTOR CABLE 9151-02**  
2m (6.56 ft) length

Other options: refer to the detailed catalog

## For estimating and approaching the ideal slurry internal state

### Slurry Analytical System

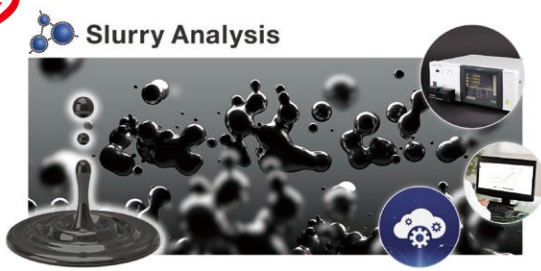

- A proprietary Hioki algorithm analyzes impedance measured values for LiB electrode slurries.
- Analysis Results "DCR, Rratio, Uniformity" indicate electron conductivity of Slurry.
- The latest version is available anytime by a Cloud-based, easy-to-use analysis tool.
- Able to choose license plan, fit the right solution for your needs.
- Easily measure the impedance of slurry in the measurement environment recommended by HIOKI.

Model No. (Order Code)	<b>SA2631-01</b>	(License card, the period of use is 3 consecutive days.)
	<b>SA2631-03</b>	(License card, the period of use is 30 consecutive days.)
	<b>SA2631-05</b>	(License card, the period of use is 365 consecutive days.)
	<b>SA9001</b>	(ELECTRODE CELL, sold in lots of 50.)
	<b>SA9002</b>	(SA9001 dedicated test fixture.)
	<b>IM3536</b>	(DC, or 4 Hz to 8 MHz)
	<b>IM3536-01</b>	(Special order product: DC, or 4 Hz to 10 MHz.)

\*Please purchase electrode cells and licenses as necessary based on your expected frequency of use and experimental plan.  
 \*Sensitive information will be shared with customers, including during use of analysis functionality.  
 Customers are responsible for determining whether to make purchases through a retailer.

#### Basic specifications (Electrode Cell SA9001)

Material	Container: polypropylene (PP), electrode: brass (nickel plated)
Capacity	Approx. 1 mL
Electrode pin	Diameter (Area where liquid to be measured comes in contact): 3 mm ±0.1 mm Electrode interval: 6 mm ±0.3 mm
Dimensions and mass	Approx. 27W × 42H × 37D mm (1.06"W × 1.65"H × 1.46"D) (including the electrode), approx. 2.3 g (0.1 oz.)

#### Basic specifications (Test Fixture SA9002)

Measurable frequency	DC to 10 MHz
Connectable sample	SA9001 Electrode Cell
Residual impedance	Residual resistance during short circuit 200 mΩ or less (reference for 100 Hz) Inter-electrode stray capacitance 0.2 pF or less (reference for 1 MHz)
Dimensions and mass	Approx. 98W × 38H × 24D mm (3.86"W × 1.50"H × 0.94"D) (excluding protruding parts), approx. 210 g (7.4 oz.)
Included accessory	Shorting plate for compensation

#### Measurement conditions\*

\*If using an instrument other than the IM3536 or IM3536-01 - Use the Electrode Cell SA9001. The analytical algorithm assumes use of the SA9001. - Check whether the Test Fixture SA9002 can be connected to the instrument. - Acquire data under the measurement conditions listed below. - Prepare a CSV file to send to the system.

Measurement parameters	Frequency, Rs (ReZ), X (ImZ)
Frequency sweep range	4 Hz (+3 Hz) to 10 MHz (-5 MHz)
Number of measurement points	Logarithmic interval, 500 points (±10 points)
Applied signal	Constant-voltage, ±100 mV

#### Available material categories

- The system uses the appropriate analytical algorithm to analyze the data based on the selected material category combination. - You may not be able to select some combinations, and some material categories may not be available. If you encounter this issue, perform the analysis using the default model. - There's no need to specify material proportions. - In some cases, the system may not be able perform analysis. - Hioki plans to add material categories over time.

Active materials	LCO, NMC, NCA, LMO, LFP, Graphite, LTO, Si, SiO, None
Conductive aid	Acetylene black, Carbon nanotube, Graphite
Binder	PVDF, SBR, None
Dispersant	CMC, MC, PVP, None
Solvent	NMP, Water

## Quantify Composite Layer Resistance and Interface Resistance in Li-ion Battery Electrode Sheets

### ELECTRODE RESISTANCE MEASUREMENT SYSTEM RM2610

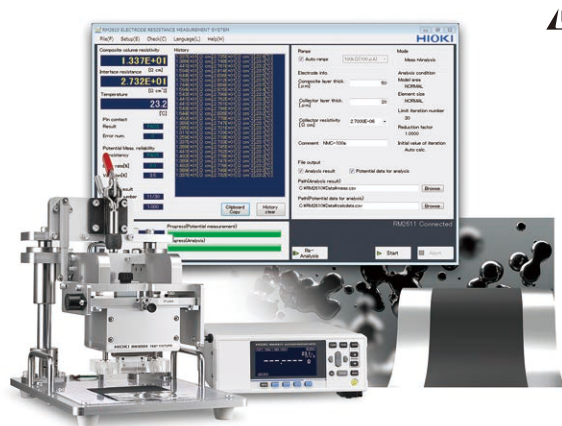

- Isolate and quantify composite layer resistance and interface resistance\* in positive- and negative-electrode sheets used in lithium-ion batteries.
- Composite layer resistance values and interface resistance\* values are helping LIBs to evolve and improve.

\*Contact resistance of current collector and material layer.

- Verify the uniformity of LIB electrode sheets.
- Visualize variations in composite layer resistance and interface resistance caused by differences in materials, composition, and manufacturing conditions.

Model No. (Order Code) **RM2610** (system product)

#### Basic specifications

Measurement target	Positive and negative electrode sheets for rechargeable lithium-ion batteries
Measurement parameters	Composite resistivity [ $\Omega\text{cm}$ ] Interface resistance (contact resistance) between the composite layer and current collector [ $\Omega\text{cm}^2$ ]
Computation method	Inverse problem analysis of potential distribution using the finite volume method
Information necessary for computation	• Composite layer thickness [ $\mu\text{m}$ ] (for 1 side) • Current collector thickness [ $\mu\text{m}$ ] • Current collector volume resistivity [ $\Omega\text{cm}$ ]
Measurement time	- Contact check + potential measurement : approx. 30 sec. - Calculation : approx. 35 sec. (on a PC with Intel core i5-7200U CPU) The measurement time may vary depending on the measurement target and the processing capacity of the PC.
Measurement current	1 $\mu\text{A}$ (min.) to 10 mA (max.)
Number of probes	46
Recommended PC specifications	CPU: 4 or more threads RAM: 8 GB or greater (4 GB required) Operating system: Windows 7 (64-bit), 8 (64-bit), 10 (64-bit)
Temperature measurement function	Measures temperature near the test fixture
Included accessories	TEMPERATURE SENSOR Z2001 ×1, USB cable ×1, USB license key ×1, Probe check board ×1, Power cord ×1, Instruction manual ×1

\*The RM2611 Electrode Resistance Meter requires regular calibration. For more information about calibration, please contact your HIOKI distributor



MAINTENANCE TOOL RM9006  
Maintenance kit for cleaning probes

## Packed with Features to Ensure Accuracy in Multi-channel Battery Testing

### SWITCH MAINFRAME SW1001, SW1002



LAN  
RS-232C  
USB 2.0  
CE  
3 Year Warranty

- Switch between voltmeter and battery tester while testing
- SW1001: max. 66 channels (2-wire) to max. 18 channels (4-terminal pair)
- SW1002: max. 264 channels (2-wire) to max. 72 channels (4-terminal pair)
- Circuit-design-friendly for impedance measurements that minimize errors between channels (Effect: 0.01% f.s.\*)

\* For BT4560 100 mΩ range, R measurements, and a measurement frequency of 1 kHz

- For OCV measurement, internal resistance measurement, and external potential measurement of battery cells
- Measure battery modules up to 60 V DC

Model No. (Order Code) **SW1001** (3 slots)  
**SW1002** (12 slots)

Note: Multiplexer Modules not included with the Switch Mainframe SW1001 / SW1002. Modules must be purchased separately.

#### Basic specifications

	SW1001	SW1002
Slots	3 slots	12 slots
Supported modules	MULTIPLEXER MODULE SW9001 (2-wire/4-wire) MULTIPLEXER MODULE SW9002 (4-terminal pair)	
Connectable instruments	Max. 2 units, 2-wire × 1 + 4-wire × 1, or 2-wire × 1 + 4-terminal pair × 1	
Max. input voltage	60 V DC (Cannot connect to battery packs in excess of 60 V DC), 30 V AC rms, 42.4 V peak, Maximum rated voltage to ground: 60 V DC	
Communication I/F	LAN, USB, RS-232C (for host, for measurement instruments)	
Functions	Channel switching, wiring method, scan function, communication command transmission, etc.	
Power supply	100 to 240 V AC / 30 VA (50/60 Hz)	
Dimensions and mass	215 mm (8.46 in) W × 132 mm (5.20 in) H × 420 mm (16.54 in) D, 3.7 kg (130.5 oz)	430 mm (16.93 in) W × 132 mm (5.20 in) H × 420 mm (16.54 in) D, 6.0 kg (211.6 oz)
Included accessories	Power cord × 1, instruction manual × 1, usage precautions × 1, USB driver CD × 1	

#### Basic specifications for MULTIPLEXER MODULE

	SW9001	SW9002
Wiring method	2-wire or 4-wire	4-terminal pair (6-wire) or 2-wire
No. of channels	22 channels (2-wire) / 11 channels (4-wire)	6 channels (4-terminal pair) / 6 channels (2-wire)
Contact method	Armature relays	
Channel switching time	11 ms (excluding measurement time)	
Max. allowable voltage	60 V DC, 30 V AC rms, 42.4 V peak	
Max. allowable current	1 A DC, 1 A AC rms	1 A DC, 1 A AC rms (Sense), 2 A DC, 2 A AC rms (Source, Return)
Max. allowable power	30 W (resistive load)	
Max. rated voltage to ground	60 V DC	
Dimensions and mass	25.5 mm (1.00 in) W × 110 mm (4.33 in) H × 257 mm (10.12 in) D, 210 g (7.4 oz)	25.5 mm (1.00 in) W × 110 mm (4.33 in) H × 257 mm (10.12 in) D, 196 g (6.9 oz)
Included accessories	Instruction manual × 1	

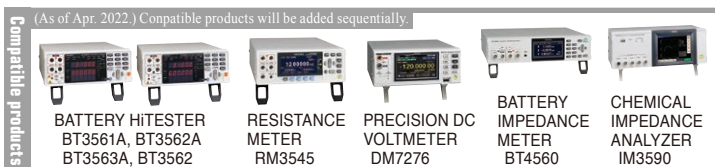
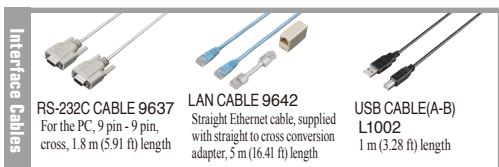
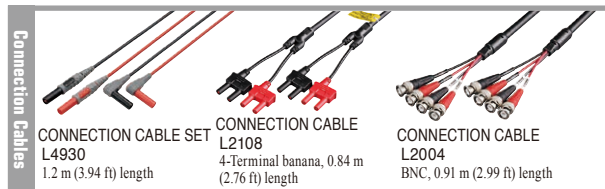
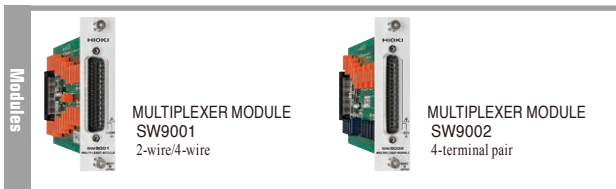

## Efficiently and Safely Validate Battery Management Systems

### BATTERY CELL VOLTAGE GENERATOR SS7081-50



- Build a highly accurate BMS\* validation environment easily and safely (\*BMS: Battery Management System)
- Use as voltage generator or simulated battery in place of actual batteries and power supplies to establish an efficient testing environment

Model No. (Order Code) **SS7081-50**

Control PC, control software, BMS wiring, etc., not included.

#### Basic specifications (Accuracy guaranteed for 1 year)

Number of channels	12 ch
Maximum in-series connections	In-series connections of instrument up to and including a maximum in-series output voltage of 1000 V
Output range	DC voltage: 0.0000 V to 5.0250 V (set independently for all channels) Maximum output current: ±1.00000 A (set independently for all channels)
Measurement range	DC voltage: -0.00100 V to 5.10000 V DC current (2-range architecture): ±1.20000 A (1 A range), ±120.0000 μA (100 μA range)
Integration time	1 PLC (50 Hz: 20 ms; 60 Hz: 16.7 ms) × number of smoothing iterations (user-configured)
Voltage output accuracy	±0.0150% of setting ±500 μV
Voltage measurement accuracy	±0.0100% of reading ±100 μV
Current measurement accuracy	1 A range: ±0.0700% of reading ±100 μA 100 μA range: ±0.0350% of reading ±10 nA
Interfaces	LAN
Power supply	Universal (100 V to 240 V AC), 50 Hz / 60 Hz
Dimensions and mass	430 (16.93 in) W × 132 (5.20 in) H × 483 (19.02 in) D, 10.3 kg (363.3 oz)
Included accessories	User manual × 1, power cord × 1, rack frame × 1, disk with computer application × 1 (Available within the range of application specifications)

# Battery Testers

## Fully automated production line testing of small cells for power motors or small packs of up to 60 V

### BATTERY HiTESTER BT3561A



LAN

RS-232C

CE

3 Year Warranty

- Simultaneous measurement of internal resistance and open circuit voltage
- Fully automated production line testing of small cells for power motors or small packs of up to 60 V
- Resistance measurement ranges: 30 mΩ/300 mΩ/3 Ω/30 Ω/300 Ω/3 kΩ
- Voltage measurement ranges: 6 V/60 V
- Equipped with LAN

Model No. (Order Code) **BT3561A**

Note: Measurement leads are not included. Purchase the appropriate lead option for your application separately. The male (system side) of the EXT I/O connector is also available. Please contact your authorized Hioki distributor or reseller.

#### Basic specifications (Accuracy guaranteed for 1 year)

Resistance measurement ranges	30 mΩ (Max. display: 31.000 mΩ, resolution: 1 μΩ, measurement current: 100 mA)
	300 mΩ (Max. display: 310.00 mΩ, resolution: 10 μΩ, measurement current: 10 mA)
Voltage measurement ranges	3 Ω (Max. display: 3.1000 Ω, resolution: 100 μΩ, measurement current: 1 mA)
	30 Ω (Max. display: 31.000 Ω, resolution: 1 mΩ, measurement current: 100 μA)
Response time	300 Ω (Max. display: 310.00 Ω, resolution: 10 mΩ, measurement current: 10 μA)
	3 kΩ (Max. display: 3.1000 kΩ, resolution: 100 mΩ, measurement current: 10 μA)
Sampling period	Basic accuracy: ±0.5% rdg ±5 dgt (±3 dgt. (EX.FAST), ±2 dgt. (FAST, MEDIUM) add.)
	Measurement frequency: 1 kHz ±0.2 Hz
Functions	Measurement method: AC four-terminal method
	6 V (Max. display: 6.00000 V, resolution: 10 μV)
Interfaces	60 V (Max. display: 60.0000 V, resolution: 100 μV)
	Basic accuracy: ±0.01% rdg. ±3 dgt. (±3 dgt. (EX.FAST), ±2 dgt. (FAST, MEDIUM) add.)
Power supply	10 ms
	Ω or V (60 Hz): 4 ms (EX.FAST), 12 ms (FAST), 35 ms (MEDIUM), 150 ms (SLOW)
Dimensions and mass	ΩV (60 Hz): 8 ms (EX.FAST), 24 ms (FAST), 70 ms (MEDIUM), 253 ms (SLOW)
	Ω or V (50 Hz): 4 ms (EX.FAST), 12 ms (FAST), 42 ms (MEDIUM), 157 ms (SLOW)
Included accessories	ΩV (50 Hz): 8 ms (EX.FAST), 24 ms (FAST), 84 ms (MEDIUM), 259 ms (SLOW)
	Contact check, Zero adjustment (±1000 counts), Pulse measurement, Comparator (Hi/IN/Lo), Statistical calculations (Max. 30,000), Delay, Average, Panel saving/loading, Memory storage, LabVIEW® driver
LAN (TCP/IP, 10BASE-T/100BASE-TX)	RS-232C (Max. 38.4 kbps, Available as printer I/F)
	EXT I/O (37-pin Handler interface)
Power supply	Analog output (DC 0 V to 3.1 V)
	100 to 240 V AC, 50 Hz/60 Hz, 35 VA max.
Dimensions and mass	215 mm (8.46 in) W × 80 mm (3.15 in) H × 295 mm (11.61 in) D, 2.4 kg (84.7 oz)
	Instruction manual ×1, Power cord ×1, Operating Precautions ×1

Battery Testers

## Fully Automated Production Line Testing of Large Cells for xEVs or Mid-sized Packs of up to 100 V

### BATTERY HiTESTER BT3562A



LAN

RS-232C

CE

3 Year Warranty

- Simultaneous measurement of internal resistance and open circuit voltage
- Fully automated production line testing of large cells for xEVs or mid-sized packs of up to 100 V
- Resistance measurement ranges: 3 mΩ/30 mΩ/300 mΩ/3 Ω/30 Ω/300 Ω/3 kΩ
- Voltage measurement ranges: 6 V/60 V/100 V
- Equipped with LAN

Model No. (Order Code) **BT3562A**

Note: Measurement leads are not included. Purchase the appropriate lead option for your application separately. The male (system side) of the EXT I/O connector is also available. Please contact your authorized Hioki distributor or reseller.

#### Basic specifications (Accuracy guaranteed for 1 year)

Resistance measurement ranges	3 mΩ (Max. display: 3.1000 mΩ, resolution: 0.1 μΩ, measurement current: 100 mA)
	30 mΩ (Max. display: 31.000 mΩ, resolution: 1 μΩ, measurement current: 100 mA)
Voltage measurement ranges	300 mΩ (Max. display: 310.00 mΩ, resolution: 10 μΩ, measurement current: 10 mA)
	3 Ω (Max. display: 3.1000 Ω, resolution: 100 μΩ, measurement current: 1 mA)
Response time	30 Ω (Max. display: 31.000 Ω, resolution: 1 mΩ, measurement current: 100 μA)
	300 Ω (Max. display: 310.00 Ω, resolution: 10 mΩ, measurement current: 10 μA)
Sampling period	3 kΩ (Max. display: 3.1000 kΩ, resolution: 100 mΩ, measurement current: 10 μA)
	Basic accuracy: ±0.5% rdg ±10 dgt (3 mΩ range: ±30 dgt. (EX.FAST), ±10 dgt. (FAST), ±5 dgt. (MEDIUM) add.)
Functions	±0.5% rdg ±5 dgt (30 mΩ range or more: ±3 dgt. (EX.FAST), ±2 dgt. (FAST, MEDIUM) add.)
	Measurement frequency: 1 kHz ±0.2 Hz
Interfaces	Measurement method: AC four-terminal method
	6 V (Max. display: 6.00000 V, resolution: 10 μV)
Power supply	60 V (Max. display: 60.0000 V, resolution: 100 μV)
	100 V (Max. display: 100.000 V, resolution: 1 mV)
Dimensions and mass	Basic accuracy: ±0.01% rdg. ±3 dgt. (±3 dgt. (EX.FAST), ±2 dgt. (FAST, MEDIUM) add.)
	10 ms
Included accessories	Ω or V (60 Hz): 4 ms (EX.FAST), 12 ms (FAST), 35 ms (MEDIUM), 150 ms (SLOW)
	ΩV (60 Hz): 8 ms (EX.FAST), 24 ms (FAST), 70 ms (MEDIUM), 253 ms (SLOW)
LAN (TCP/IP, 10BASE-T/100BASE-TX)	Ω or V (50 Hz): 4 ms (EX.FAST), 12 ms (FAST), 42 ms (MEDIUM), 157 ms (SLOW)
	ΩV (50 Hz): 8 ms (EX.FAST), 24 ms (FAST), 84 ms (MEDIUM), 259 ms (SLOW)
Power supply	Contact check, Zero adjustment (±1000 counts), Pulse measurement, Comparator (Hi/IN/Lo), Statistical calculations (Max. 30,000), Delay, Average, Panel saving/loading, Memory storage, LabVIEW® driver
	LAN (TCP/IP, 10BASE-T/100BASE-TX)
Dimensions and mass	RS-232C (Max. 38.4 kbps, Available as printer I/F)
	EXT I/O (37-pin Handler interface)
Included accessories	Analog output (DC 0 V to 3.1 V)
	100 to 240 V AC, 50 Hz/60 Hz, 35 VA max.
LAN (TCP/IP, 10BASE-T/100BASE-TX)	215 mm (8.46 in) W × 80 mm (3.15 in) H × 295 mm (11.61 in) D, 2.4 kg (84.7 oz)
	RS-232C (Max. 38.4 kbps, Available as printer I/F)
Power supply	EXT I/O (37-pin Handler interface)
	Analog output (DC 0 V to 3.1 V)
Dimensions and mass	100 to 240 V AC, 50 Hz/60 Hz, 35 VA max.
	215 mm (8.46 in) W × 80 mm (3.15 in) H × 295 mm (11.61 in) D, 2.4 kg (84.7 oz)
Included accessories	Instruction manual ×1, Power cord ×1, Operating Precautions ×1

#### BT3561A/BT3562A/BT3563A/BT3564/BT3563/BT3562 Series Shared Options

#### Measurement Leads A (for measuring high voltage batteries)



#### PIN TYPE LEAD L2100

A: 300 mm (11.81 in),  
B: 172 mm (6.77 in),  
L: 1400 mm (4.59 ft),  
for high voltage battery measurements, 1000 V DC max.

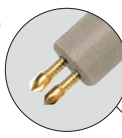

φ7mm  
L: 50mm

#### PIN TYPE LEAD L2110

A: 750 mm (29.53 in),  
B: 215 mm (8.46 in),  
L: 1880 mm (9.17 ft),  
for high voltage battery measurements, 1000 V DC max.



TIP PIN 9772-90  
To replace the tip on the Pin type lead 9772, L2100/L2110, (one piece)

# Battery Testers

## Fully Automated Production Line Testing of Large Packs for xEVs or Large Packs of up to 300 V

### BATTERY HiTESTER BT3563A



LAN

RS-232C



- Simultaneous measurement of internal resistance and open circuit voltage
- Fully automated production line testing of large packs for xEVs or large packs of up to 300 V
- Resistance measurement ranges: 3 mΩ/30 mΩ/300 mΩ/3 Ω/30 Ω/300 Ω/3 kΩ
- Voltage measurement ranges: 6 V/60 V/300 V
- Equipped with LAN

Model No. (Order Code) **BT3563A**

Note: Measurement leads are not included. Purchase the appropriate lead option for your application separately. The male (system side) of the EXT I/O connector is also available. Please contact your authorized Hioki distributor or reseller.

#### Basic specifications (Accuracy guaranteed for 1 year)

Resistance measurement ranges	3 mΩ (Max. display: 3.1000 mΩ, resolution: 0.1 μΩ, measurement current: 100 mA) 30 mΩ (Max. display: 31.000 mΩ, resolution: 1 μΩ, measurement current: 100 mA) 300 mΩ (Max. display: 310.00 mΩ, resolution: 10 μΩ, measurement current: 10 mA) 3 Ω (Max. display: 3.1000 Ω, resolution: 100 μΩ, measurement current: 1 mA) 30 Ω (Max. display: 31.000 Ω, resolution: 1 mΩ, measurement current: 100 μA) 300 Ω (Max. display: 310.00 Ω, resolution: 10 mΩ, measurement current: 10 μA) 3 kΩ (Max. display: 3.1000 kΩ, resolution: 100 mΩ, measurement current: 10 μA)
Voltage measurement ranges	6 V (Max. display: 6.00000 V, resolution: 10 μV) 60 V (Max. display: 60.0000 V, resolution: 100 μV) 300 V (Max. display: 300.000 V, resolution: 1 mV)
Response time	10 ms
Sampling period	Ω or V (60 Hz): 4 ms (EX.FAST), 12 ms (FAST), 35 ms (MEDIUM), 150 ms (SLOW) ΩV (60 Hz): 8 ms (EX.FAST), 24 ms (FAST), 70 ms (MEDIUM), 253 ms (SLOW) Ω or V (50 Hz): 4 ms (EX.FAST), 12 ms (FAST), 42 ms (MEDIUM), 157 ms (SLOW) ΩV (50 Hz): 8 ms (EX.FAST), 24 ms (FAST), 84 ms (MEDIUM), 259 ms (SLOW)
Functions	Contact check, Zero adjustment (±1000 counts), Pulse measurement, Comparator (Hi/IN/Lo), Statistical calculations (Max. 30,000), Delay, Average, Panel saving/loading, Memory storage, LabVIEW® driver
Interfaces	LAN (TCP/IP, 10BASE-T/100BASE-TX) RS-232C (Max. 38.4 kbps, Available as printer I/F) EXT I/O (37-pin Handler interface) Analog output (DC 0 V to 3.1 V)
Power supply	100 to 240 V AC, 50 Hz/60 Hz, 35 VA max.
Dimensions and mass	215 mm (8.46 in) W × 80 mm (3.15 in) H × 295 mm (11.61 in) D, 2.4 kg (84.7 oz)
Included accessories	Instruction manual ×1, Power cord ×1, Operating Precautions ×1

## 1000V Maximum Input Voltage, High-Voltage Battery Tester for Measuring EV and PHEV Battery Packs

### BATTERY HiTESTER BT3564



GP-IB

RS-232C



- Measure high-voltage battery packs up to 1000V
- Production line testing of high-voltage battery packs for EV, PHEV
- 0.1 μΩ to 3000 Ω internal resistance range (pack total resistance, bus bar resistance)
- Spark discharge reduction function
- Analog output function
- Optional measurement probe available for 1000 V and high-voltage battery packs

Model No. (Order Code) **BT3564**

Note: Measurement leads are not included. Purchase the appropriate lead option for your application separately. The male (system side) of the EXT I/O connector is also available. Please inquire with your Hioki distributor.

#### Basic specifications (Accuracy guaranteed for 1 year)

Max. applied measurement voltage	± 1000 VDC rated input voltage ± 1000 VDC max. rated voltage to earth
Resistance measurement ranges	3 mΩ (max. display 3.1000 mΩ, resolution 0.1 μΩ) to 3000 Ω (max. display 3100.0 Ω, resolution 0.1 Ω), 7 ranges Accuracy: ±0.5% rdg ±5 dgt (30 mΩ to 3000 Ω range), ±0.5% rdg ±10 dgt (3 mΩ range) Testing source frequency: 1 kHz ±0.2 Hz, testing current: 100 mA (3 mΩ range) to 10 μA (3000 Ω range) Open terminal Voltage: 25 V peak (3/30 mΩ ranges), 7 V peak (300 mΩ range), 4 V peak (3 Ω to 3000 Ω range)
Voltage measurement ranges	10 V DC (resolution: 10 μV) to 1000V DC (resolution: 1 mV), 3 ranges Accuracy: ±0.01% rdg ±3 dgt
Display	31000 full digits (resistance), 999999 full digits (voltage, 1000 V range: 999999 or 110000), LED
Sampling time	FAST: 12 ms, MEDIUM: 35 ms, SLOW: 253 ms (Typ., sampling time depends on supply frequency settings and function.)
Total measurement time	Response time + sampling time (Response time for both resistance and voltage are reference value of about 700 ms, depends on measurement object.)
Comparator functions	Judgment result: Hi/IN/Lo (resistance and voltage judged independently) Setting: Upper and lower limit, Deviation (%) from reference value Logical ANDed result: PASS/FAIL, calculates the logical AND of resistance and voltage judgment results. Result display, beeper, or external I/O output (open-collector, 35 V, 50 mA DC max.)
Analog output	Measured resistance (displayed value, from 0 to 3.1 V DC)
Interfaces	External I/O, RS-232C, Printer (RS-232C), GP-IB
Power supply	100 to 240 V AC, 50/60 Hz, 30 VA max.
Dimensions and mass	215 mm (8.46 in) W × 80 mm (3.29 in) H × 295 mm (12.95 in) D, 2.4 kg (84.7 oz)
Included accessories	Instruction manual ×1, Power cord ×1, Operating Precautions ×1

#### About probe length

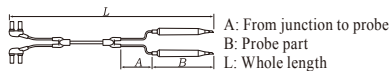

#### BT3561A/BT3562A/BT3563A/BT3564/BT3563G/BT3562 Series Shared Options

##### Measurement Leads B (for measuring batteries up to 60 V)

1.8 mm dia. single-axis type for measuring small electrodes

0.2 mm parallel pyramid-type pins for measuring at thru holes and sub-millimeter objects

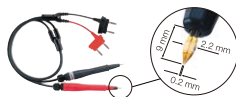
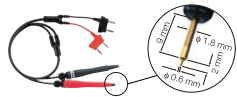

**PIN TYPE LEAD 9770**  
A: 260 mm (10.24 in),  
B: 140 mm (5.51 in),  
L: 850 mm (2.79 ft), 60V DC

**TIP PIN 9770-90**  
Replacement tip for pin type lead 9770, L2102

**PIN TYPE LEAD 9771**  
A: 260 mm (10.24 in),  
B: 138 mm (5.43 in),  
L: 850 mm (2.79 ft), 60V DC

**TIP PIN 9771-90**  
Replacement tip for pin type lead 9771, L2103

##### Measurement Leads C (for measuring batteries up to 60 V)



**CLIP TYPE LEAD L2107**  
A: 130 mm (5.12 in),  
B: 83 mm (3.27 in),  
L: 1100 mm (3.61 ft), 60 VDC

**FOUR TERMINAL LEAD 9453**  
A: 280 mm (11.02 in),  
B: 118 mm (4.65 in),  
L: 1360 mm (4.46 ft), 60V DC

**LARGE CLIP TYPE LEAD 9467**  
A: 300 mm (11.81 in),  
B: 131 mm (5.16 in),  
L: 1310 mm (4.30 ft), tip φ 29 mm (1.14 in), 50 V DC

Can not be used for PIN TYPE LEAD 9770, 9771

**Option**  
O ADJ BOARD Z5038  
For L2100, L2110, L2020, 9465-10, 9772

**PC communication**  
RS-232C CABLE 9637  
For the PC, 9pin - 9pin, cross, 1.8 m (5.91 ft) length  
GP-IB CONNECTOR CABLE 9151-02  
2 m (6.56 ft) length



## High-speed Measurement from Large-cell to High-voltage Battery Testing

### BATTERY HiTESTER BT3563-01, BT3562-01



GP-IB  
BT3563-01, BT3562-01  
RS-232C



3 Year  
Warranty

- Measure high-voltage battery packs up to 300V (BT3563-01)
- Measure the voltage of battery packs up to 60 V (BT3562-01)
- Production line testing of high-voltage battery packs and battery modules
- Large (low-resistance) cell testing
- Choice of PC interfaces for full remote operation

Note: The comparison threshold values depend on the battery manufacturer, type, and capacity, and these must be established by the user.

Model No. (Order Code) **BT3563-01** (Built-in GP-IB and analog output)  
**BT3562-01** (Built-in GP-IB and analog output)

Note: Measurement leads are not included. Purchase the appropriate lead option for your application separately. The male (system side) of the EXT I/O connector is also available. Please inquire with your Hioki distributor.

#### Basic specifications (Accuracy guaranteed for 1 year)

	BT3563-01	BT3562-01
Max. applied measurement voltage	± 300 VDC rated input voltage ± 300 VDC max. rated voltage to earth	± 60 VDC rated input voltage ± 70 VDC max. rated voltage to earth
Resistance measurement ranges	3 mΩ (max. display 3,1000 mΩ, resolution 0.1 μΩ) to 3000 Ω (max. display 3100.0 Ω, resolution 100 mΩ), 7 ranges Accuracy: 30 mΩ to 3000 Ω ranges, ± 0.5% rdg ± 5 dgt (Add ± 3 dgt for EX.FAST, or ± 2 dgt for FAST and MEDIUM) 3 mΩ range, ± 0.5% rdg ± 10 dgt (Add ± 30 dgt for EX.FAST, or ± 5 dgt for FAST, or ± 5 dgt for MEDIUM) Testing source frequency: 1 kHz ± 0.2 Hz, testing current: 100 mA (3 mΩ range) to 10 μA (3000 Ω range) Open terminal Voltage: 25 V peak (3/30 mΩ ranges), 7 V peak (300 mΩ range), 4 V peak (3 Ω to 3000 Ω ranges)	
Voltage measurement ranges	6 VDC (resolution 10 μV) to 300 VDC (resolution 1 mV), 3 ranges	6 VDC (resolution 10 μV) to 60 VDC (resolution 100 μV), 2 ranges
Display	31000 full digits (resistance), 600000 full digits (voltage), LED	
Sampling rate	Four steps, 4 ms (Extra-FAST), 12 ms (FAST), 35 ms (Medium), 150 ms (Slow) (Typ., sampling time depends on supply frequency settings and function.)	
Measurement time	Response time + sampling rate, approx. 10 ms for measurements (Response time depends on reference values and the measurement object.)	
Comparator functions	Judgment result: Hi/IN/Lo (resistance and voltage judged independently) Setting: Upper and lower limit, Deviation (%) from reference value Logical ANDed result: PASS/FAIL, calculates the logical AND of resistance and voltage judgment results. Result display, beeper, or external I/O output, Open-collector (35 V, 50 mA DC max.)	
Analog output	Measured resistance (displayed value, from 0 to 3.1 V DC)	
Interfaces	External I/O, RS-232C, Printer (RS-232C), GP-IB (-01 suffix models only)	
Power supply	100 to 240 VAC, 50/60 Hz, 30 VA max.	
Dimensions and mass	215 mm (8.46 in) W × 80 mm (3.15 in) H × 295 mm (11.61 in) D, 2.4 kg (84.7 oz)	
Included accessories	Instruction manual ×1, Power cord ×1	

## For High-speed Production Line Testing of Small Battery Packs

### BATTERY HiTESTER 3561



GP-IB  
3561-01  
RS-232C



3 Year  
Warranty

- High-speed testing for production lines of small battery packs for mobile and portable communications devices
- Measure internal resistance and battery voltage
- For process control such as in high-speed automated assembly lines

Note: The comparison threshold values depend on the battery manufacturer, type, and capacity, and these must be established by the user

Model No. (Order Code) **3561**  
**3561-01** (Built-in GP-IB interface)

Note: Measurement leads are not included. Purchase the appropriate lead option for your application separately. The male (system side) of the EXT I/O connector is also available. Please inquire with your Hioki distributor.

#### Basic specifications (Accuracy guaranteed for 1 year)

Max. applied measurement voltage	±22 V DC ±60 V DC maximum rated voltage above ground
Resistance measurement ranges	300 mΩ (max. display 310.00 mΩ, resolution 10 μΩ) to 3 Ω (max. display 3.1000 Ω, resolution 100 μΩ), 2 ranges Accuracy: ±0.5 % rdg ±5 dgt (Add ±3 dgt for EX.FAST, or ±2 dgt for FAST and MEDIUM) Testing source frequency: 1 kHz ±0.2 Hz, testing current: 10 mA (300 mΩ range), 1 mA (3 Ω range) Open terminal Voltage: 7 V peak
Voltage measurement ranges	DC 20 V, resolution 0.1 mV, Accuracy: ±0.01 % rdg ±3 dgt (Add ±3 dgt for EX.FAST, or ±2 dgt for FAST and MEDIUM)
Display	31000 full digits (resistance), 199999 full digits (voltage), LED
Sampling rate	Four steps, 4 ms (Extra-FAST), 12 ms (FAST), 35 ms (Medium), 150 ms (Slow) (Typ., sampling time depends on supply frequency settings and function.)
Measurement time	Response time + sampling rate, approx. 3 ms for measurements (Response time depends on reference values and the measurement object.)
Comparator functions	Judgment result: Hi/IN/Lo (resistance and voltage judged independently) Setting: Upper and lower limit, Deviation (%) from reference value Logical ANDed result: PASS/FAIL, calculates the logical AND of resistance and voltage judgment results. Result display, beeper, or external I/O output, Open-collector (35 V, 50 mA DC max.)
Interfaces	External I/O, RS-232C, Printer (RS-232C), GP-IB (-01 suffix models only)
Power supply	100 to 240 V AC, 50/60 Hz, 30 VA max.
Dimensions and mass	215 mm (8.46 in) W × 80 mm (3.15 in) H × 295 mm (11.61 in) D, 2.4 kg (84.7 oz)
Included accessories	Instruction manual ×1, Power cord ×1

#### Measurement Leads B (for measuring batteries up to 60 V)

1.8 mm dia. single-axis type for measuring small electrodes

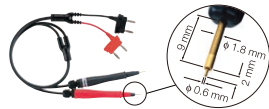

**PIN TYPE LEAD 9770**  
A: 260 mm (10.24 in),  
B: 140 mm (5.51 in),  
L: 850 mm (2.79 ft), 60V DC

**TIP PIN 9770-90**  
Replacement tip for pin type lead 9770, L2102

0.2 mm parallel pyramid-type pins for measuring at thru holes and sub-millimeter objects

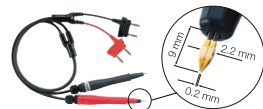

**PIN TYPE LEAD 9771**  
A: 260 mm (10.24 in),  
B: 138 mm (5.43 in),  
L: 850 mm (2.79 ft), 60V DC

**TIP PIN 9771-90**  
Replacement tip for pin type lead 9771, L2103

#### Measurement Leads C (for measuring batteries up to 60 V)



**CLIP TYPE LEAD L2107**

A: 130 mm (5.12 in), B: 83 mm (3.27 in), L: 1100 mm (3.61 ft), 60 VDC

**FOUR TERMINAL LEAD 9453**

A: 280 mm (11.02 in), B: 118 mm (4.65 in), L: 1360 mm (4.46 ft), 60V DC

**LARGE CLIP TYPE LEAD 9467**

A: 300 mm (11.81 in), B: 131 mm (5.16 in), L: 1310 mm (4.30 ft), tip φ 29 mm (1.14 in), 50 V DC

#### About probe length

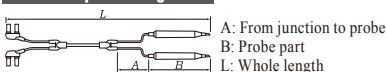

A: From junction to probe  
B: Probe part  
L: Whole length

#### PC communication



**RS-232C CABLE 9637**  
For the PC, 9pin - 9pin, cross, 1.8m (5.91 ft) length

**GP-IB CONNECTOR CABLE 9151-02**  
2 m (6.56 ft) length

## Achieve Long Service Life Battery Modules by Measuring Reaction Resistance

### BATTERY IMPEDANCE METER BT4560



USB 2.0

RS-232C

CE

3 Year Warranty

- Low-frequency AC-IR measurement\* : Measure the reaction resistance of a battery  
\*The BT4560 ensures battery cell quality by measuring internal impedance at a low frequency of 1 Hz or below
- Extremely reliable measurements for low-impedance batteries  
\*The BT4560 uses a testing current of 1.5 A at the 3mΩ range, which improves the S/N ratio
- Circuit configuration highly tolerant of contact and wire resistance to provide stable measurements
- Voltage measurement function equivalent to 6-digit DMM ( $\pm 0.0035\%$  rdg)

Model No. (Order Code) **BT4560**

Note: This product is not supplied with measurement probes. Please select and purchase the measurement probe options appropriate for your application separately.

#### Basic specifications (Accuracy guaranteed for 1 year)

Allowable input voltage	Up to 5 V
Measured information	Impedance, voltage, temperature
Impedance measurement	Parameters: R, X, Z, $\theta$ , Frequency: 0.1 Hz to 1050 Hz, Measurement ranges: 3.0000 mΩ, 10.0000 mΩ, 100.000 mΩ Testing current: 3 mΩ range: 1.5 Arms, 10 mΩ range: 500 mArms, 100 mΩ range: 50 mArms
Voltage measurement	Measurement range: 5.00000 V (single range), Measurement time: 0.1 s (Fast) to 1.0 s (Slow)
Temperature measurement	Range: -10.0 °C to 60.0 °C, Measurement time: 2.3 s
Basic accuracy	Z: $\pm 0.4\%$ rdg $\theta$ : $\pm 0.1^\circ$ , V: $\pm 0.0035\%$ rdg $\pm 5$ dgt, Temperature: $\pm 0.5^\circ$ C (at 10.0 to 40.0 °C)
Functions	Comparator, self-calibration, sample delay, average, contact check, measurement current error, and other
Interfaces	RS-232C/USB (virtual COM port) * Cannot be used simultaneously EXT. I/O (NPN/PNP can be switched)
Power supply	100 to 240 V AC, 50/60 Hz, 80 VA max
Dimensions and mass	330 mm (12.99 in) W $\times$ 80 mm (3.15 in) H $\times$ 293 mm (11.54 in) D, 3.7 kg (130.5 oz)
Included accessories	Power cord $\times$ 1, Instruction manual $\times$ 1, Zero-adjustment board $\times$ 1, USB cable (A-B type) $\times$ 1, CD-R (communication instruction manual, PC application software, USB driver) $\times$ 1

Measurement Probes, Sensors



CLIP TYPE PROBE L2002  
Cable length 1.5 m (4.92 ft) length



PIN TYPE PROBE L2003  
Cable length 1.5 m (4.92 ft) length



TEMPERATURE SENSOR  
Z2005  
Cable length 1 m (3.28 ft) length

PC communication



RS-232C CABLE 9637  
For the PC, 9pin - 9pin,  
cross, 1.8m (5.91 ft) length

# Battery Testers

## Even Speedier Diagnosis of the Deterioration of Lead-acid Batteries Including UPS

### BATTERY TESTER BT3554-50



USB 2.0

CE

3 Year Warranty

Bluetooth

When Z3210 is installed

- Battery measurement can be performed while the battery is connected to its host device, without taking it offline
- Measure and save data in as fast as 2 seconds, a 60% improvement from the legacy 3554
- Instantaneously diagnose battery degradation (PASS, WARNING, FAIL) by measuring internal resistance and voltage\*1
- Noise reduction technology improves noise resistance
- Screen and audio\*2 guidance simplifies measurement
- Measurement data is linked to site information and saved, reducing management man-hours
- A variety of measurement data can be centrally managed using Hioki's GENNECT Cross app\*3
- Easily transfer measurement data to your smartphone or tablet by using our free app GENNECT Cross or to an Excel® file. (Wireless Adapter Z3210 is necessary)
- New protector delivers better ergonomic hold and durability in the field.

Model No. (Order Code) **BT3554-50** (Pin Type Lead not included)  
**BT3554-51** (Bundled with Pin Type Lead 9465-10)  
**BT3554-52** (Bundled with Pin Type Lead L2020)  
**BT3554-91** (BT3554-51 + Wireless Adapter Z3210)  
**BT3554-92** (BT3554-52 + Wireless Adapter Z3210)

\*1: The thresholds for determining the pass/fail condition of a battery depends on the specifications and standards of the battery manufacturer, battery type, capacity, etc. It is important and necessary to always conduct battery testing against the internal resistance and terminal voltage of a new or reference battery. In some cases, it may be difficult to determine the deterioration state of traditional open type (liquid) lead-acid or alkaline batteries which demonstrate smaller changes in internal resistance than sealed lead acid batteries. \*2: Audio generated by Bluetooth®-connected device. \*3: Data can be downloaded to tablets and smartphones using Hioki's dedicated apps available from the Google Play or App Store. (When using the Z3210)

■ Data can be downloaded to tablets and smartphones using Hioki's dedicated apps available from the Google Play or App Store. Search for "HIOKI" and download the "GENNECT Cross" app.



#### ■ Basic specifications (Accuracy guaranteed for 1 year)

	BT3554-50	BT3554-51	BT3554-52
Resistance measurement range	3 mΩ (max. display 3.100 mΩ, resolution 1 μΩ) to 3 Ω (max. display 3.100 Ω, resolution 1 mΩ), 4 ranges Accuracy: ±0.8% rdg ±6 dgt (3 mΩ range: ±1.0% rdg ±8 dgt) Testing source frequency: 1 kHz ±30 Hz With function for avoiding noise frequency enabled: 1 kHz ±80 Hz Testing current: 160 mA (3m/30 mΩ range), 16 mA (300 mΩ range), 1.6 mA (3 Ω range) Open terminal Voltage: 5 V peak		
Voltage measurement range	± 6 V (max. display ±6.000 V, resolution: 1 mV) to ± 60 V (max. display ±60.00 V, resolution: 10 mV), 2 ranges, Accuracy: ±0.08% rdg ±6 dgt		
Temperature measurement accuracy	Measurement range: -10°C to 60°C (14°F to 140°F), Maximum display: 60.0°C (140.0°F), Resolution 0.1°C (0.1°F), Measurement accuracy*: ±1.0°C (±1.8°F) * When using the Clip Type Lead with Temperature Sensor 9460. * When using the Temperature Probe 9451, add ±0.5°C (±0.9°F) (cable length: 1.5 m [59.1"]). * When using the Temperature Probe 9451S, add ±0.5°C (±0.9°F) (cable length: 0.1 m [3.94"]). BT3554-50 standalone accuracy with simulated input: ±0.5°C (±0.9°F)		
Absolute max. input voltage	60 V DC max. (No AC input)		
Measurement time	100 ms		
Response time	Approx. 1.6 sec.		
Comparator	Compares measured values with set threshold values to make judgments and reports them to the user. Judgment notification method: Results are displayed as shown below (segment) and beeping tones sound When the Voltage value (high): Resistance value (low)= PASS, Resistance value (medium)= WARNING, Resistance value (high)= FAIL When the Voltage value (low): Resistance value (low)= WARNING, Resistance value (medium)= WARNING, Resistance value (high)= FAIL If the judgment result is WARNING or FAIL, the audio tone is accompanied by a red backlight. User-selectable voltage judgment method: ABS (absolute value judgment), POL (polarity judgment) Savable settings: 200 tables		
Memory functionality	Operation: Save, load, and delete measurement data, Save and delete profile information, Number of data sets: 6000, Memory architecture: 500 data sets per unit (12 units) Saved data: Saved measurement data is linked to profile information. 1. Measurement data: Data can be saved, loaded, and deleted by operating the instrument. -1. Date and time -2. Resistance value, voltage value, and temperature -3. Comparator threshold value and judgment result 2. Profile information: Profile information can be saved, loaded, and deleted using a supported application (GENNECT Cross or GENNECT One). -1. Profile numbers: 1 to 100 (Data (2), (3), and (4) below are saved for each profile number) -2. Location: User-defined comment such as location of UPS -3. Device information: User-defined comment such as UPS management number -4. Battery number: 1 to 500 (start number, end number)		
Measurement Navigator	Operation: Announces the next battery number to be measured via a screen display and audio guidance. Audio output is generated by a connected mobile device when using the Z3210 and a supported application (GENNECT Cross). Preparations: Profile information that's been registered with a supported application (GENNECT Cross or GENNECT One) must be transferred to the instrument.		
Communication interface	USB Bluetooth® wireless communications (when Z3210 installed)		
Other functions	Temperature measurement (-10.0 to 60.0 °C), Zero-adjustment, Hold, Auto-hold, Auto-memory, Auto-power-save, Clock		
Power supply	LR6 (size AA) alkaline battery × 8 Rated supply voltage: 1.5 V DC × 8 (Nickel metal hydride batteries may be used. However, the battery life display is not supported in this configuration.) Continuous operating time: Approx. 8.3 hr. (without Z3210 installed), Approx. 8.2 hr. (with Z3210 installed and wireless communications active)		
Dimensions and mass	199 mm (7.83 in)W × 132 mm (5.20 in)H × 60.6 mm (2.39 in)D (with protector), 960 g (33.9 oz) (including batteries and protector)		
Included accessories	Carrying Case C1014 ×1, Protector Z5041 ×1, Fuse Set Z5050 ×1, 0 Adj Board ×1, Neck strap ×1, USB cable ×1, Application software CD (GENNECT One) ×1, AA alkaline battery (LR6) ×8, User Manual ×1		
	Instrument only	With Pin Type Lead 9465-10	With Pin Type Lead L2020

Battery Testers

Easy 4-terminal measurement, 2.7 mm dia. single-axis type

**PIN TYPE LEAD L2020**  
A: 70 mm (2.76 in) (Red), 150 mm (5.91 in) (Black, up to 630 mm (24.8 in)), B: 164 mm (6.46 in), L: 1941 mm (76.42 in) (Red)

**TIP PIN 9465-90**  
To replace the tip on the 9465-10, L2020, (one piece)

**PIN TYPE LEAD 9465-10**  
A: 45 mm (1.77 in) red, 105 mm (4.13 in) black 515 mm (20.28 in) (4.13 in) black 515 mm (20.28 in), L: 1310 mm (51.57 in), L: 2268 mm (89.29 in) (Black), B: 176 mm (6.93 in), L: 1883 mm (74.13 in) (Red)

Large angle of probe application, 2.5 mm pitch 2-axis pin type

**PIN TYPE LEAD 9772**  
A: 45 mm (1.77 in) red, 105 mm (4.13 in) black 515 mm (20.28 in) Max., B: 173 mm (6.81 in), L: 1880 mm (74.17 in)

**TIP PIN 9772-90**  
To replace the tip on the Pin type lead 9772, L2100/L2110, (one piece)

**LARGE CLIP TYPE LEAD 9467**  
A: 300 mm (11.81 in), B: 131 mm (5.16 in), L: 1310 mm (51.57 in), tip ø 29 mm (1.14 in), 50 V DC

**CLIP TYPE LEAD WITH TEMPERATURE SENSOR 9460**  
For the 3554, 3540, A:300 mm (11.81 in), B:106 mm (4.17 in), L:2268 mm (74.4 ft)

**REMOTE CONTROL SWITCH 9466**  
Can hold the valves while measuring them, for the BT3554 (use with the L2020, 9772, 9465-10)

**About probe length**

A: From junction to probe  
B: Probe part  
L: Whole length

**Temperature Probe**

**Temperature Probe 9451S**  
L: 100 mm (3.94")  
Order code **9451-01**

**Temperature Probe 9451**  
L: 1500 mm (59.06")

**Option**

**0 ADJ BOARD Z5038**  
For L2020, 9465-10, and 9772

**FUSE SET Z5050**  
Replacement fuse set (5 pieces), for the BT3554

**Protector Z5041**  
For BT3554 and BT3554-50

**Carrying Case C1014**  
Hard case

**PC peripherals**

**GENNECT One SF4000**  
Application for Windows

**GENNECT Cross SF4071, SF4072**  
Mobile app for iOS, Android

# Super Megohm Testers (High Resistance Meters)

## Test System Ideal for MLCC Leakage Current Measurement

### SUPER MΩ HiTESTER SM7810



GP-IB

RS-232C

Not CE Marked



- Test the leakage current of MLCCs at the fastest speed of 6.8ms simultaneously over 8 channels
- Conduct high-speed leakage current testing of large-capacity MLCCs in the high current range (1mA)
- Improve testing reliability using the contact check function
- Build a flexible system by making best use of the individual settings of each channel

Model No. (Order Code) **SM7810** (100/110V AC power supply)  
**SM7810-20** (220V AC power supply)

The Super MΩ HiTESTER SM7810 is produced to order. An input/output terminal connection cable\*1 is required separately. Please contact your local HIOKI representative.

\*1 Input/output terminal connector/plug and connection cable

• Current input terminal connector and voltage output terminal plug are not included. Voltage input terminal connector is included.

• Input/output terminal connection cables are available in various lengths to suit HIOKI measurement systems. Please consult with your HIOKI representative.

MEASURING LEAD (BLACK) OGA00016	MEASURING LEAD (RED) OGA00019	MEASURING LEAD (RED) OGA00021	MEASURING LEAD (RED) OGA00027
Discontinued 5 m (16.41 ft) length	1 m (3.28 ft) length	2 m (6.56 ft) length	5 m (16.41 ft) length

#### Basic specifications (Accuracy guaranteed for 1 year)

Number of channels	8 channels (parallel and simultaneous measurement)
Applied voltage	Supply voltage from external power source (voltage input terminal on the rear panel)
Measurement range	Current: 1 pA to 1 mA, Ranges: 100 pA/ 1 nA/ 10 nA/ 100 nA/ 1 μA/ 10 μA/ 100 μA/ 1 mA Resistance: $1 \times 10^2 \Omega$ to $1 \times 10^{15} \Omega$
Measurement speed INDEX typical time	FAST: 6.8 ms, MED: 26.0 ms, SLOW: 100.0 ms, SLOW2: 320.0 ms
Basic measurement accuracy (1pA range, FAST)	Current accuracy: $\pm(2.0 + (0.5 \mu A / (\text{Measured current value}))) \%$ Resistance accuracy: Current accuracy + Voltage generation accuracy of external power supply
Testing voltage setting	0.1 V to 1000.0 V (Resolution: 0.1 V)
Contact check	Judges the contact state by comparing the measured capacitance to a reference value
Other functions	Trigger delay, averaging, contact check, jig capacity open correction, Measured value comparison and judgment, jig resistance open correction functions
Interfaces	GP-IB, RS-232C, EXT I/O
Power supply	SM7810: AC 100 V/110 V, 50/60 Hz, 30 VA SM7810-20: AC 220 V, 50/60 Hz, 30 VA
Dimensions and mass	425 mm (16.73 in) W × 99 mm (3.90 in) H × 488 mm (19.21 in) D, 10.5 kg (370.4 oz)
Included accessories	Power cord ×1, Instruction manual ×1, Voltage input connector L2220 ×1, Spare fuse (built into inlet) ×1, Rubber feet ×4

PC communication



RS-232C CABLE 9637  
For the PC, 9pin - 9pin, cross, 1.8m (5.91 ft) length



GP-IB CONNECTOR CABLE 9151-02  
2 m (6.56 ft) length

Bundle Accessories



CONNECTOR L2220  
Voltage input connector for SM7810

## The Power Source Unit Ideal for MLCC Leakage Current Measurement

### POWER SOURCE UNIT SM7860 series



GP-IB

RS-232C

Not CE Marked



Combination example of the SM7610

Model No. (Order Code) **SM7860-51 /-52 /-53 /-54 /-55 /-56 /-57 /-58** (100V AC power supply)  
**SM7860-61 /-62 /-63 /-64 /-65 /-66 /-67 /-68** (220V AC power supply)

The Power Source Unit SM7860 is produced to order. An output terminal connection cable\*2 is required separately. Please contact your local HIOKI representative, or if you need to use a power supply voltage other than 100VAC or 220VAC.

\*2 Output terminal cable

• Voltage output terminal connection cables are available in various lengths to suit HIOKI measurement systems. Please consult with your HIOKI representative.

- Support for multi-channel systems up to 32-channel output
- 8-channels or 16-channels dual-line output voltage setting
- Positive and negative polarities required for the MLCC test line included in a single unit
- Output ON/OFF and current limitation can be performed for each channel
- Support for the discharge of the charge capacitor
- Output voltage of 1 kV is available
- Large current output of 50 mA \*channel allows for reducing the number of backup charges

\* Output voltage of 1 kV is limited to 10 mA/channel

#### Basic specifications (Accuracy guaranteed for 1 year)

Supported device	Super MΩ HiTester SM7810 Object to which voltage is applied: MLCC (the Multilayer Ceramic Capacitor)
Generation accuracy	Output voltage accuracy: $\pm 2\%$ of set value $\pm 0.5$ V (with no load) Inter-channel error: $\pm 0.1$ V or less (between outputs on the same line with no load)
Interfaces	GP-IB, RS-232C, EXT I/O
Power supply	SM7860-51 to -58: 100 V AC, SM7860-61 to -68: 220 V AC, 50/60 Hz, 860 VA
Dimensions and mass	425 mm (16.73 in) W × 249 mm (9.80 in) H × 581 mm (22.87 in) D, 47 kg (1657.9 oz) [SM7860-57 / -67]: 34 kg (1199.3 oz)
Included accessories	Power cable ×1, Instruction manual ×1, Operating precautions ×1

Other



CONNECTOR L2221  
Voltage output connector for SM7860

### SM7860 Functions & output channel configuration

SM7860-XX*1		-51 / -61	-52 / -62	-53 / -63	-54 / -64	-55 / -65	-56 / -66	-57 / -67	-58 / -68
OUT1 to 4 output content	OUT1	+500V	+500V	+1kV	+1kV	+500V	discharge	+1kV	discharge
	OUT2	+500V	+500V	+1kV	+1kV	+500V	discharge	+10V	+10V
Overview (Total number of channels and output voltage)		32ch + 500V	32ch + 1000V	32ch ±500V	32ch ±1000V	32ch ±500V, discharge	32ch ±1000V, discharge	32ch + 10V, discharge	32ch + 500V, discharge
	Line A								
Line A	Number of OUT1 channels	8 ch	8 ch	8 ch	8 ch	8 ch	8 ch	8 ch	8 ch
	OUT1 output voltage range *2	+1.0 V to +500.0 V	+250.0 V to +1000.0 V	+1.0 V to +500.0 V	+250.0 V to +1000.0 V	+1.0 V to +500.0 V	+250.0 V to +1000.0 V	+1.0 V to +10.0 V	+1.0 V to +500.0 V
	Number of OUT2 channels	8 ch	8 ch	8 ch	8 ch	8 ch	8 ch	8 ch	8 ch
	OUT2 output voltage range *2	+1.0 V to +500.0 V	+250.0 V to +1000.0 V	+1.0 V to +500.0 V	+250.0 V to +1000.0 V	discharge	discharge	+1.0 V to +10.0 V	+1.0 V to +500.0 V
	Current limitation	±50 mA/ch	±10 mA/ch	±50 mA/ch	±10 mA/ch	±50 mA/ch	±10 mA/ch	±50 mA/ch	±50 mA/ch
Maximum output current *2	430 mA (200 VA)	100 mA (100 VA)	430 mA (200 VA)	100 mA (100 VA)	430 mA (200 VA)	100 mA (100 VA)	430 mA (4 VA)	430 mA (200 VA)	
Line B	Number of OUT3 channels	8 ch	8 ch	8 ch	8 ch	8 ch	8 ch	8 ch	8 ch
	OUT3 output voltage range *2	+1.0 V to +500.0 V	+250.0 V to +1000.0 V	-1.0 V to -500.0 V	-250.0 V to -1000.0 V	-1.0 V to -500.0 V	-250.0 V to -1000.0 V	+1.0 V to +10.0 V	+1.0 V to +500.0 V
	Number of OUT4 channels	8 ch	8 ch	8 ch	8 ch	8 ch	8 ch	8 ch	8 ch
	OUT4 output voltage range *2	+1.0 V to +500.0 V	+250.0 V to +1000.0 V	-1.0 V to -500.0 V	-250.0 V to -1000.0 V	discharge	discharge	discharge	discharge
	Current limitation	±50 mA/ch	±10 mA/ch	±50 mA/ch	±10 mA/ch	±50 mA/ch	±10 mA/ch	±50 mA/ch	±50 mA/ch
Maximum output current *3	430 mA (200 VA)	100 mA (100 VA)	430 mA (200 VA)	100 mA (100 VA)	430 mA (200 VA)	100 mA (100 VA)	430 mA (4 VA)	430 mA (200 VA)	

\*1 SM7860-51 to -58: Power supply 100 V AC, SM7860-61 to -68: Power supply 220 V AC \*2 The resolution of the output voltage range is 0.1 V.

\*3 Only when the operating conditions as stated in the restriction warnings of the specifications are met.

# Super Megohm Testers (High Resistance Meters)

## 4ch Micro Current Model /Perfect for Automated-Systems Integration

### SUPER MEGOHM METER SM7420



USB 2.0

GP-IB

RS-232C

CE

3 Year Warranty

- 300 times better noise resistance
- 6000 ps/minute - ideal for mass production
- Channel-independent low capacity contact check
- Perfect for equipping on automated machines
- Max.  $2 \times 10^{19} \Omega$  display
- Min. 0.1 fA resolution
- Built-in EXT I/O, RS-232C, GP-IB and USB
- Ideal for mounting in automated lines, easy to construct MLCC leakage current inspection lines

Model No. (Order Code) **SM7420** (4ch, Dedicated micro current measurement)

Note: Measurement leads are not included. Purchase the appropriate lead option for your application separately.

#### Basic specifications (Accuracy guaranteed for 1 year)

Number of channels	4ch
DC current measurement	20 pA range (0.1 fA resolution), Accuracy: $\pm(2.0\%$ of rdg +30 dgt) 200 pA range (1.0 fA resolution), Accuracy: $\pm(1.0\%$ of rdg +30 dgt) 2 nA range (10 fA resolution), Accuracy: $\pm(0.5\%$ of rdg +20 dgt) 20 nA range (100 fA resolution), Accuracy: $\pm(0.5\%$ of rdg +10 dgt) 200 nA range (1 pA resolution), Accuracy: $\pm(0.5\%$ of rdg +10 dgt) 2 $\mu$ A range (10 pA resolution), Accuracy: $\pm(0.5\%$ of rdg +10 dgt) 20 $\mu$ A range (100 pA resolution), Accuracy: $\pm(0.5\%$ of rdg +10 dgt) 200 $\mu$ A range (1 nA resolution), Accuracy: $\pm(0.5\%$ of rdg +10 dgt) *2 mA range (1 nA resolution), Accuracy: $\pm(0.5\%$ of rdg +30 dgt) (1) Measurement speed SLOW2 (internal integration time 13PLC) (2) At a temperature of 23 °C $\pm 5$ °C with humidity of 85% rh (3) 2 mA range (Measurement speed FAST only)
Resistance measurement capabilities	50 $\Omega$ to $2 \times 10^{19} \Omega$ Note: Resistance measurement accuracy is defined by the current range accuracy and voltage setting accuracy.
Measurement time setting	Delay: 0 to 9,999 msec
Functions	CH independent low capacity contact checks, CH independent cable length correction, CH independent jig capacity open compensation, comparator
Display	LCD (8 lines of 30 characters), with backlight, high voltage warning indicator
Interfaces	USB, RS-232C, GP-IB, EXT I/O (NPN/PNP can be switched)
Power supply	100 to 240V AC, 50/60 Hz, 45 VA
Dimensions and mass	330 mm (12.99 in)W $\times$ 80 mm (3.15 in)H $\times$ 450 mm (17.72 in)D, 6.5 kg (229.3 oz)
Included accessories	Power cord $\times$ 1, Instruction manual $\times$ 1, CD-R (Communications command instruction manual, USB driver) $\times$ 1, EXT I/O male connector $\times$ 1

Super Megohm Testers

## Min. 6.4 ms Measurement of Super Megohm or Very Small Current

### SUPER MEGOHM METER SM7110, SM7120



USB 2.0

GP-IB

RS-232C

CE

3 Year Warranty

- 300 times better noise resistance
- Max. 2000 V output : SM7120
- Max. 1000 V output : SM7110
- Max.  $2 \times 10^{19} \Omega$  display
- Min. 0.1 fA resolution
- Built-in EXT I/O, RS-232C, GP-IB and USB
- Flexible, Multipurpose Design, High Resistance Meter/Electrometer/Picoammeter/IR Meter
- Measure resistance of materials by combining with optional electrode

Model No. (Order Code) **SM7110** (1 ch, 1000 V)  
**SM7120** (1 ch, 2000 V)

Note: Measurement leads are not included. Purchase the appropriate lead option for your application separately.

#### Basic specifications (Accuracy guaranteed for 1 year)

Number of channels	1 ch
DC current measurement	20 pA range (0.1 fA resolution), Accuracy: $\pm(2.0\%$ of rdg +30 dgt) 200 pA range (1.0 fA resolution), Accuracy: $\pm(1.0\%$ of rdg +30 dgt) 2 nA range (10 fA resolution), Accuracy: $\pm(0.5\%$ of rdg +20 dgt) 20 nA range (100 fA resolution), Accuracy: $\pm(0.5\%$ of rdg +10 dgt) 200 nA range (1 pA resolution), Accuracy: $\pm(0.5\%$ of rdg +10 dgt) 2 $\mu$ A range (10 pA resolution), Accuracy: $\pm(0.5\%$ of rdg +10 dgt) 20 $\mu$ A range (100 pA resolution), Accuracy: $\pm(0.5\%$ of rdg +10 dgt) 200 $\mu$ A range (1 nA resolution), Accuracy: $\pm(0.5\%$ of rdg +10 dgt) *2 mA range (1 nA resolution), Accuracy: $\pm(0.5\%$ of rdg +30 dgt) (1) Measurement speed SLOW2 (internal integration time 13PLC) (2) At a temperature of 23 °C $\pm 5$ °C with humidity of 85% rh (3) 2 mA range (Measurement speed FAST only)
Resistance measurement capabilities	$1 \times 10^3 \Omega$ to $2 \times 10^{19} \Omega$ Note: Resistance measurement accuracy is defined by the current range accuracy and voltage setting accuracy.
Setting voltage range (Accuracy)	0.1 to 100.0 V, 100 mV resolution, Accuracy: $\pm 0.1\%$ of setting $\pm 0.05\%$ f.s. 100.1 to 1000 V, 1 V resolution, Accuracy: $\pm 0.1\%$ of setting $\pm 0.05\%$ f.s. [SM7120 only] 1000 to 2000 V, 1 V resolution, Accuracy: $\pm 0.2\%$ of setting $\pm 0.10\%$ f.s.
Current Limiter	0.1 to 250.0 V: 5/ 10/ 50 mA, 251 to 1000 V: 5/ 10 mA, to 2000 V: 1.8 mA
Measurement time setting	Delay: 0 to 9,999 ms
Functions	Comparator, averaging, self-calibration, jig Capacity open correction, cable length correction, surface resistivity, volume resistivity, voltage monitor, contact check
Program function	10 types of discharge, charge, measure and measurement sequence discharge patterns can be programmed.
Display	LCD (8 lines of 30 characters), with backlight, High voltage warning indicator
Interfaces	USB, RS-232C, GP-IB, EXT I/O (NPN/PNP can be switched)
Power supply	100 to 240V AC, 50/60 Hz, 45 VA
Dimensions and mass	330 mm (12.99 in)W $\times$ 80 mm (3.15 in)H $\times$ 450 mm (17.72 in)D, 5.9 kg (208.1 oz)
Included accessories	Power cord $\times$ 1, Instruction manual $\times$ 1, CD-R (Communications command instruction manual, USB driver) $\times$ 1, EXT I/O male connector $\times$ 1, Short plug $\times$ 1

### Shared options with the SUPER MEGOHM METER SM7110, SM7120 and SM7420

Measurement leads							Humidity sensor
	PIN TYPE LEAD (RED) L2230 1 m (3.28 ft) length	CLIP TYPE LEAD (RED) L2232 1 m (3.28 ft) length	OPEN LEAD (RED) L2234 3 m (9.84 ft) length	PIN TYPE LEAD (BLACK) L2231 1 m (3.28 ft) length	CLIP TYPE LEAD (BLACK) L2233 1 m (3.28 ft) length	OPEN LEAD (BLACK) L2235 3 m (9.84 ft) length	
PC communication							Other
	RS-232C CABLE 9637 For the PC, 9pin - 9pin, cross, 1.8m (5.91 ft) length		GP-IB CONNECTOR CABLE 9151-02 2 m (6.56 ft) length				

# Super Megohm Testers (High Resistance Meters)

When connecting electrodes and shield boxes to SM7110/SM7120, note that CONVERSION ADAPTER Z5010 (special order) or a change of connectors is required. Please contact your local Hioki distributor for assistance.

## Options for Super megohm meters (for surface resistance or volume resistance measurement)

### SURFACE/VOLUME RESISTANCE MEASUREMENT ELECTRODE SM9001



Not CE Marked

- Electrodes compliant with the JIS C 2170 and IEC 61340-2-3 standards
  - Measurement voltage up to 1000 V, and measurement resistance up to  $10^{13} \Omega$
  - Surface and volume resistance of sheets and films can be measured just as they are without the need to cut samples
  - Measure the surface resistance of antistatic flooring and molded products
  - Measure the surface resistance of antistatic flooring and molded products
- \*When used with the SM-8200 series, measurement can take full advantage of the instrument's voltage and resistance ranges.

Dimensions:  $\phi$  100mm (3.94in)  $\times$  223mm (8.78in), Mass: 2.5 kg (88.2oz)  
Cable length: 1 m (3.28 ft)

Model No. (Order Code) **SM9001**  
**SM9002**

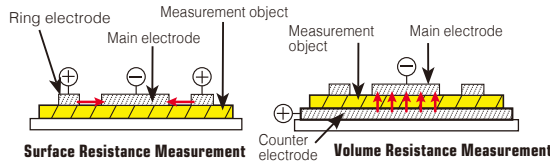

**Surface Resistance Measurement**

Measure the surface resistance between the main electrode and ring electrode of the main body electrode.

**Volume Resistance Measurement**

Measure the volume resistance of the sample sandwiched between the main electrode and counter-electrode.

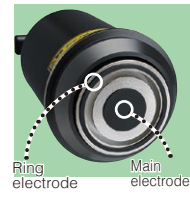

Ring electrode Main electrode

Not CE Marked

### VERIFICATION FIXTURE FOR SURFACE RESISTANCE MEASUREMENT SM9002

The SM9002 Verification Fixture for Surface Resistance Measurement (option) allows you to check the operation of the electrode to increase the reliability of measurement results.



### Electrode for surface resistance SME-8301



Not CE Marked

Surface resistance can be easily measured by simply pushing the electrode against the specimen. It measures surface resistance of anti-static related goods in combination of mainly Model SM-8213. Measure resistance up to  $10^{11} \Omega$ .

Dimensions:  $\phi$  60mm (2.36in)  $\times$  50mm (1.97in)  
Lead length 1m (3.28ft)

Model No. (Order Code) **SME-8301**

### Electrode for surface resistance SME-8302



Not CE Marked

Electrode for surface resistance of curved samples such as resin and rubber processed goods, TV cathode tubes or small samples. Surface resistance can be measured by pressing the rubber tips at the tip onto the sample. Measure electrodes up to  $10^{11} \Omega$  at 10 mm (0.39 in) intervals or greater.

An electrode distance: 4mm (0.16in)  
Dimensions:  $\phi$  40mm (1.57in)  $\times$  115mm (4.53in),  
Lead length 1m (3.28ft)

Model No. (Order Code) **SME-8302**

### Electrode for plate samples SME-8310



Not CE Marked

Sample of 100 mm (3.94 in) square by up to 8 mm (0.31 in) in thickness is measurable. The main electrode dia. is 50 mm (1.97 in) and inner & outer dia. of ring electrode are 70 mm (2.76 in) & 80 mm (3.15 in) respectively. Measurement voltage becomes "OFF" while the lid is open to ensure safety. A selector switch allows selection of voltage or surface resistivity.

\*A separately purchased interlock cable (DSM8104F) is required in order to use the product with the SM7110/SM7120, and DSM-8104.

Dimensions: 215mm (8.46in) W  $\times$  78mm (3.07in)H  $\times$  165mm (6.50in)D  
Lead length 75cm (2.46ft)

Model No. (Order Code) **SME-8310**

### Electrode for plates SME-8311

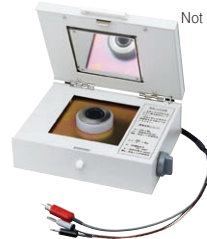

Not CE Marked

Sample of 40 to 100 mm (1.57 to 3.94 in) square by up to 8 mm (0.31 in) in thickness is measurable. The main electrode dia. is 19.6 mm (0.77 in) and inner & outer dia. of ring electrode are 24.1 mm (0.95 in) & 28.8 mm (1.13 in) respectively. Measurement voltage becomes "OFF" while the lid is open to ensure safety.

The fundamental specifications are the same as SME-8310.

\*A separately purchased interlock cable (DSM8104F) is required in order to use the product with the SM7110/SM7120, and DSM-8104.

Dimensions: 215mm (8.46in) W  $\times$  78mm (3.07in)H  $\times$  165mm (6.50in)D  
Lead length 75cm (2.46ft)

Model No. (Order Code) **SME-8311**

### Weight electrode SME-8320



Not CE Marked

This is an electrode for plate sample for use together with SME-8350 shield box. This electrode enables extremely easy measurement of surface resistivity and volume of sample with coarse surface such as carpets, etc. The main electrode dia. is 50 mm (1.97 in), and the ring electrode inner-dia. and outer-dia. are 70 mm (2.76 in) and 80 mm (3.15 in) respectively.

Photo is Combination with Shield box SME-8350

Model No. (Order Code) **SME-8320**

Note: Included: Banana plug  $\times$  2

### Shield box SME-8350



Not CE Marked

This is used as a sample accommodation box during measurement of a high-insulation resistance samples, or inductive or capacitive samples to perform electromagnetic shielding. When used in combination with mass electrode SME-8320, the electrode can be used as a counter electrode or a guard electrode. When measuring electronic components such as capacitors and transducers, external noise and leakage currents are prevented to ensure stable measurement.

\*A separately purchased interlock cable (DSM8104F) is required in order to use the product with the SM7110/SM7120, and DSM-8104.

Dimensions: 250mm (9.84in) W  $\times$  100mm (3.94in)H  $\times$  200mm (7.87in)D  
Lead length 80cm (2.62ft)

Model No. (Order Code) **SME-8350**

Note: Includes rubber sheet

### Standard resistor box SR-2



Not CE Marked

This is a resistor box for calibration of the super megohmmeters. Max. voltage is 1000 V DC and resistor value covers from 1 M to 10000 M $\Omega$  in 24 points.

Dimensions: 270mm (10.63in) W  $\times$  90mm (3.54in)H  $\times$  195mm (7.68in)D

Model No. (Order Code) **SR-2**

Note: Includes inspection data sheet

### Electrode for liquid samples SME-8330



Not CE Marked

Electrode for liquid samples which is electrically guarded. Total volume is 25 ml. Capacitance between main and counter electrode is approx. 45 pF. Electrode constant is approx. 500 cm (16.41 ft). Distance between both electrodes is 1 mm (0.04 in). Outer dia. is 36 mm (1.42 in), height is approx. 140 mm (5.51 in). Measure resistance up to  $10^{19} \Omega$  (at 1000 V) when used together with Model SM-8220. Electrodes compliant with the JIS C 2101 standard.

Included: Connection cable 60cm (1.97ft) length (Red) 0GA00029  $\times$  1 (Black) 0GA00030  $\times$  1

Dimensions:  $\phi$  36mm (1.42in)  $\times$  140mm (5.51in)

Model No. (Order Code) **SME-8330**

Note: Includes inspection data sheet

### Electrode for chip capacitor SME-8360



Not CE Marked

For measuring the resistance of tip capacitors, with adjustable jig from 0 to 11 mm (0 to 0.43 in). When connected to the meter by an interlock cable, measurement voltage becomes "OFF" while the lid is open to ensure safety.

The interlock cable must be modified in order to use the product with the SM-8220 series.

Dimensions: 200mm (7.87in) W  $\times$  52 mm (2.05in)H  $\times$  150mm (5.91in)D  
Lead length 85cm (2.79ft)

Model No. (Order Code) **SME-8360**

## 7-1/2 Digit DC Voltmeter for R&D to Production Lines

### PRECISION DC VOLTMETER DM7276, DM7275



- High-accuracy model with 1-year 9ppm Accuracy: DM7276
- Basic model with 1-year 20ppm Accuracy: DM7275
- Capacitance contact check (using built-in C-monitor)
- Supports global production with built-in variable power supply
- Built-in EXT I/O, LAN, and USB

Model No. (Order Code)	<b>DM7275-01</b>	
	<b>DM7275-02</b>	(Built-in GP-IB)
	<b>DM7275-03</b>	(Built-in RS-232C)
	<b>DM7276-01</b>	
	<b>DM7276-02</b>	(Built-in GP-IB)
	<b>DM7276-03</b>	(Built-in RS-232C)

Note: Measurement probes are not included. Purchase the probes appropriate for your application separately

#### Basic specifications (Accuracy guaranteed for 1 year)

	DM7275	DM7276
DC Voltage	100 mV ( $\pm 120.00000$ mV) to 1000 V ( $\pm 1000.0000$ V), 5 ranges	
Basic accuracy	10 V range: $\pm 0.0020\%$ rdg $\pm 12$ $\mu$ V	10 V range: $\pm 0.0009\%$ rdg $\pm 12$ $\mu$ V
Temperature	-10.0°C to 60.0°C (14.0°F to 140°F), combined with sensor Z2001: $\pm 0.5^\circ$ C (5.0°C to 35°C)	
Integration time	Integration time unit: PLC/ms (PLC setting: 0.02/0.2/1/10/100, ms setting: 1 ms to 9999 ms)	
Measurement support functions	Smoothing function, null, temperature compensation, scaling, over-range display, self-calibration, auto-hold, contact check	
Management support functions	Comparator, BIN, absolute value judgment, label display, statistics, measurement information, communication monitor, EXT. I/O TEST	
Contact check	Check signal: 10 mV rms, threshold value: 0.5 nF to 50 nF (Cannot use in the 100 V/1000 V ranges), Contact check integration time: 1 ms to 100 ms	
Interfaces	Standard: LAN (100BASE-TX), EXT. I/O, USB flash drive / USB device (USB2.0 Full-Speed) Optional: GP-IB (-02 type only) / RS-232C (-03 type only) / PRINTER (-03 type only)	
Power supply	100 to 240 V AC, 50/60 Hz, 30 VA	
Dimensions and mass	215 mm (8.46 in) W $\times$ 88 mm (3.46 in) H $\times$ 232 mm (9.13 in) D (-01 type); 2.3 kg (81.1 oz), (-02/-03 type); 2.4 kg (84.7 oz)	
Included accessories	Instruction manual $\times$ 1, power cord $\times$ 1, application disk (CD-R) $\times$ 1	

Options for the L9207-10

<b>TEST LEAD L9207-10</b> 90 cm (2.95 ft) length	<b>CONTACT PIN SET L4933</b> Attaches to the tip of the Test Lead L9207-10/ DT4911, L9206, 60V DC/ 30V AC	<b>SMALL ALLIGATOR CLIP SET L4934</b> Attaches to the tip of the L4932, L9207-10/ DT4911, L9206, CAT III 300V, CAT II 600V
---	---	--

Options for the L4930. Test Pin Set L4932 is required when using the Small Alligator Clip Set L4934.

<b>CONNECTION CABLE SET L4930</b> 1.2 m (3.94 ft) length	<b>EXTENSION CABLE SET L4931</b> Expands the length of the cable with banana plug, 1.5 m (4.92 ft) length	<b>TEST PIN SET L4932</b> Attaches to the tip of the banana plug cable, CAT IV 600V, CAT III 1000V	<b>SMALL ALLIGATOR CLIP SET L4934</b> Attaches to the tip of the L4932, L9207-10/DT4911, L9206, CAT III 300V, CAT II 600V	<b>ALLIGATOR CLIP SET L4935</b> Attaches to the tip of the banana plug cable, CAT IV 600V, CAT III 1000V	<b>BUS BAR CLIP SET L4936</b> Attaches to the tip of the banana plug cable, CAT III 600V	<b>GRABBER CLIP L9243</b> Attaches to the tip of the banana plug cable, CAT II 1000 V, 185 mm (7.28 in) length	<b>TEMPERATURE MEASUREMENT TEMPERATURE SENSOR Z2001</b> 1.75 m (5.74 ft) length
---	--	---	--	---	---	---	--

Options for PC communication

<b>USB CABLE (A-B) L1002</b> 1 m (3.28 ft) length	<b>GP-IB CONNECTOR CABLE 9151-02</b> 2 m (6.56 ft) length	<b>RS-232C CABLE 9637</b> For the PC, 9 pins - 9 pins, cross, 1.8m (5.91 ft) length	<b>LAN CABLE 9642</b> Straight Ethernet cable, supplied with straight to cross conversion adapter, 5 m (16.41 ft) length
--	--	--	---

## Introducing a New Digital, Multi-module DMM (Digital-Multi-Module) Station

### DMM STATION MR8990+MR8741, MR8740



Model No. (Order Code)	<b>MR8990</b>	(For the MR6000, MR8740, MR8847A, MR8827, and similar products)
	<b>MR8740</b>	(Max. 54ch, 864MW memory, main unit only)
	<b>MR8741</b>	(Max. 16ch, 256MW memory, main unit only)

### DMM STATION U8991+MR8740T

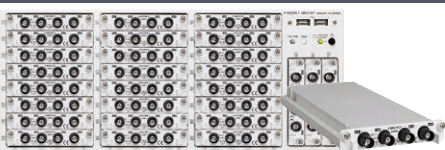

- Install in a Memory HiCorder to measure DC voltage with high accuracy and high resolution
- High-precision measurement for applications such as investigating minute voltage fluctuations in sensor output
- The MR8740T is packed with 27 units of U8991 and stores 108ch data at once
- Unlike standard multi-channel scan-type loggers, these instruments can perform simultaneous sampling

Model No. (Order Code)	<b>U8991</b>	(For the MR8740-50)
	<b>MR8740-50</b>	(Max. 108ch, 1GW memory, main unit only)

#### DMM Unit MR8990 Basic specifications (Accuracy guaranteed for 1 year)

Measurement functions	Install into Memory HiCorder MR6000/MR8847A/MR8827, MR8740/8741/MR8740T for use 2 channels of DC voltage measurement
Measurement ranges	100 mV range (5 mV/div): -120.0000 mV to 120.0000mV, 0.1 $\mu$ V resolution to 500 V range (50 V/div): -500.000 V to 500.000 V, 1 mV resolution, 5 ranges
Measurement accuracy	Basic accuracy: $\pm 0.01\%$ rdg $\pm 0.0025\%$ f.s.
Max. allowable input	500 V DC (upper limit voltage that can be applied between input terminals without damage)
Max. rated voltage to earth	300 V AC/DC (input and instrument are isolated; upper limit voltage that can be applied between input channels or between input channels and chassis without damage)
Max. sampling rate	2 ms (500 samples/s)

#### DMM Unit U8991 Basic specifications (Accuracy guaranteed for 1 year)

Measurement functions	Install into Memory HiCorder MR8740T for use 4 channels of DC voltage measurement
Measurement ranges	1 V f.s. range : -1.000 000 V to 1.000 000 V, 1 $\mu$ V resolution, to 100 V f.s. range : -100.0 000 V to 100.0 000 V, 100 $\mu$ V resolution, 3 ranges
Measurement accuracy	Basic accuracy: $\pm 0.02\%$ rdg $\pm 0.0025\%$ f.s.
Max. allowable input	100 V DC (upper limit voltage that can be applied between input terminals without damage)
Max. rated voltage to earth	100 V AC/DC (input and instrument are isolated; upper limit voltage that can be applied between input channels or between input channels and chassis without damage)
Max. sampling rate	20 ms (50 samples/s)

Note: It can not be used with the Digital Voltmeter Unit alone. Memory HiCorder body is required. Moreover, input code is not attached.

Other options refer to the detailed catalog

## Output the signal the recorder measured, which is ideal for abnormality simulation test

### ARBITRARY WAVEFORM GENERATOR UNIT **U8793**



- Output arbitrary waveform signals up to 2 channels
- Output problematic waveforms recorded with the Memory HiCorder up to 15 V
- Output customized arbitrary waveforms signals up to 15 V
- For use with Hioki Memory HiCorder series (cannot use with 8847 or MR8847)
- Built-in function generator and sweep function
- Isolated between unit and output, and between all channels

Model No. (Order Code) **U8793** (For the MR8847A and similar products)

Note: This module must be used with the Memory HiCorder. Output cords are not included. Please purchase them separately.

#### Basic specifications (Accuracy guaranteed for 1 year)

Output terminal	Number of channels: 2, SMB terminal (Output impedance: 1 Ω or less) Max. rated voltage to ground: 33 V rms AC or 70 V DC
Output voltage range	-10 V to 15 V (Amplitude setting range: 0 V to 20 V p-p, Setting resolution: 1 mV)
Max. output current	10 mA (Allowable load resistance: 1.5 kΩ or more)
Function generator	DC, Sine wave, Square wave, Pulse wave, Triangular wave, Ramp wave, Output frequency: 0 Hz to 100 kHz
Arbitrary waveform generator mode	Waveforms measured by MR8847A, etc., generated by Hioki Model 7075, PQ3198, or SF8000, CSV waveforms D/A refresh rate: 2 MHz (using 16-bit D/A)
Sweep function	Frequency, Amplitude, Offset, Duty (Pulse only)
Program function	Max. 128 steps (Number of loops for each step, Number of total loops)
Other	Self-test function (Voltage), External input/output control
Dimensions and mass	106 mm (4.17 in) W × 19.8 mm (0.78 in) H × 196.5 mm (7.74 in) D, 250 g (8.8 oz)
Included accessories	None



\* Main products are listed below. For more information, please see each product page.



### Related products

For options, please see the product catalog.

#### WAVEFORM GENERATOR UNIT **MR8790**



- Output sine waves (20 kHz max.) and DC voltage signals up to 4 channels per unit
- Output signals up to ±10V or 5mA
- For use with Hioki Memory HiCorder series (cannot use with 8847 or MR8847-01/-02/-03)
- Isolated between unit and output, and between all channels

Model No. (Order Code) **MR8790**

#### PULSE GENERATOR UNIT **MR8791**



- Output pulse waves, pattern waves up to 8 channels per unit (output signals of TTL level or open-collector)
- For use with Hioki Memory HiCorder series (cannot use with 8847 or MR8847-01/-02/-03)
- Isolated between unit and output (Not isolated between each channel (common ground))

Model No. (Order Code) **MR8791**

#### VIR GENERATOR UNIT **U8794**



- When used as an ECU testing device, generate simulated signals from various sensors, which is indispensable for testing electronic parts and maintaining equipment.
- 8 ch, DC voltage, DC current, resistance (simulated output)
- For use with Hioki Memory HiCorder MR8740T (MR8740-50) (cannot use with MR8740 or MR8741)
- Isolated between unit and output, and between all channels

Model No. (Order Code) **U8794** (Note: For the MR8740-50)

## Generate and Measure Signals Simultaneously

### DC SIGNAL SOURCE **SS7012**



- Improve stability and reduce calibration costs compared with the previous HIOKI model
- For instrumentation systems (4 - 20 mA) and loop testing
- Check temperature control equipment and electric distribution
- 8 types of thermocouples to test thermoelectric power generation
- Ideal for electrical device evaluating and routine maintenance of production equipment such as calibrators
- Use the max. 25 mA DC sink as an electric load

Model No. (Order Code) **SS7012**

Note: Use of the AC Adapter and/or rechargeable batteries and dedicated charger is recommended.

#### Basic specifications (Accuracy guaranteed for 1 year)

##### [Generation functions]

Circuit method	Bipolar sink and source
Constant Voltage	2.5 V: 0 to ±2,500 V (±0.03 % of setting ±300 μV, 100 μV resolution) 25 V: 0 to ±25,000 V (±0.03 % of setting ±3 mV, 1 mV resolution)
Constant Current	25 mA: 0 to ±25,000 mA (±0.03 % of setting ±3 μA, 1 μA resolution)
Thermoelectric power generation	K: at TC: 0 °C, -174.0 to 1372.0 °C (±0.05 % of setting ±0.5 °C, 0.1 °C resolution), Other types: E, J, T, R, S, B, N selectable
Thermoelectric power generation	K: at TC: RJ, -174.0 to 1372.0 °C (±0.05 % of setting ±1.0 °C, 0.1 °C resolution), Other types: E, J, T, R, S, B, N selectable
Standard resistance (Rs)	100 Ω (±0.2 Ω)
Automatic generation	Number of memory steps: 20, Interval time: 1 to 99 sec (at CV, CC, TC mode)

##### [Measurement functions]

Voltage	2.5 V: 0 to ±2,800 V (±0.03 % rdg ±300 μV, 100 μV resolution, 1 MΩ input resistance) 25 V: 0 to ±28,000 V (±0.03 % rdg ±3 mV, 1 mV resolution, 1 MΩ input resistance)
Current	25 mA: 0 to ±28,000 mA (±0.03 % rdg ±3 μA, 1 μA resolution, 25 Ω input resistance)
Temperature	-25.0 to 80.0 °C (±0.5 °C at 23 ±5 °C, 0.1 °C resolution, use with the RJ sensor 9184)
Sampling rate	Approx. 1.67 times/sec

Additional functions: Zero adjustment, Overflow display, USB communication, Monitor

Power supply	AC adapter 9445-02/-03 (100 to 240 V AC 50/60 Hz, 9 VA), Ni-MH battery HR6 × 4, 6 VA, (fully charged 2500 mAh Ni-MH batteries: 170 minutes continuous use), or LR6 (AA) alkaline battery × 4, 6 VA
Dimensions and mass	104 mm (4.09 in)W × 180 mm (7.09 in)H × 58 mm (2.28 in)D, 660 g (23.3 oz) (including LR6 × 4 batteries)
Included accessories	Input cord 9168 ×1, Test lead L9170-10 ×1, Fuse ×1, LR6 (AA) alkaline battery ×4, Instruction manual ×1

#### \*Bundled accessories



Commercially available rechargeable batteries (AA Ni-MH batteries ×4) may also be used to power the SS7012. Using locally purchased rechargeable batteries and dedicated battery chargers is recommended; however, HIOKI will not be able to guarantee operating time as different rechargeable batteries exhibit different power specifications per charge. The SS7012 cannot be used to recharge batteries.

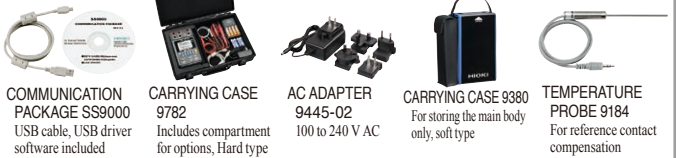



# Impulse Testers

## Diagnose the Insulation Quality and Deterioration of Rotor Windings while in Assembled State via Response Waveform Quantification

### IMPULSE WINDING TESTER ST4030A



- LAN
- USB 2.0
- GP-IB option
- RS-232C option
- CE

- Identify previously undetectable defects
- Detect waveforms with high precision (200 MHz high speed sampling × high 12-bit resolution)
- Identify single-fault turns via quantification of response waveforms into LC and RC values
- Diagnose defective insulation (pseudo-shorts) between motor windings by testing for microscopic partial discharges hidden in noise (option)

Model No. (Order Code) **ST4030A**

Note: The Discharge Detection Upgrade ST9000 is a factory option for the Impulse Winding Tester ST4030A. Please specify at time of order.

#### Basic specifications (Accuracy guaranteed for 1 year)

Measurement items	<ul style="list-style-type: none"> <li>Quantification (LC value, RC value) of the response waveform obtained when impulse voltage is applied, pass / fail judgment</li> <li>Waveform judgment using AREA value, Flutter, Laplacian etc.</li> <li>Equipped with dielectric breakdown voltage test function</li> </ul>
Applied voltage	100 V to 4200 V (Setting resolution: 10 V steps) Maximum applied energy: approx. 88 mJ
Testable inductance range	10 μH to 100 mH
Sampling	200 M / 100 M / 50 M / 20 M / 10 MHz, Resolution: 12 bits, Number of data: 1001 to 800 points (1000 point steps)
Voltage detection accuracy	[DC accuracy] ± 5% of setting, [AC band] 100 kHz: ± 1 dB
Determination method	LC · RC value judgment, waveform judgment, discharge judgment (when incorporating the ST9000)
Number of test condition tables	255 (test condition setting, judgment condition setting, master waveform)
Test time	About 60 ms (3000 V, 1 pulse, reference value at decision OFF)
Display	8.4-inch SVGA color TFT liquid crystal (800 × 600 dots), touch panel
Interface	Standard: EXT.I/O, USB host (memory), USB device (communication), LAN Optional: RS-232C (Z3001), GP-IB (Z3000)
Power supply	100 V to 240 V AC, 50/60 Hz, 80 VA max.
Dimensions and mass	215 mm (8.46 in)W × 200 mm (7.87 in)H × 348 mm (13.7 in)D, 6.7 kg (236.3 oz)
Included accessories	Power cord ×1, Instruction Manual ×1, Application disc ×1, Usage notes ×1

Safety Testing

Must specify when ordering

**DISCHARGE DETECTION UPGRADE ST9000**  
Highly accurate detection of insulation failure (pseudo short) between motor windings

**Input/Output cords**

**CLIP TYPE LEAD L2250**  
Max. rated voltage: 3300 V AC peak, 1.5 m (4.92 ft) length

**UNPROCESSED LEAD CABLE L2252**  
Max. rated voltage: 4200 V AC peak, 2 m (6.56 ft) length

Note: Effect of cable parasitic component  
Vibration waveform changes according to cable length. For consultation on special order products with cable capacity within a certain range, please contact your Hioki distributor.

**PC communication**

**GP-IB INTERFACE Z3000**

**GP-IB CONNECTOR CABLE 9151-02**  
2 m (6.56 ft) length

**RS-232C INTERFACE Z3001**

**RS-232C CABLE 9637**  
9 pin - 9 pin, cross, 1.8 m (5.91 ft) length

## High Accuracy Detection of Pseudo Shorts

### DISCHARGE DETECTION UPGRADE ST9000

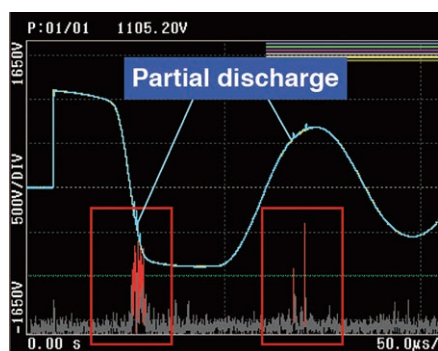

- Option additional function for ST4030A
- Detect microscopic partial discharges obscured by noise to determine defective insulation (pseudo-shorts)
- HIOKI original filter \* (\*Noise components within the high frequency components appearing within the entire response waveform are removed to extract only the partial discharge component in order to make a pass/fail determination. Jointly developed with Aisin AW Co., Ltd.)
- Peripheral equipment (antenna for discharge detection etc.) not required to easily detect discharge

Model No. (Order Code) **ST9000** (Factory option firmware for the ST4030A)

Note: The Discharge Detection Upgrade ST9000 is a factory option for the Impulse Winding Tester ST4030A. Please specify at the time of order.

#### Basic specifications

Measurement functions	Determine discharge
Compatible models	ST4030A

## Leak Current Measurement, an Essential Part of Electrical Safety (for medical-use electrical devices)

### LEAK CURRENT HiTESTER ST5540



USB 1.1

RS-232C

CE

3 Year Warranty

- Compliance with IEC 60601-1:2005 Ed 3.0, JIS T 0601-1:2012 for medical-use electrical devices and essential to electrical safety (\*Starting on June 1, 2012, medical electrical equipment sold in the EU must comply). Model ST5540 comply with IEC 60601-1:2005+ A1:2012 (Ed 3.1), and IEC 62353 of 2017
- Compliance with Electrical Appliances and Materials Safety Act, JIS, IEC, and UL standards for general-use electrical devices
- Uninterrupted polarity switching function dramatically reduces cycle time
- Support for rated currents up to 20 A gives the instrument more than adequate capability for testing products designed to comply with new standards
- Touch panel features simple, interactive operation
- Communications functionality and external I/O support allow automatic testing on production lines

Model No. (Order Code) **ST5540** (For medical-use and electrical devices)

Note: Always use an isolation transformer when measuring leak current for medical-use electrical devices. The ST5540 does not include an isolation transformer. When measuring medical-use electrical devices, use a step-up isolation transformer or similar component operating at 110% of the rated supply voltage as the power supply for the device under test.

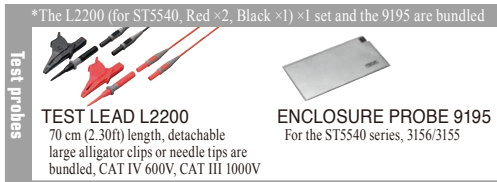

\*The L2200 (for ST5540, Red x2, Black x1) x1 set and the 9195 are bundled

**TEST LEAD L2200**  
70 cm (2.30ft) length, detachable large alligator clips or needle tips are bundled, CAT IV 600V, CAT III 1000V

**ENCLOSURE PROBE 9195**  
For the ST5540 series, 3156/3155

#### Basic specifications (Accuracy guaranteed for 1 year)

Measurement methods	Measurement of voltage drop across body simulated resistance points, Calculation and display of current values, True rms measurement, Measurement unit floats relative to instrument ground.
Measurement modes	Leak current measurement, voltage measurement, safety conductor current measurement
Standards compliance (NW: Body simulated resistance)	[NW-A] • Electrical Appliances and Materials Safety Act [NW-B1] • Medical electrical equipment: IEC 60601-1:1988+ A1:1993+ A2:1995, JIS T 0601-1:1999 [NW-B2] • Medical electrical equipment: IEC 60601-1:2005+ A1:2012, JIS T 0601-1:2012 and complement 1:2014, IEC 62353 [NW-C] • Measurement of touch current and protective conductor current: IEC 60990:2016 • Electrical equipment for measurement, control, and laboratory use: IEC 61010-1:2010+ A1:2016 • Information technology equipment: IEC60950-1:2005+ A1:2009+ A2:2013 • Audio, video and similar electronic apparatus: IEC 60065:2014 • Personnel Protection Systems for EV: UL 2231-1:2012 (Amended 2016), UL-2231-2:2012 (Amended 2016) [NW-D] • For UL: UL 1492:1996 (Amended 2013) [NW-G] • Electrical equipment for measurement, control, and laboratory use; current measurement circuits in damp conditions: IEC 61010-1:2010+ A1:2016
Leak current measurement	Ground leak current, 3 types of contact current, 7 types of patient leak current, patient measurement current, 4 types of total patient leak current, free current measurement, 3 types of enclosure leak current
Measurement current	DC, AC (true rms, 0.1 Hz to 1 MHz), AC+DC (true rms, 0.1 Hz to 1 MHz), AC peak (15 Hz to 1 MHz)
Measurement ranges	DC / AC / AC+DC mode: 50.00 mA/ 5.000 mA/ 500.0 μA/ 50.00 μA AC peak mode: 75.0 mA/ 10.00 mA/ 1.000 mA/ 500.0 μA
Measurement accuracy (current measurement)	DC measurement: ±2.0% rdg ±6 dgt (typ.) AC / AC+DC measurement: ±2.0% rdg ±6 dgt (15 Hz to 100 kHz, typ.) AC peak measurement: ±2.0% rdg ±6 dgt (15 Hz to 10 kHz, typ.)
Interfaces	External I/O, medical device relay output, USB 1.1 (communications), RS-232C
Functionality	110% voltage application, automatic test, data storage for 100 target devices, clock, data backup, printed output (optional), etc.
Power supply	100/120/220/240 V AC (specify at time of order), 50/60 Hz, 30 VA rated power
Target device power supply input	100 to 250 V AC, 50/60 Hz Rated current input from terminal block: 20 A
Target device power supply output	Output from terminal block: 20 A Output from outlet: 15 A
Dimensions and mass	320 mm (12.60 in)W × 110 mm (4.33 in)H × 253 mm (9.96 in)D, 4.5 kg (158.7 oz)
Included accessories	Test lead L2200 (for ST5540, Red x2, Black x1) x1 set, Enclosure probe 9195 x1, Power cord x3, Spare fuse for measurement line x1, Instruction manual x1, CD-ROM x1

## Leak Current Measurement, an Essential Part of Electrical Safety (for electrical devices)

### LEAK CURRENT HiTESTER ST5541



USB 1.1

RS-232C

CE

3 Year Warranty

- Compliance with Electrical Appliances and Materials Safety Act, JIS/IEC/UL standards
- Uninterrupted polarity switching function dramatically reduces cycle time
- Support for rated currents up to 20 A gives the instrument more than adequate capability for testing products designed to comply with new standards
- Touch panel features simple, interactive operation
- Communications functionality and external I/O support allow automatic testing on production lines

Model No. (Order Code) **ST5541** (For electrical devices)

Note: For applications involving leak current measurement of medical-use electrical devices, use the ST5540.

#### Basic specifications (Accuracy guaranteed for 1 year)

Measurement methods	Measurement of voltage drop across body simulated resistance points, Calculation and display of current values, True rms measurement, Measurement unit floats relative to instrument ground.
Measurement modes	Leak current measurement, voltage measurement, safety conductor current measurement
Standards compliance (NW: Body simulated resistance)	[NW-A] • Electrical Appliances and Materials Safety Act [NW-C] • Measurement of touch current and protective conductor current: IEC 60990:2016 • Electrical equipment for measurement, control, and laboratory use: IEC 61010-1:2010+ A1:2016 • Information technology equipment: IEC60950-1:2005+ A1:2009+ A2:2013 • Audio, video and similar electronic apparatus: IEC 60065:2014 • Personnel Protection Systems for EV: UL 2231-1:2012 (Amended 2016), UL-2231-2:2012 (Amended 2016) [NW-D] • For UL: UL 1492:1996 (Amended 2013) [NW-G] • Electrical equipment for measurement, control, and laboratory use; current measurement circuits in damp conditions: IEC 61010-1:2010+ A1:2016
Leak current measurement	Ground leak current, 3 types of contact current, free current measurement, 3 types of enclosure leak current
Measurement current	DC, AC (true rms, 15 Hz to 1 MHz), AC+DC (true rms, 15 Hz to 1 MHz), AC peak (15 Hz to 1 MHz)
Measurement ranges	DC / AC / AC+DC mode: 50.00 mA/ 5.000 mA/ 500.0 μA/ 50.00 μA AC peak mode: 75.0 mA/ 10.00 mA/ 1.000 mA/ 500.0 μA
Measurement accuracy (current measurement)	DC measurement: ±2.0% rdg ±6 dgt (typ.) AC / AC+DC measurement: ±2.0% rdg ±6 dgt (15 Hz to 100 kHz, typ.) AC peak measurement: ±2.0% rdg ±6 dgt (15 Hz to 10 kHz, typ.)
Interfaces	External I/O, USB 1.1 (communications), RS-232C
Functionality	Automatic test, data storage for 100 target devices, clock, data backup, printed output (optional), etc.
Power supply	100/120/220/240 V AC (specify at time of order), 50/60 Hz, 30 VA rated power
Target device power supply input	100 to 250 V AC, 50/60 Hz Rated current input from terminal block: 20 A
Target device power supply output	Output from terminal block: 20 A Output from outlet: 15 A
Dimensions and mass	320 mm (12.60 in)W × 110 mm (4.33 in)H × 253 mm (9.96 in)D, 4.5 kg (158.7 oz)
Included accessories	Test lead L2200 (Red x1, Black x1) x1 set, Enclosure probe 9195 x1, Power cord x3, Spare fuse for measurement line x1, Instruction manual x1, CD-ROM x1

#### ST5540, ST5541 shared options

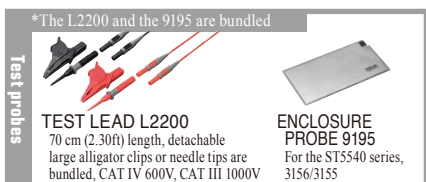

\*The L2200 and the 9195 are bundled

**TEST LEAD L2200**  
70 cm (2.30ft) length, detachable large alligator clips or needle tips are bundled, CAT IV 600V, CAT III 1000V

**ENCLOSURE PROBE 9195**  
For the ST5540 series, 3156/3155

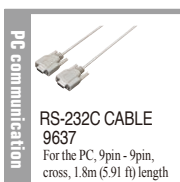

PC communication

**RS-232C CABLE 9637**  
For the PC, 9pin - 9pin, cross, 1.8m (5.91 ft) length

## ■ ST5540, ST5541 List of functions

	Item	ST5540	ST5541
Network	Network A (Electrical Appliances and Materials Safety Act)	✓	✓
	Network B (Medical-use electrical devices)	✓	-
	Network C (IEC 60990)	✓	✓
	Network D (UL)	✓	✓
	Network E (General-purpose 1)	✓	✓
	Network F (General-purpose 2)	✓	✓
	Network G (IEC 61010-1)	✓	✓
Major functions	Power on polarity switching function	✓	✓
	Rated current 20 A	✓	✓
	Function for checking for blown fuses	✓	✓
	Frequency band switching	✓	-
	110% voltage output terminal (T3 terminal)	✓	-
	S10, S12, S13, E terminal	✓	-

## ■ ST5540, ST5541 List of functions

	Item	ST5540	ST5541
Testing leakage current mode	Earth leakage current	✓	✓
	Touch current	✓	✓
	Patient auxiliary current	✓	-
	Patient leakage current	✓	-
	Total patient leakage current	✓	-
	Free current	✓	✓
	Enclosure - Earth leakage current	✓	✓
	Enclosure - Enclosure leakage current	✓	✓
	Enclosure - Line leakage current	✓	✓
	Patient leakage current I	✓	-
	Patient leakage current II	✓	-
	Patient leakage current III	✓	-

## For Multi-point, High-voltage Automatic Testing and Automation of Insulation and Dielectric Strength Testing

### HIGH VOLTAGE SCANNER 3930

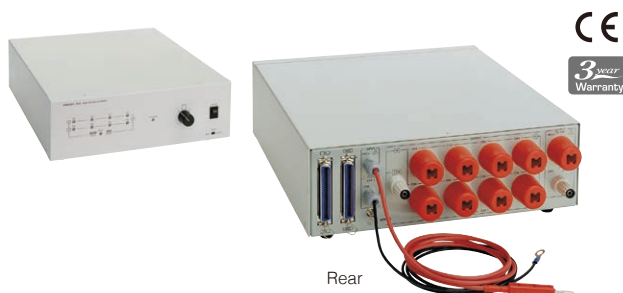

- Output of the input high voltage from a user-selected channel
- 8 ch per unit (single mode), with up to 32 ch (4 connected units)
- Isolated high-voltage I/O, control signal lines, and power supply
- Control using the 3153 program function or with a standard sequencer

Model No. (Order Code) **3930** (For the 3153 and similar products)

### ■ Basic Specifications

Operation modes	Multi-mode: Scanning of user-selected points for high 4 ch / low 4 ch Single mode: Common scan of high 8 ch - common
Rated voltage used	5 kV AC / 5 kV DC
Operation indications	Lamps light up when power is supplied and when a specified channel is operating
[Relay area]	
Max. open and closed voltage	5000 V DC, 5000 V AC
Max. open and closed current	1.0 A (open and closed capacity: 50 W)
Contact point indirect contact resistance	500 mΩ or less, with 1 mA AC
Contact point max. capacity	50 W
Time	Operation time: 6 ms or less, Recovery time: 6 ms or less
Power supply	VSCV 24 V DC, ±10% (applied using the control signal input connector), 12 VA max.
Dimensions and mass	316 mm (12.44 in)W × 100 mm (3.94 in)H × 350 mm (13.78 in)D, 4.2 kg (148.1 oz)
Included accessories	Control input connector connection cable ×1, H.V. Test lead 9615-01 (red) ×8, H.V. Test lead (black) ×1, Grounding cable ×1, Instruction manual ×1



## Control insulation, dielectric strength, protective continuity, and leak current testing from a PC

### SAFETY TEST DATA MANAGEMENT SOFTWARE 9267

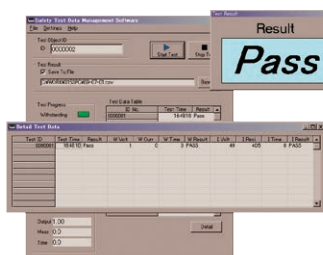

- Control the ST5520\*/ST5540 as well as the 3153/3154/3156/3157, 3174, and other instruments from a computer

\*Control of the ST5520 is subject to certain limitations.

- Perform automatic insulation and dielectric strength testing of up to 32 points with the High Voltage Scanner 3930

Model No. (Order Code) **9267**

### ■ Basic Specifications

Compatible models	ST5520*, ST5540/ST5541, 3153, 3154, 3156, 3157, 3158, 3159, 3174, 3332, 3333, 3334, and PLCs from various manufacturers (for connection switching) *Control of the ST5520 is subject to certain limitations.
Supplied media	CD-R ×1
Operating environment	Windows 10 (32-/64-bit), Windows 7 (32-/64-bit), Vista (32-bit), XP/2000
Test types	Insulation and dielectric strength, protective continuity, leak current, energization
Recording data	Recording of test results (measured values) as a text file (CSV format)
Interface	RS-232C (USB communication, or RS-232C with ST5540, ST5541)

This dedicated application allows you to control and take measurements through insulation testing, dielectric strength testing, protective continuity testing, leak current testing, and energization testing and to record test results as a text file.

## Ensure insulation resistance testing in the battery production processes

### BATTERY INSULATION TESTER BT5525

**New**



LAN

USB2.0

RS-232C

CE

3 Year Warranty

- Ideal for battery production lines
- BDD function for detecting minuscule short-circuits caused by contamination
- Stable insulation resistance testing even in noisy environments
- Contact check function (Prevents errors due to poor contact)
- High cost performance thanks to accessible pricing, high-speed testing, and compact footprint
- Contact check function reduces the number of false negatives caused by equipment issues

Model No. (Order Code) **BT5525**

Note: The instrument is not able to perform measurement by itself. Please purchase optional test leads separately as appropriate for your measurement application. The LOW terminal is a dedicated HIOKI connector, so only our optional L2131 or L2133 can be connected.



#### Basic specifications (Accuracy guaranteed for 1 year)

Main functions	Insulation resistance test, Break Down Detect (BDD) function, Contact check function
Output specifications	Output voltage: 25 V to 500 V, Setting resolution 1 V Charging current (current limit function): 50 $\mu$ A to 50 mA*1*2*3, minimum setting resolution 10 $\mu$ A Short-circuit current: 60 mA or less Discharge current: 40 mA or greater
Measurement specifications	Resistance value display range: 0.050 M $\Omega$ to 9999 M $\Omega$ Resistance range: 2 M $\Omega$ , 20 M $\Omega$ , 200 M $\Omega$ , 2000 M $\Omega$ , AUTO
Basic specifications	$\pm 1.5\%$ rdg. $\pm 2$ dgt. $25 \text{ V} \leq V < 100 \text{ V}$ [0.05 M $\Omega$ to 2 M $\Omega$ ], $100 \text{ V} \leq V \leq 500 \text{ V}$ [0.2 M $\Omega$ to 20 M $\Omega$ ] Test time: 0.050 s to 999.999 s, OFF Comparator delay time: 0.001 s to 999.999 s, AUTO Display update speed: 1 PLC Sampling time: 1 PLC to 100 PLC
Time specifications	Panel save function: Saves up to 15 sets of measurement conditions
Memory functions	Measured value memory function: Saves up to 999 measured values in the instrument's internal memory Test modes: Continuous test, PASS STOP, FAIL STOP
Judgment functions	Comparator function: UPPER_FAIL: Measured value > upper limit value PASS: Upper limit value $\geq$ measured value $\geq$ lower limit value LOWER_FAIL: Measured value < lower limit value
Various functions	Break Down Detect function (BDD): Detecting minuscule insulation defects caused by contamination Contact check function: 2-terminal capacitance measurement method Automatic data output function: Automatic output of measurement results via communication interface after completion of test Command monitor function: Screen display of commands being sent and received External I/O monitor function: Screen display of output signal ON/OFF and input signal status Analog output function: Converts measured values to 0 to 4 V DC and outputs
Interfaces	USB, LAN, RS-232C, EXT. I/O
Power supply	100 V to 240 V AC
Maximum rated power	100 VA
Dimensions and mass	Approx. 215 mm (8.46 in) W $\times$ 80 mm (3.15 in) H $\times$ 306.5 mm (12.07 in) D (excluding protruding parts), Approx. 2.8 kg (98.8 oz)
Included accessories	Power cord $\times$ 1, EXT. I/O male connector $\times$ 1, EXT. I/O connector cover $\times$ 1, EXT. I/O interlock cancellation jig $\times$ 1, Startup Guide $\times$ 1

\*1: Constraints involving the output generator will result in an error, making measurement impossible, if a capacitive load of approximately 50  $\mu$ F or greater is connected while using a current limit setting of 5.1 mA or greater.

\*2: When using a current limit setting of 5.1 mA or greater, measurement will be forcibly stopped if the output voltage is not at least 20 V at 200 ms after the start of measurement. Measurement will be possible 1 s after forcibly stopped.

\*3: If the set current limit value is from 5.1 mA to 50.0 mA, the current will be limited to 5 mA after the output voltage reaches the set voltage.

## Industry's Fastest Testing Speed

### INSULATION TESTER ST5520



RS-232C

CE

3 Year Warranty

- Rapidly assess in as fast as 50 ms
- Quick discharge of residual voltage
- Freely configurable test voltage (Set from 25 V to 1000 V, 1 V resolution)
- Contact check function (Prevents errors due to poor contact)
- Short-circuit check function (Stops potential defects from reaching the market)
- Ideal for battery production lines

Model No. (Order Code) **ST5520** (Built-in external I/O output)  
**ST5520-01** (Built-in BCD output)

Note: The ST5520 and ST5520-01 cannot be operated alone. Please select and purchase the optional test leads to accommodate your application.

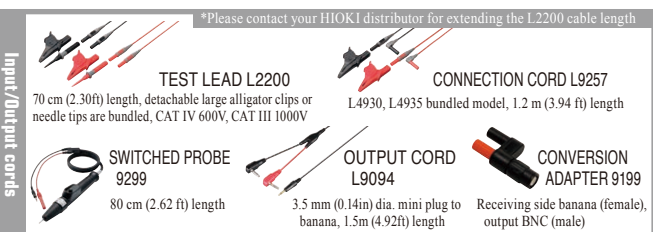

#### Basic specifications (Accuracy guaranteed for 1 year)

Measurement items	Insulation resistance (Applied DC voltage method) (Measurement range: AUTO/MANUAL setting is possible)
Testing voltage	$25 \text{ V} \leq V < 100 \text{ V}$ (2.000/20.00/200.0 M $\Omega$ ), $100 \text{ V} \leq V < 500 \text{ V}$ (2.000/20.00/200.0/2000 M $\Omega$ ), $500 \text{ V} \leq V \leq 1000 \text{ V}$ (2.000/20.00/200.0/4000 M $\Omega$ )
Basic accuracy	$\pm 2\%$ rdg. $\pm 5$ dgt. $25 \text{ V} \leq V < 100 \text{ V}$ [0 to 20 M $\Omega$ ], $100 \text{ V} \leq V < 500 \text{ V}$ [0 to 20 M $\Omega$ ], $500 \text{ V} \leq V \leq 1000 \text{ V}$ [0 to 20 M $\Omega$ ]
Measurement speed	Fast: 30 ms/time, Slow: 500 ms/time (selectable)
Display	LCD (service life: 100,000 hours), 4-level backlight
Internal memory	Saved items: rated measurement voltage, comparator upper limit /lower limit values, test mode, beep sound to distinguish the result, test time, response time, resistance range, measurement speed Memory capacity: up to 10 items (can be saved/loaded)
Comparator setting	UPPER_FAIL: Measured value $\geq$ upper limit value PASS: Upper limit value > measured value > lower limit value LOWER_FAIL: Measured value $\leq$ lower limit value
Judgement process	Beep sound, PASS / U.FAIL/L. FAIL: light up on LED display. When UL_FAIL, U.FAIL / L.FAIL light up simultaneously, EXT.I/O output, judgement result can be obtained via RS-232C
Test duration	Definition of test duration: Test duration = Response time + Measurement time Function: Set the time from voltage application until pass/fail assessment Configuration range: 0.045 s to 999.999 s (0.001 s resolution)
Response time timer	After the start of the test, comparator judgment operation can be prohibited until a set interval from 0.005 sec. to 999.999 sec. (at 0.001 sec. resolution) has passed.
Analog output	DC +4 V f.s.
Interface	RS-232C (standard), External I/O (External control input, Judgment result) BCD output (ST5520-01 only)
Power supply	100 to 240 V AC, 50/60 Hz, 25 VA max.
Dimensions and mass	215 mm (8.46 in)W $\times$ 80 mm (3.15 in)H $\times$ 166 mm (6.54 in)D, 1.1 kg (38.8 oz)
Included accessories	Instruction Manual $\times$ 1, Power cord $\times$ 1, EXT. I/O Connector $\times$ 1, Connector Cover $\times$ 1



## Ensure Insulation and Withstand Voltage with Contact Check

### AC AUTOMATIC INSULATION/WITHSTANDING HITESTER 3174



RS-232C



- Continuous testing of insulation (500/1000 V) and withstand voltage (100 VA transformer capacity)
- Full remote operation when used in combination with the Safety Test Data Management Software 9267
- Save up to 8 test settings each for the withstanding and insulation testing modes
- Precise test voltage without power voltage dependency is generated using the PWM method

Model No. (Order Code) **3174** (Insulation/Withstanding Voltage [AC])

Note: To perform contact checks, please purchase another High Voltage Test Lead 9615 set separately.

#### Basic specifications (Accuracy guaranteed for 1 year)

##### [Withstanding test section]

Testing voltage	0.2 V AC to 5.00 kV AC
Voltage setting	Digital setting, Setting resolution: 0.01 kV
Waveform/Frequency	Sine wave (Distortion ratio 5 % or less at no load), 50/60 Hz selectable
Current measurement	0.01 mA to 20.0 mA, True RMS rectified (digital display)
Measurement range	10 mA (0.01 mA resolution), 20 mA (0.1 mA resolution)
Voltage meter	Accuracy: $\pm 1.5\%$ rdg (1000 V or more), $\pm 15\%$ V (less than 1000 V), True RMS rectified
Judgment function	Window comparator method (Digital setting)

##### [Insulation test section]

Testing voltage	500 V DC, 1000 V DC
Unloaded voltage	1 to 1.2 times rated voltage
Rated testing current	1 to 1.2 mA, Shorted current: 4 to 5 mA (at 500 V), 2 to 3 mA (at 1000 V)
Measurement range, Accuracy	0.5 M $\Omega$ to 999 M $\Omega$ (at 500 V), and 1 M $\Omega$ to 999 M $\Omega$ (at 1000 V); $\pm 4\%$ rdg, 1000 M $\Omega$ to 2000 M $\Omega$ : $\pm 8\%$ rdg
Judgment function	Window comparator method (Digital setting)

##### [Timer section] \*Test times may differ from set timer times depending on the load.

Setting range	0.3 to 999 s
Ramp, Delay	Testing voltage ramp-up, or down, Insulation test delay: 0.1 to 99.9 s

##### [General section]

Functions	Saving 8 testing conditions, hold, buzzer, contact check
Monitor function	Output voltage, detected current, insulation resistance, Refresh rate: 2 times/s
Power supply	100 to 240 V AC, (50/60 Hz), 200 VA max.
Dimensions and mass	320 mm (12.60 in)W $\times$ 155 mm (6.10 in)H $\times$ 395 mm (15.55 in)D, 15 kg (32.9 lb)
Included accessories	H.V. Test lead 9615 (high voltage side and return, 1 each) $\times$ 1, Power cord $\times$ 1, Instruction manual $\times$ 1, Disconnection prevention plate $\times$ 1

\*The 9615 is bundled

Input/Output cords



H.V. TEST LEAD 9615  
Red, Black each 1, 1.5 m  
(4.92 ft) length



REMOTE CONTROL BOX (SINGLE) 9613  
For Start/Stop control, 1.5m  
(4.92 ft) cord length



REMOTE CONTROL BOX (DUAL) 9614  
For Start/Stop control, 1.5m  
(4.92 ft) cord length

PC communication



SAFETY TEST DATA MANAGEMENT SOFTWARE 9267  
For PC control application software



RS-232C CABLE 9637  
For the PC, 9pin - 9pin, cross, 1.8m (5.91 ft) length

## All-in-one Model that Combines Withstand Voltage and Insulation Resistance (AC/DC)

### AUTOMATIC INSULATION / WITHSTANDING HITESTER 3153



GP-IB

RS-232C



- Programmable insulation (50 to 1200 V DC) and dielectric strength (AC/DC) testing
- Program up to 32 files of test types, test points (50 steps), and measurement settings
- Optional scanner for multipoint automatic testing
- Uses the PWM method to generate accurate test voltages that do not depend on the supply voltage
- Ramp timer function for increasing or decreasing the applied voltage during dielectric strength testing at user-specified times

Model No. (Order Code) **3153** (Insulation, AC/DC Withstanding Voltage)

#### Basic specifications (Accuracy guaranteed for 1 year)

##### [Withstanding test section]

Testing voltage	0.2 kV to 5.00 kV AC, 500 VA (max. 30 minutes), 0.2 kV to 5.00 kV DC, 50 VA (continuance)
Voltage setting	Digital setting (0.01 kV setting resolution)
Waveform/Frequency	Sine wave (5% or less distortion, unloaded), 50/60 Hz selectable
Current measurement	0.01 mA to 100.0 mA, Average rectified display (Digital)
Measurement range	10 mA (0.01 mA resolution), 100 mA (0.1 mA resolution)
Voltmeter	Digital: accuracy $\pm 1.5\%$ f.s. (f.s.=5.00 kV) (Average rectified display)
Decision method	Window comparison (digital settings)

##### [Insulation test section]

Rated testing voltage	50 to 1,200 V DC (in 1 V steps)
Rated testing current	1 mA, Short-circuit current: 200 mA or less
Measurement range / accuracy	0.10 to 9999 M $\Omega$ , 4 ranges, $\pm 4\%$ rdg (representative values for 0.5 M $\Omega$ to 1,000 M $\Omega$ )
Decision method	Window comparison (digital settings)

##### [Timer section] \*Test times may differ from set timer times depending on the load.

Setting range	0.3 to 999 s
Ramp, Delay	Testing voltage ramp-up, or down, Insulation test delay: 0.1 to 99.9 s

##### [General section]

Functions	Program up to 32 files of 50 step test settings. 10 sets each of dielectric strength and insulation test settings, hold, buzzer
Monitor functions	Output voltage, detected current, measured resistance, Refresh rate: 2 times/s
Power supply	100 to 120 V, 200 to 240 V AC, (50/60 Hz), 1000 VA max.
Dimensions and mass	320 mm (12.60 in)W $\times$ 155 mm (6.10 in)H $\times$ 480 mm (18.9 in)D, 18 kg (39.7 lb)
Included accessories	H.V. Test lead 9615 (high voltage side and return, 1 each) $\times$ 1, Power cord $\times$ 1, Instruction manual $\times$ 1, Spare fuse $\times$ 1

\*The 9615 is bundled

Input/Output cords



H.V. TEST LEAD 9615  
Red, Black each 1, 1.5 m  
(4.92 ft) length



REMOTE CONTROL BOX (SINGLE) 9613  
For Start/Stop control, 1.5m  
(4.92 ft) cord length



REMOTE CONTROL BOX (DUAL) 9614  
For Start/Stop control, 1.5m  
(4.92 ft) cord length

PC communication



SAFETY TEST DATA MANAGEMENT SOFTWARE 9267  
For PC control application software



RS-232C CABLE 9637  
For the PC, 9pin - 9pin, cross, 1.8m (5.91 ft) length



GP-IB CONNECTOR CABLE 9151-02  
2 m (6.56 ft) length

Other



HIGH VOLTAGE SCANNER 3930  
Automatic multipoint testing of high voltages

## Protective Ground Tester Indispensable for Standards Certification

### AC GROUNDING HIESTER 3157



**GP-IB**  
option

**RS-232C**  
option



#### Basic specifications (Accuracy guaranteed for 1 year)

Basic functions	AC 4-terminal method resistance measurement
Display	Fluorescent tube (digital display)
Current setting range	3.0 A to 31.0 A AC (0.1 A resolution), into 0.1Ω load
Max. output power	130 VA (at output terminals)
Open-terminal voltage	Max. 6 V AC
Generator frequency	50 Hz or 60 Hz sine wave (selectable)
Resistance measurement	0 to 1.800 Ω (0.001 Ω resolution), Accuracy: ±2% rdg ±4 dgt after zero-adjust
Voltage measurement	0 to 6.00 V AC (single range 0.01 V resolution), Accuracy: (1 % rdg +5 dgt)
Monitor section	0 to 35.0 A AC/ 0 to 6 V AC, Refresh rate: 2 times/s
Timer display	Counts down time after start until preset time, Shows elapsed time after start
Timer setting	0.5 s to 999 s
Comparator	PASS/FAIL evaluation using preset upper/lower limit, buzzer sound, signal output
Memory function	Max. 20 settings (with save/load)
Interfaces	EXT I/O, EXT SW, GP-IB or RS-232C (option)
Power supply	100 to 120 V/200 to 240 V AC (switching, 50/60 Hz)
Dimensions and mass	320 mm (12.60 in)W × 90 mm (3.54 in)H × 263 mm (10.35 in)D, 7 kg (246.9 oz)
Included accessories	Power cord ×1, Instruction Manual ×1, Spare fuse (inlet) ×1, Shorting bar ×2

- Easily perform protective continuity testing in compliance with international safety standards and laws
  - 1) Protective continuity resistance measurement for medical devices and general electrical devices
  - 2) Ground connectivity testing when installing electrical machine tools and distribution panels
  - 3) Testing of protective grounding and isopotential grounding work for medical equipment
  - 4) Evaluation of contact status using large currents
- Feedback control system that is capable of applying a stable current even with a fluctuating load
- Soft-start function that checks the connection to the device under test before applying the current

Model No. (Order Code) **3157-01** (100-120 / 200-240 VAC switching)

Note: This instrument is not capable of performing measurement by itself. Please purchase two Current probe 9296 units or one Current probe 9296 and one Current apply probe 9297, depending on your measurement application.

Input/output cords				
	REMOTE CONTROL BOX (SINGLE) 9613 For Start/Stop control, 1.5m (4.92 ft) cord length	REMOTE CONTROL BOX (DUAL) 9614 For Start/Stop control, 1.5m (4.92 ft) cord length	CURRENT PROBE 9296 Alligator clip, 1.45m (4.76 ft) length	CURRENT APPLY PROBE 9297 With switch, 1.48m (4.86 ft) length

PC communication			RS-232C INTERFACE 9593-03 For the 3157-01, built in type
	SAFETY TEST DATA MANAGEMENT SOFTWARE 9267 For PC control application software	GP-IB CONNECTOR CABLE 9151-02 2 m (6.56 ft) length	GP-IB INTERFACE 9518-02 For the 3157-01, built in type

Safety Testing

# Power Analyzers

Providing the ultimate power analyzer for use by all engineers pursuing power conversion efficiency

## POWER ANALYZER PW8001

New



USB 3.0

LAN

GP-IB

RS-232C

True RMS



■ Basic specifications (Accuracy guaranteed for 6 months, multiply the 6-month accuracy reading error by 1.5 to obtain the 1-year accuracy.)

Measurement lines	1-phase-2-wire, 1-phase-3-wire, 3-phase-3-wire, 3-phase-4-wire
No. of input units	Max. 8 units (mix and match)
Type of input unit	U7001 2.5 MS/s INPUT UNIT, U7005 15 MS/s INPUT UNIT
Measurement lines	1-phase/2-wire, 1-phase/3-wire, 3-phase/3-wire, 3-phase/4-wire
Measurement frequency band	U7001: DC, 0.1 Hz to 1 MHz U7005: DC, 0.1 Hz to 5 MHz
Sampling	U7001: 2.5 MHz, 16-bit, U7005: 15 MHz, 18-bit
Data update rate	10 ms, 50 ms, 200 ms
Accuracy for power	± (% of reading + % of range) U7001: (50 Hz/60 Hz) 0.02% + 0.05%, (DC) 0.02% + 0.05%, (50 kHz) 0.4% + 0.1% U7005: (50 Hz/60 Hz) 0.01% + 0.02%, (DC) 0.02% + 0.03%, (50 kHz) 0.15% + 0.05%
Measurement range	Voltage: 6 V/15 V/30 V/60 V/150 V/300 V/600 V/1500 V Current: (Probe1) 100 mA to 2 kA, (Probe2) 100 mA to 50 kA (Range configuration changes depending on the current sensor used, U7001 only for Probe2.)
Measurement parameters	Voltage (U), Current (I), Active power (P), Apparent power (S), Reactive power (Q), Power factor (λ), Phase angle (φ), Voltage frequency (fU), Current frequency (fI), Efficiency (η), Loss (Loss), Voltage ripple factor (Urf), Current ripple factor (Irf), Current integration (Ih), Power integration (WP), Voltage peak (Upk), Current peak (Ipk) Harmonics measurement, Waveform recording, Motor Analysis (Option), FFT analysis*, Flicker measurement*
Calculation function	Efficiency and loss calculations, User-defined calculations*, Delta conversion, Current sensor automatic phase shift calculation
External interface	USB flash drive, LAN, GP-IB, RS-232C, External control, Optical link*, BNC sync*, CAN/CAN FD*
Power supply	100 V to 240 V AC, 50 Hz/60 Hz, 230 VA
Dimensions and mass	Approx. 430 mm (16.93 in) W × 221 mm (8.70 in) H × 361 mm (14.21 in) D Approx. 14kg (493.84 oz)
Included accessories	Power cord ×1, Instruction manual ×1, GENNECT One (PC Applications) CD ×1, D-sub 25-pin connector ×1 (PW8001-02, -05, -12, -15 Only)

- World-class measurement accuracy
  - Basic accuracy ±0.03%, DC accuracy ±0.05%, 50 kHz accuracy 0.2%\*
- Accurate capture of power fluctuations caused by high-speed switching
  - Sampling performance 18-bit\*\*, 15 MHz, Noise Resistance (CMRR) 110 dB, 100 kHz\*\*
- Up to 8 power channels optimizing your measurement
- Current sensor automatic phase correction function\*
- Simultaneous analysis of 4 motors (option)
- Integration of measurement data into CAN networks (option)
- Safe evaluation of increasingly high-voltage solar inverters
  - 1500 V DC CAT II / 1000 V DC CAT III\*\*

\*1: When using the 15MS/S Input Unit U7005 \*2: When used with a current sensor with automatic phase correction functionality \*3: When using the 2.5MS/S Input Unit U7001

Model No. (Order Code)	PW8001-01
	PW8001-02 (D/A output)
	PW8001-03* (CAN/CAN FD)
	PW8001-04* (Optical link)
	PW8001-05* (D/A output, optical link)
	PW8001-06* (CAN/CAN FD, optical link)
	PW8001-11 (Motor analysis)
	PW8001-12 (Motor analysis, D/A output)
	PW8001-13* (Motor analysis, CAN/CAN FD)
	PW8001-14* (Motor analysis, optical link)
	PW8001-15* (Motor analysis, D/A output, optical link)
	PW8001-16* (Motor analysis, CAN/CAN FD, optical link)

\* To be released at the same time as the Ver.2.00 upgrade

- Input units must be specified at the time of ordering  
- Optional input units, voltage cords, and current sensors are required for measurement.

\*To be supported in ver. 2.00

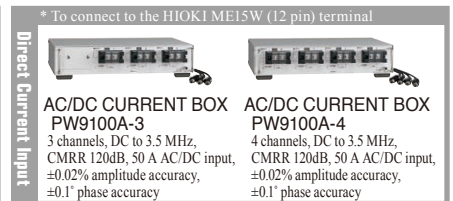
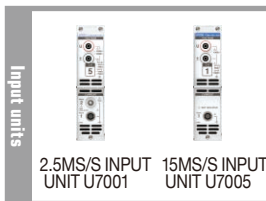

High-Precision Sensors

**Up to 50 A (High precision)**

**AC/DC CURRENT SENSOR CT6872**  
High accuracy pass-through, DC to 10 MHz, 50 A input, ±0.03% amplitude accuracy, ±0.05° phase accuracy, ME15W terminal

**AC/DC CURRENT SENSOR CT6862-05**  
High-precision pull-through type, DC to 1 MHz, 50 A input, ±0.05% amplitude accuracy, ±0.2° phase accuracy, ME15W terminal

**AC/DC CURRENT PROBE CT6841A**  
DC to 1 MHz, 20 A input, ±0.2% amplitude accuracy, ±0.1° phase accuracy, ME15W terminal

**Up to 200 A (High precision)**

**AC/DC CURRENT SENSOR CT6873**  
High accuracy pass-through, DC to 10 MHz, 200 A input, ±0.03% amplitude accuracy, ±0.05° phase accuracy, ME15W terminal

**AC/DC CURRENT SENSOR CT6863-05**  
High-precision pull-through type, DC to 500 kHz, 200 A input, ±0.05% amplitude accuracy, ±0.2° phase accuracy, ME15W terminal

**AC/DC CURRENT PROBE CT6843A**  
DC to 500 kHz, 200 A input, ±0.2% amplitude accuracy, ±0.1° phase accuracy, ME15W terminal

**CLAMP ON SENSOR 9272-05**  
1 Hz to 100 kHz, 20/200 A switching input, ±0.3% amplitude accuracy, ±0.2° phase accuracy, ME15W terminal

**Up to 500 A (High precision)**

**AC/DC CURRENT SENSOR CT6904A**  
High-precision pull-through type, DC to 4 MHz, 500 A input, ±0.02% amplitude accuracy, ±0.08° phase accuracy, ME15W terminal

**AC/DC CURRENT SENSOR CT6875A**  
High-precision pull-through type, DC to 2 MHz, 500 A input, ±0.04% amplitude accuracy, ±0.08° phase accuracy, ME15W terminal

**AC/DC CURRENT PROBE CT6844A**  
DC to 200 kHz, 500 A input, ±0.2% amplitude accuracy, ±0.1° phase accuracy, ME15W terminal

**AC/DC CURRENT PROBE CT6845A**  
DC to 100 kHz, 500 A input, ±0.2% amplitude accuracy, ±0.1° phase accuracy, ME15W terminal

**Up to 1000 A (High precision)**

**AC/DC CURRENT SENSOR CT6876A**  
High-precision pull-through type, DC to 1.5 MHz, 1000 A input, ±0.04% amplitude accuracy, ±0.08° phase accuracy, ME15W terminal

**AC/DC CURRENT PROBE CT6846A**  
DC to 20 kHz, 1000 A input, ±0.2% amplitude accuracy, ±0.1° phase accuracy, ME15W terminal

**Up to 2000 A (High precision)**

**AC/DC CURRENT SENSOR CT6877A**  
High-precision pull-through type, DC to 1 MHz band width, 2000 A input, ±0.04% amplitude accuracy, ±0.08° phase accuracy, ME15W terminal

**Up to 8000 A (High precision)**  
Aggregate and measure large currents in multi-cable circuits

Use multiple AC/DC Current Sensor CT6877A units with the Sensor Unit CT9557 to measure currents up to 8000 A in multi-cable circuits. Requires 1 connection cable to connect the PW8001/PW6001/PW3390 to the CT9557.

**SENSOR UNIT CT9557**  
Power supply for current sensors (4ch, with Waveform/Total Waveform/Total RMS output)

**CONNECTION CABLE CT9904**  
ME15W (12 pin) terminal to ME15W (12 pin) terminal, 1 m (3.28 ft) length (for connecting CT9557 total output to PW8001 only)

**AC/DC CURRENT SENSOR CT6877A**  
High-precision pull-through type, DC to 1 MHz band width, 2000 A input, ±0.04% amplitude accuracy, ±0.08° phase accuracy, ME15W terminal (±0.1% amplitude accuracy, ±0.18° phase accuracy in case of the addition wave output)

**CONVERSION CABLE CT9900**  
Convert PL23 (10-pin) terminal to ME15W (12-pin) terminal  
\*When using a PL.23 terminal sensor, Conversion Cable CT9900 must be used to connect to ME15W terminal.

**High-Precision, high-voltage measurement**

**AC/DC HIGH VOLTAGE DIVIDER VT1005**  
Divides high voltage by 1000:1 and outputs Measurement band: DC to 4 MHz (-3 dB)  
Measurement accuracy: ±0.08% (DC), ±0.04% (50/60 Hz), ±0.17% (50 kHz)

Voltage Input

<b>VOLTAGE CORD L1025</b> 1500 V DC CAT II, 1 A, 1000 V CAT III, 1 A, banana - banana (red, black each), alligator clip, 3 m (9.84 ft) length	<b>VOLTAGE CORD L9438-50</b> Black/ Red, 3 m (9.84 ft) length, Alligator clip ×2	<b>VOLTAGE CORD L1000</b> 1000 V specifications, Red/ Yellow/ Blue/ Gray each 1, Black 4, Alligator clip ×8, 3m (9.84ft) length	<b>CONNECTION CORD L9257</b> 1000 V CAT III, 10 A, 600 V CAT IV, 10 A, banana - banana (red, black each), alligator clip, 1.2 m (3.94 ft) length	<b>PATCH CORD L1021-01</b> Banana branch-banana, Red: 1, Cable length: 0.5 m, For branching from the L9438s or L1000s, CAT IV 600 V, CAT III 1000 V	<b>PATCH CORD L1021-02</b> Banana branch-banana, Black: 1, Cable length: 0.5 m, For branching from the L9438s or L1000s, CAT IV 600 V, CAT III 1000 V	<b>GRABBER CLIP L9243</b> Attaches to the tip of the banana plug cable, Red/ Black: 1 each, 185 mm (7.28 in) length, CAT II 1000 V	<b>CONNECTION CABLE SET L4940</b> 1000 V CAT III, 10 A, 600 V CAT IV, 10 A, banana - banana (red, black each), 1.5 m (4.92 ft) length	<b>ALLIGATOR CLIP SET L4935</b> 1000 V CAT III, 10 A, 600 V CAT IV, 10 A, (red, black each) 1
--	---	--	---	--	--	---	--	--

Connection Options

<b>OPTICAL CONNECTION CABLE L6000</b> 50/125 µm wavelength multimode fiber, 10 m (32.81 ft) length	<b>LAN CABLE 9642</b> Straight Ethernet cable, supplied with straight to cross conversion adapter, 5 m (16.41 ft) length	<b>RS-232C CABLE 9637</b> For the PC, 9pin - 9pin, cross, 1.8m (5.91 ft) length	<b>CONNECTION CABLE 9444</b> For external control interface, 9pin - 9pin, 1.5 m (4.92 ft) length	<b>GP-IB CONNECTOR CABLE 9151-02</b> 2 m (6.56 ft) length	<b>CONNECTION CORD L9217</b> Cord has insulated BNC connectors at both ends, 1.6 m (5.25 ft) length	<b>CONNECTION CORD 9165</b> Cord has metallic BNC connectors at both ends, use at metallic terminal, 1.5 m (4.92 ft) length	<b>CAN CABLE 9713-01</b> For the MR8904, unprocessed on one end, 1.8 m (5.91 ft) length
---	---	--	---	--	--	--	--

**Other options**

The following made-to-order items are also available. Please contact your Hioki distributor or subsidiary for more information

- CARRYING CASE C8001 (hard trunk, with casters)
- D/A OUTPUT CABLE L3000 D-sub 25-pin/BNC (male) 20-channel conversion cable
- BNC TERMINAL BOX Z5200 D-sub 25-pin/BNC (female) 20-channel conversion box
- RACKMOUNT FITTINGSZ5300 (For EIA standard rack)
- RACKMOUNT FITTINGSZ5301 (For JIS standard rack)

Power Analyzers

## Improve Power Conversion Efficiency

### POWER ANALYZER PW6001



- Exclusive current sensor phase shift function lets you maintain accuracy even in high frequency, low power factor applications
- Basic accuracy of  $\pm 0.02\%$ \* for power measurement  
\*1 PW6001 accuracy only. Instrument delivers accuracy of  $\pm 0.07\%$  even after the current sensor accuracy has been added.
- High noise resistance and stability (80 dB/100 kHz CMRR,  $\pm 0.01\%$ /°C temperature characteristics)
- Accurate measurement even when the load is characterized by large fluctuations; TrueHD 18-bit resolution
- 10 ms data refresh while maintaining maximum accuracy (using a specially designed IC to make all measurements independently while performing simultaneous calculations.)
- DC accuracy of  $\pm 0.07\%$ , which is key for stable, accurate efficiency measurement
- Wide frequency bandwidth of DC, or 0.1 Hz to 2 MHz
- Achieve true frequency analysis with high-speed 5MS/s sampling (18 bit)
- Synchronize 2 units for up to 12 channels\* in real time  
\*2 Two 6-channel models can be connected with an optical connection cable
- Special triggers to enable waveform analysis and motor analysis without the need for an oscilloscope
- Wideband harmonic analysis up to the 100th order with a 1.5 MHz band
- Send measured values to HIOKI data loggers using a Bluetooth® wireless technology compatible adapter (LR8410 Link-compatible products)

Model No. (Order Code)	PW6001-01 (1ch)	PW6001-11 (1ch, motor analysis, D/A output)
	PW6001-02 (2ch)	PW6001-12 (2ch, motor analysis, D/A output)
	PW6001-03 (3ch)	PW6001-13 (3ch, motor analysis, D/A output)
	PW6001-04 (4ch)	PW6001-14 (4ch, motor analysis, D/A output)
	PW6001-05 (5ch)	PW6001-15 (5ch, motor analysis, D/A output)
	PW6001-06 (6ch)	PW6001-16 (6ch, motor analysis, D/A output)

Note: Optional voltage cords and current sensor are required for taking measurements. \*Specify the number of built-in channels and inclusion of Motor analysis & D/A output upon order for factory installation. These options cannot be changed or added at a later date.

**CONVERSION CABLE CT9900**  
Convert PL23 (10-pin) terminal to ME15W (12-pin) terminal  
\*When using a PL23 terminal sensor, Conversion Cable CT9900 must be used to connect to ME15W terminal.

#### ■ Basic specifications (Accuracy guaranteed for 6 months, multiply the 6-month accuracy by 1.5 to obtain the 1-year accuracy.)

Measurement line type	Single-phase 2-wire, single-phase 3-wire, three-phase 3-wire, three-phase 4-wire
Number of input channels	Max. 6 channels; each input unit provides 1 channel for simultaneous voltage and current input (Voltage measurement unit: Photosolated input, resistance voltage divider, Current measurement unit: Isolated input from current sensor)
Measurement items	Voltage (U), current (I), active power (P), apparent power (S), reactive power (Q), power factor ( $\lambda$ ), phase angle ( $\phi$ ), frequency (f), efficiency ( $\eta$ ), loss (Loss), voltage ripple factor (Urf), current ripple factor (Irf), current integration (Ih), power integration (WP), voltage peak (Upk), current peak (Ipk) Harmonic measurement: Harmonic active power, select calculation order from 2nd order to 100th order Waveform recording: Voltage and current waveforms/ Motor pulse: Always 5 MS/s Motor waveforms: Always 50 kS/s, 16 bits Recording capacity: 1 Mword $\times$ (voltage + current) $\times$ number of channels + motor waveforms Motor analysis (PW6001-11 to -16 only): Voltage, Torque, Rotation, Frequency, Slip, or Motor output
Measurement range	Voltage range: 6 to 1500 V, 8 ranges Current range (Probe 1): 400 mA to 1 kA (depends on current sensor) Current range (Probe 2): 100 mA to 50 kA (depends on current sensor) Power range: 2.40000W to 4.50000MW (depends on combination of voltage and current range) Frequency range: 0.1 Hz to 2 MHz
Basic accuracy	Voltage: $\pm 0.02\%$ rdg $\pm 0.02\%$ f.s. Current: $\pm 0.02\%$ rdg $\pm 0.02\%$ f.s. Active power: $\pm 0.02\%$ rdg $\pm 0.03\%$ f.s.
Synchronization frequency range	Power measurement: 0.1 Hz to 2 MHz Harmonic measurement: 45 Hz to 66 Hz (IEC standard mode), 0.1 Hz to 300 kHz (Wideband mode)
Frequency band	DC, 0.1 Hz to 2 MHz
Data update rate	Power measurement: 10 ms/ 50 ms/ 200 ms Harmonic measurement: 200 ms (IEC standard mode), 50 ms (Wideband mode)
Data save interval	OFF, 10 msec to 500 msec, 1 sec to 30 sec, 1 minute to 60 minutes, User-selected from all measured values, including harmonic measured values, Specified measured values can be saved in internal memory or USB flash drive.
External interfaces	USB (memory), LAN, GP-IB, RS-232C (for communication/LR8410 link), External control, Synchronization control
Logger connectivity	Sends measured values wirelessly to logger by using a Bluetooth® wireless technology serial conversion adapter. (Supported devices: Hioki LR8410 Link-compatible loggers), Ver. 2.0 and later
Power supply	100 to 240 V AC, 50/60 Hz, 200 VA max.
Dimensions and mass	430 mm (16.93 in)W $\times$ 177 mm (6.97 in)H $\times$ 450 mm (17.72 in)D, 14 kg (49.4 oz) (PW6001-16)
Included accessories	Instruction Manual $\times$ 1, Power cord $\times$ 1, D-sub connector $\times$ 1 (PW6001-1x only)

**AC/DC CURRENT BOX PW9100A-3**  
3 channels, DC to 3.5 MHz, CMRR 120dB, 50 A AC/DC input,  $\pm 0.02\%$  amplitude accuracy,  $\pm 0.1^\circ$  phase accuracy

**AC/DC CURRENT BOX PW9100A-4**  
4 channels, DC to 3.5 MHz, CMRR 120dB, 50 A AC/DC input,  $\pm 0.02\%$  amplitude accuracy,  $\pm 0.1^\circ$  phase accuracy

\* To connect to the HIOKI ME15W (12 pin) terminal

High-Precision Sensors	<b>Up to 50 A (High precision)</b> <b>AC/DC CURRENT SENSOR CT6872</b> High accuracy pass-through, DC to 10 MHz, 50 A input, $\pm 0.03\%$ amplitude accuracy, $\pm 0.05^\circ$ Phase accuracy, ME15W terminal <b>AC/DC CURRENT SENSOR CT6862-05</b> High-precision pull-through type, DC to 1 MHz, 50 A input, $\pm 0.05\%$ amplitude accuracy, $\pm 0.2^\circ$ phase accuracy, ME15W terminal <b>AC/DC CURRENT PROBE CT6841A</b> DC to 1 MHz, 20 A input, $\pm 0.2\%$ amplitude accuracy, $\pm 0.1^\circ$ phase accuracy, ME15W terminal	<b>Up to 500 A (High precision)</b> <b>AC/DC CURRENT SENSOR CT6904A</b> High-precision pull-through type, DC to 4 MHz, 500 A input, $\pm 0.02\%$ amplitude accuracy, $\pm 0.08^\circ$ phase accuracy, ME15W terminal <b>AC/DC CURRENT SENSOR CT6875A</b> High-precision pull-through type, DC to 2 MHz, 500 A input, $\pm 0.04\%$ amplitude accuracy, $\pm 0.08^\circ$ phase accuracy, ME15W terminal <b>AC/DC CURRENT PROBE CT6844A</b> DC to 200 kHz, 500 A input, $\pm 0.2\%$ amplitude accuracy, $\pm 0.1^\circ$ phase accuracy, ME15W terminal <b>AC/DC CURRENT PROBE CT6845A</b> DC to 100 kHz, 500 A input, $\pm 0.2\%$ amplitude accuracy, $\pm 0.1^\circ$ phase accuracy, ME15W terminal	<b>Up to 8000 A (High precision)</b> Aggregate and measure large currents in multi-cable circuits Use multiple AC/DC Current Sensor CT6877A units with the Sensor Unit CT9557 to measure currents of up to 8000 A in multi-cable circuits. Requires 1 connection cable to connect the PW8001/PW6001/PW3390 to the CT9557. <b>SENSOR UNIT CT9557</b> Power supply for current sensors (4ch, with Waveform/Total Waveform/Total RMS output) <b>CONNECTION CABLE CT9904</b> ME15W (12 pin) terminal to ME15W (12 pin) terminal, 1 m (3.28 ft) length (for connecting CT9557 total output to PW8001 only) <b>AC/DC CURRENT SENSOR CT6877A</b> High-precision pull-through type, DC to 1 MHz band width, 2000 A input, $\pm 0.04\%$ amplitude accuracy, $\pm 0.08^\circ$ phase accuracy, ME15W terminal ( $\pm 0.1\%$ amplitude accuracy, $\pm 0.18^\circ$ phase accuracy in case of the addition wave output)
	<b>Up to 200 A (High precision)</b> <b>AC/DC CURRENT SENSOR CT6873</b> High accuracy pass-through, DC to 10 MHz, 200 A input, $\pm 0.03\%$ amplitude accuracy, $\pm 0.05^\circ$ Phase accuracy, ME15W terminal <b>AC/DC CURRENT SENSOR CT6863-05</b> High-precision pull-through type, DC to 500 kHz, 200 A input, $\pm 0.05\%$ amplitude accuracy, $\pm 0.2^\circ$ phase accuracy, ME15W terminal <b>AC/DC CURRENT PROBE CT6843A</b> DC to 500 kHz, 200 A input, $\pm 0.2\%$ amplitude accuracy, $\pm 0.1^\circ$ phase accuracy, ME15W terminal	<b>Up to 1000 A (High precision)</b> <b>AC/DC CURRENT SENSOR CT6876A</b> High-precision pull-through type, DC to 1.5 MHz, 1000 A input, $\pm 0.04\%$ amplitude accuracy, $\pm 0.08^\circ$ phase accuracy, ME15W terminal <b>AC/DC CURRENT PROBE CT6846A</b> DC to 20 kHz, 1000 A input, $\pm 0.2\%$ amplitude accuracy, $\pm 0.1^\circ$ phase accuracy, ME15W terminal	<b>High-Precision, high-voltage measurement</b> <b>AC/DC HIGH VOLTAGE DIVIDER VT1005</b> Divides high voltage by 1000:1 and outputs Measurement band: DC to 4 MHz (-3 dB) Measurement accuracy: $\pm 0.08\%$ (DC), $\pm 0.04\%$ (50/60 Hz), $\pm 0.17\%$ (50 kHz)
	<b>Up to 2000 A (High precision)</b> <b>AC/DC CURRENT SENSOR CT6877A</b> High-precision pull-through type, DC to 1 MHz band width, 2000 A input, $\pm 0.04\%$ amplitude accuracy, $\pm 0.08^\circ$ phase accuracy, ME15W terminal		

Wide-Band Current Probes	<b>Up to 5 A (High speed)</b> <b>CURRENT PROBE CT6700</b> Wide DC to 50 MHz bandwidth, 1 mA to 5 A rms <b>CURRENT PROBE CT6701</b> Wide DC to 120 MHz bandwidth, 1 mA to 5 A rms	<b>Up to 30 A (High speed)</b> <b>CLAMP ON PROBE 3273-50</b> Wide DC to 50 MHz bandwidth, 10 mA-class to 30 Arms <b>CLAMP ON PROBE 3276</b> Wide DC to 100 MHz bandwidth, 10 mA-class to 30 Arms	<b>Up to 500 A (High speed)</b> <b>CLAMP ON PROBE 3274</b> Wide DC to 10 MHz bandwidth, up to 150 A rms <b>CLAMP ON PROBE 3275</b> Wide DC to 2 MHz bandwidth, up to 500 A rms	* To connect to the Probe2 input terminal
--------------------------	--	--	--	---

Voltage Input	<b>VOLTAGE CORD L9438-50</b> 1000 V specifications, Red/Black/Red, 3 m (9.84 ft) length, Alligator clip $\times$ 2	<b>VOLTAGE CORD L1000</b> 1000 V specifications, Red/Yellow/Blue/Gray each 1, Black 4, Alligator clip $\times$ 8, 3m (9.84ft) length	<b>GRABBER CLIP L9243</b> Attaches to the tip of the banana plug cable, Red/Black: 1 each, 185 mm (7.28 in) length, CAT II 1000 V	<b>PATCH CORD L1021-01</b> Banana branch-banana, Red: 1, Cable length: 0.5 m, For branching from the L9438s or L1000s, CAT IV 600 V, CAT III 1000 V	<b>PATCH CORD L1021-02</b> Banana branch-banana, Black: 1, Cable length: 0.5 m, For branching from the L9438s or L1000s, CAT IV 600 V, CAT III 1000 V
---------------	---	---	--	--	--

Connection Options	<b>OPTICAL CONNECTION CABLE L6000</b> 50/125 $\mu$ m wavelength multimode fiber, 10 m (32.81 ft) length	<b>LAN CABLE 9642</b> Straight Ethernet cable, supplied with straight to cross conversion adapter, 5 m (16.41 ft) length	<b>RS-232C CABLE 9637</b> For the PC, 9pin - 9pin, cross, 1.8m (5.91 ft) length	<b>CONNECTION CABLE 9444</b> For external control interface, 9 pin - 9 pin, 1.5 m (4.92 ft) length	<b>GP-IB CONNECTOR CABLE 9151-02</b> 2 m (6.56 ft) length	<b>CONNECTION CORD L9217</b> Cord has insulated BNC connectors at both ends, 1.6 m (5.25 ft) length
--------------------	--	---	--	---	--	--

\* L9217: for motor analysis input

**Other options**  
The following made-to-order items are also available. Please contact your Hioki distributor or subsidiary for more information

- Carrying case (hard trunk, with casters)
- D/A output cable, D-sub 25-pin - BNC (male), 20 ch conversion
- Bluetooth® serial converter adapter cable 1 m (3.28 ft)
- Rackmount fittings (EIA, JIS)
- Optical connection cable, Max. 500 m (1640.55 ft) length
- PW9100 5 A rating version



## High-accuracy Power Analysis - Anywhere, Anytime

### POWER ANALYZER PW3390



- ±0.04% basic power accuracy, among the best in its class
- 200 kHz measurement band with flat amplitude and phase accuracy that extend to high frequencies
- Remarkably small and light footprint, enabling high-accuracy measurement to be easily carried out even in the field
- High-accuracy, high-speed calculation of transient-state power in 50 ms; harmonic analysis; display of instantaneous waveforms; noise analysis; and simultaneous parallel calculation of all parameters, including efficiency loss
- Send measured values to HIOKI data loggers using a Bluetooth® wireless technology compatible adapter (LR8410 Link-compatible products)
- Simultaneous measurement of multiple circuits and ability to acquire synchronized data using up to 8 devices (for 32 channels)
- Simple power measurement using clamp-on current sensors
- Measurement of current and power inputs and outputs as part of the new international WLTP fuel efficiency standard

Model No. (Order Code) **PW3390-01**  
**PW3390-02** (D/A output)  
**PW3390-03** (D/A output, motor analysis)

Note: PW3390 by itself does not support current and power measurements. Optional current sensor and voltage cord are necessary to measure current or power parameters. Specify inclusion of Motor analysis & D/A output upon order for factory installation. These options cannot be changed or added after delivery.

#### Basic specifications (Accuracy guaranteed for 6 months, multiply the 6-month accuracy by 1.25 to obtain the 1-year accuracy.)

Measurement line type	Single-phase 2-wire, single-phase 3-wire, three-phase 3-wire, three-phase 4-wire, Voltage 4 channels, Current 4 channels, Isolated between each channel
Basic measurement parameters	Frequency, RMS voltage, voltage mean value rectification RMS equivalent, voltage AC component, voltage simple average, voltage fundamental wave component, voltage waveform peak +, voltage waveform peak -, voltage total harmonic distortion, voltage ripple factor, voltage unbalance factor, RMS current, current mean value rectification RMS equivalent, current AC component, current simple average, current fundamental wave component, current waveform peak +, current waveform peak -, current total harmonic distortion, current ripple factor, current unbalance factor, active power, apparent power, reactive power, power factor, voltage phase angle current phase angle, power phase angle, positive-direction current magnitude, negative-direction current magnitude, sum of positive- and negative-direction current magnitude, positive-direction power magnitude, negative-direction power magnitude, sum of positive- and negative-direction power magnitude, efficiency, loss Current integration, active power integration PW3390-03 only: Torque, Rotation, Frequency, Slip, or Motor power
Harmonic measurement	Input: 4 ch, Synchronization frequency range: 0.5 Hz to 5 kHz, Number of harmonic orders: Max. 100th order
Noise measurement	Number of channels: 1 ch (select one channel from CH1 to CH4), Maximum analysis frequency: 200 k/ 50 k/ 20 k/ 10 k/ 5 k/ 2 kHz
Motor Analysis (PW3390-03 only)	Input: 3 ch (CH A, CH B, CH Z), Measurement parameters: Voltage, torque, rotation rate, frequency, slip, and motor power
Measurement range	Voltage range: 15 to 1500 V, 7 ranges Current range: 0.1 A to 20 kA (depends on current sensor)
Effective measuring power range	0.0150 W to 39.600 MW (determined automatically by the combination of voltage range, current range, and measurement line)
Basic accuracy (45 to 66 Hz)	Voltage: ±0.04 % rdg ±0.05 % f.s. Current: ±0.04 % rdg ±0.05 % f.s. Active power: ±0.04 % rdg ±0.05 % f.s.
Synchronization frequency range	0.5 Hz to 5 kHz
Frequency band	DC, 0.5 Hz to 200 kHz
Data update rate	50 ms (For harmonic/frequency measurement, depends on the synchronization frequency when less than 45 Hz)
Display refresh rate	200 ms (Independent of internal data update rate; waveform and FFT depend on the screen)
Auto-Save Functions	Each value is stored to CF card during every measurement interval (not available for USB storage), OFF, 50 msec to 500 msec, 1 sec to 30 sec, 1 minute to 60 minutes, 15 settings
External interfaces	LAN, USB (for communication/ memory), RS-232C (for communication/LR8410 link), CF card, Synchronization control, External Control
Logger connectivity	Sends measured values wirelessly to logger by using a Bluetooth® wireless technology serial conversion adapter. (Supported devices: Hioki LR8410 Link-compatible loggers)
Power supply	100 to 240 V AC, 50/60 Hz, 140 VA max.
Dimensions and mass	340 mm (13.39 in)W × 170 mm (6.69 in)H × 156 mm (6.14 in)D, 4.6 kg (162.3 oz)
Included accessories	Instruction Manual ×1, Power cord ×1, Measurement Guide ×1, USB cable ×1, Input cord label ×2, D-sub connector × 1 (PW3390-02, PW3390-03)

## Accurately Measure High Voltages up to 5000 V, Ideal for Measuring the Efficiency of High-voltage Inverters

### AC/DC HIGH VOLTAGE DIVIDER VT1005



- Divides high voltage by 1000:1 and outputs Max. Input 5000 V (\*1), 2000 V CAT II, 1500 V CAT III
- Measure the efficiency of high-efficiency inverters with a high degree of precision  
 Measurement accuracy: ±0.08% (DC), ±0.04% (50/60 Hz), ±0.17% (50 kHz)  
 Frequency flatness: ±0.1% amplitude band 200 kHz typical, ±0.1° phase band 500 kHz typical (\*2)  
 Measurement band: DC to 4 MHz (-3 dB)  
 Noise resistance: CMRR 80 dB typical (100 kHz), differential input method

\*1: ±7100 V peak, no measurement category, anticipated transient overvoltage of 0 V  
 \*2: After phase correction by the power analyzer

Model No. (Order Code) **VT1005**

#### Basic specifications (Accuracy guaranteed for 1 year)

Maximum rated voltage	5000 V rms, ±7100 V peak (within the frequency derating range)
Maximum rated voltage (line-to-ground)	No measurement category: 5000 V AC/DC (*5) Measurement category II: 2000 V AC/DC (*4) Measurement category III: 1500 V AC/DC (*5)
Measurement accuracy	±0.08% (DC), ±0.04% (50/60 Hz), ±0.17% (50 kHz)
Frequency flatness	Band where amplitude falls within ±0.1% range: 200 kHz (typical) Band where phase falls within ±0.1° range: 500 kHz (typical) (*2)
Measurement bandwidth	DC to 4 MHz (amplitude and phase accuracy specified up to 1 MHz)
Voltage dividing ratio	1000 : 1
Common-mode voltage rejection ratio (CMRR)	50 Hz/60 Hz: 90 dB (typical) 100 kHz: 80 dB (typical)
Measurement method	Differential input
Operating temperature and humidity range	-10°C to 50°C (14°F to 122°F), 80% RH or less (non-condensing)
Power supply	100 V to 240 V AC (50/60 Hz)
Dimensions and mass	Approx. 195.0 mm (7.68 in) W × 83.2 mm (3.28 in) H × 346.0 mm (13.62 in) D mm, approx. 2.2 kg (77.6 oz.)
Included accessory	L1050-01 Voltage Cord (1.6 m/ 5.25 ft) × 1, L9217 Connection Cord (insulated BNC, 1.6 m/ 5.25 ft) × 1, 9704 Conversion Adapter (insulated-female BNC-to-banana plug) × 1, Power cord × 1

\*2: After phase correction by the power analyzer

\*3: ±7100 V peak, anticipated transient overvoltage 0 V

\*4: Anticipated transient overvoltage 12000 V

\*5: Anticipated transient overvoltage 10000 V

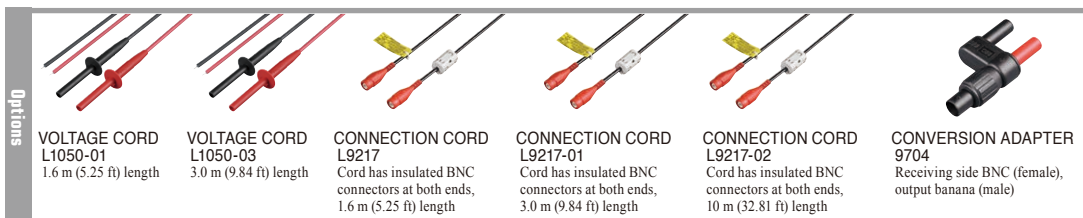

# Power Analyzers

## Options for PW3390

For other options, please see the product catalog.

High-Precision Sensors	<p><b>Up to 50 A (High precision)</b></p> <p><b>AC/DC CURRENT SENSOR CT6872</b> High accuracy pass-through, DC to 10 MHz, 50 A input, <math>\pm 0.03\%</math> amplitude accuracy, <math>\pm 0.05^\circ</math> phase accuracy, ME15W terminal</p> <p><b>AC/DC CURRENT SENSOR CT6862-05</b> High-precision pull-through type, DC to 1 MHz, 50 A input, <math>\pm 0.05\%</math> amplitude accuracy, <math>\pm 0.2^\circ</math> phase accuracy, ME15W terminal</p> <p><b>AC/DC CURRENT PROBE CT6841A</b> DC to 1 MHz, 20 A input, <math>\pm 0.2\%</math> amplitude accuracy, <math>\pm 0.1^\circ</math> phase accuracy, ME15W terminal</p>	<p><b>Up to 500 A (High precision)</b></p> <p><b>AC/DC CURRENT SENSOR CT6904A</b> High-precision pull-through type, DC to 4 MHz, 500 A input, <math>\pm 0.02\%</math> amplitude accuracy, <math>\pm 0.08^\circ</math> phase accuracy, ME15W terminal</p> <p><b>AC/DC CURRENT SENSOR CT6875A</b> High-precision pull-through type, DC to 2 MHz, 500 A input, <math>\pm 0.04\%</math> amplitude accuracy, <math>\pm 0.08^\circ</math> phase accuracy, ME15W terminal</p> <p><b>AC/DC CURRENT PROBE CT6844A</b> DC to 200 kHz, 500 A input, <math>\pm 0.2\%</math> amplitude accuracy, <math>\pm 0.1^\circ</math> phase accuracy, ME15W terminal</p> <p><b>AC/DC CURRENT PROBE CT6845A</b> DC to 100 kHz, 500 A input, <math>\pm 0.2\%</math> amplitude accuracy, <math>\pm 0.1^\circ</math> phase accuracy, ME15W terminal</p>	<p><b>Up to 8000 A (High precision)</b> Aggregate and measure large currents in multi-cable circuits</p> <p>Use multiple AC/DC Current Sensor CT6877A units with the Sensor Unit CT9557 to measure currents of up to 8000 A in multi-cable circuits. Requires 1 connection cable to connect the PW8001/PW6001/PW3390 to the CT9557.</p> <p><b>SENSOR UNIT CT9557</b> Power supply for current sensors (4ch, with Waveform/Total Waveform/Total RMS output)</p> <p><b>CONNECTION CABLE CT9904</b> ME15W (12 pin) terminal to ME15W (12 pin) terminal, 1 m (3.28 ft) length (for connecting CT9557 total output to PW8001 only)</p> <p><b>AC/DC CURRENT SENSOR CT6877A</b> High-precision pull-through type, DC to 1 MHz band width, 2000 A input, <math>\pm 0.04\%</math> amplitude accuracy, <math>\pm 0.08^\circ</math> phase accuracy, ME15W terminal (<math>\pm 0.1\%</math> amplitude accuracy, <math>\pm 0.18^\circ</math> phase accuracy in case of the addition wave output)</p>
	<p><b>Up to 200 A (High precision)</b></p> <p><b>AC/DC CURRENT SENSOR CT6873</b> High accuracy pass-through, DC to 10 MHz, 200 A input, <math>\pm 0.03\%</math> amplitude accuracy, <math>\pm 0.05^\circ</math> phase accuracy, ME15W terminal</p> <p><b>AC/DC CURRENT SENSOR CT6863-05</b> High-precision pull-through type, DC to 500 kHz, 200 A input, <math>\pm 0.05\%</math> amplitude accuracy, <math>\pm 0.2^\circ</math> phase accuracy, ME15W terminal</p> <p><b>AC/DC CURRENT PROBE CT6843A</b> DC to 500 kHz, 200 A input, <math>\pm 0.2\%</math> amplitude accuracy, <math>\pm 0.1^\circ</math> phase accuracy, ME15W terminal</p> <p><b>CLAMP ON SENSOR 9272-05</b> 1 Hz to 100 kHz, 20/200 A switching input, <math>\pm 0.3\%</math> amplitude accuracy, <math>\pm 0.2^\circ</math> phase accuracy, ME15W terminal</p>	<p><b>Up to 1000 A (High precision)</b></p> <p><b>AC/DC CURRENT SENSOR CT6876A</b> High-precision pull-through type, DC to 1.5 MHz, 1000 A input, <math>\pm 0.04\%</math> amplitude accuracy, <math>\pm 0.08^\circ</math> phase accuracy, ME15W terminal</p> <p><b>AC/DC CURRENT PROBE CT6846A</b> DC to 20 kHz, 1000 A input, <math>\pm 0.2\%</math> amplitude accuracy, <math>\pm 0.1^\circ</math> phase accuracy, ME15W terminal</p>	<p><b>PL23 (10 pin) - ME15W (12 pin) conversion</b></p> <p><b>CONVERSION CABLE CT9900</b> Convert PL23 (10-pin) terminal to ME15W (12-pin) terminal</p> <p>*When using a PL23 terminal sensor, Conversion Cable CT9900 must be used to connect to ME15W terminal.</p>
	<p><b>Up to 2000 A (High precision)</b></p> <p><b>AC/DC CURRENT SENSOR CT6877A</b> High-precision pull-through type, DC to 1 MHz band width, 2000 A input, <math>\pm 0.04\%</math> amplitude accuracy, <math>\pm 0.08^\circ</math> phase accuracy, ME15W terminal</p>		

\* To connect to the HIOKI ME15W (12 pin) terminal

**AC/DC CURRENT BOX PW9100A-3**  
3 channels, DC to 3.5 MHz, CMRR 120dB, 50 A AC/DC input,  $\pm 0.02\%$  amplitude accuracy,  $\pm 0.1^\circ$  phase accuracy

**AC/DC CURRENT BOX PW9100A-4**  
4 channels, DC to 3.5 MHz, CMRR 120dB, 50 A AC/DC input,  $\pm 0.02\%$  amplitude accuracy,  $\pm 0.1^\circ$  phase accuracy

**AC/DC HIGH VOLTAGE DIVIDER VT1005**

Divides high voltage by 1000:1 and outputs Measurement band: DC to 4 MHz (-3 dB) Measurement accuracy:  $\pm 0.08\%$  (DC),  $\pm 0.04\%$  (50/60 Hz),  $\pm 0.17\%$  (50 kHz)

\* The CT9920 is necessary for connecting a current sensor with a HIOKI PL14 connector to the PW3390

**AC/DC CURRENT SENSOR CT7642**  
DC to 10kHz, 2000A AC/DC,  $\phi$  55 mm (2.17 in), 2.5 m (8.20 ft) cord length, Output connector: PL14 terminal

**AC/DC AUTO ZERO CURRENT SENSOR CT7742**  
DC to 5 kHz, 2000A AC/DC,  $\phi$  55 mm (2.17 in), 2.5 m (8.20 ft) cord length, Output connector: PL14 terminal

**CONVERSION CABLE CT9920**  
Required to connect the PW3390 or other instrument's ME15W terminal to a current sensor with a PL14 output connector.

\* The CT9920 is necessary for connecting a current sensor with a HIOKI PL14 connector to the PW3390

**AC FLEXIBLE CURRENT SENSOR CT7044**  
6000 A AC,  $\phi$ 100 mm (3.94 in), 2.5 m (8.20 ft) cord length, PL14 terminal

**AC FLEXIBLE CURRENT SENSOR CT7045**  
6000 A AC,  $\phi$ 180 mm (7.09 in), 2.5 m (8.20 ft) cord length, PL14 terminal

**AC FLEXIBLE CURRENT SENSOR CT7046**  
6000 A AC,  $\phi$ 254 mm (10.00 in), 2.5 m (8.20 ft) cord length, PL14 terminal

**CONVERSION CABLE CT9920**  
Required to connect the PW3390 or other instrument's ME15W terminal to a current sensor with a PL14 output connector.

**VOLTAGE CORD L9438-50**  
Black/ Red, 3 m (9.84 ft) length, Alligator clip  $\times 2$

**VOLTAGE CORD L1000**  
1000 V specifications, Red/ Yellow/ Blue/ Gray each 1, Black 4, Alligator clip  $\times 8$ , 3m (9.84ft) length

**EXTENSION CABLE SET L4931**  
Expands the length of the cable with banana plug, 1.5 m (4.92 ft) length

**WIRING ADAPTER PW9000**  
When three-phase 3-wire (3P3W3M) connection, this product allows you to reduce the number of voltage cords from 6 to 3.

**WIRING ADAPTER PW9001**  
When three-phase 4-wire (3P4W) connection, this product allows you to reduce the number of voltage cords from 6 to 4.

**PATCH CORD L1021-01**  
Banana branch-banana, Red, 1, Cable length: 0.5 m, For branching from the L9438s or L1000s, CAT IV 600 V, CAT III 1000 V

**PATCH CORD L1021-02**  
Banana branch-banana, Black, 1, Cable length: 0.5 m, For branching from the L9438s or L1000s, CAT IV 600 V, CAT III 1000 V

**GRABBER CLIP L9243**  
Attaches to the tip of the banana plug cable, Red/ Black: 1 each, 185 mm (7.28 in) length, CAT III 1000 V

\* L9217: for motor analysis input

**CONNECTION CORD L9217**  
Cord has insulated BNC connectors at both ends, 1.6 m (5.25 ft) length

**LAN CABLE 9642**  
Straight Ethernet cable, supplied with straight to cross conversion adapter, 5 m (16.41 ft) length

**CONNECTION CABLE 9683**  
For synchronization, cable length 1.5 m (4.92 ft)

**RS-232C CABLE 9637**  
For the PC, 9pin - 9pin, cross, 1.8m (5.91 ft) length

**PC Card Precaution**  
Use only PC Cards sold by HIOKI. Compatibility and performance are not guaranteed for PC cards made by other manufacturers. You may be unable to read from or save data to such cards.

**PC CARD 2G 9830**  
**PC CARD 1G 9729**  
**PC CARD 512M 9728**

**CARRYING CASE 9794**  
Hard trunk to protect your PW3390 during transportation, with casters.

**Other options**

- D/A output cable
- D-sub 25-pin - BNC (male)
- Rackmount fittings (For EIA or JIS)
- PW9100 5A-rated model

## New Wideband High-Accuracy Current Measurement Option

### AC/DC CURRENT BOX PW9100A



- Combined accuracy with HIOKI power analyzer PW8001, PW6001 and PW3390 is specified (DC, 45 Hz  $\leq$  f  $\leq$  65 Hz). For details of combined accuracy, refer to the instruction manual.
- World-leading measurement bands and accuracy
- Wide-band DC to 3.5MHz, 50A AC/DC rated input
- $\pm 0.05\%$  power accuracy in combination with PW8001 (using U7005, 45 Hz  $<$  f  $\leq$  65 Hz)
- 120dB CMRR (100 kHz)
- Full-rack size suitable for test/evaluation benches
- Current measurement option for POWER ANALYZERS

<b>Basic specifications</b> (Accuracy guaranteed for 1 year)	
Measurement line type	Isolated input, DCCT input
Rated primary current	50 A AC/DC
Number of input channels	PW9100-03: 3 channels, PW9100-04: 4 channels
Maximum input current	60 A, within derating. However, up to $\pm 200$ A peak is allowable if within 20 ms (design value)
Amplitude and Phase accuracy	DC ( $\pm 0.02\%$ rdg $\pm 0.007\%$ f.s.) 45 Hz $<$ f $\leq$ 65 Hz ( $\pm 0.02\%$ rdg $\pm 0.005\%$ f.s., Phase: $\pm 0.1$ deg.) Accuracy is defined to 1 MHz
Output voltage	2 V/50 A
Measurement terminals	Terminal block (with safety cover), M6 screws
Input resistance	1.5 m $\Omega$ or less (50 Hz/60 Hz)
Input capacitance	Between measurement terminals and case (secondary side), 40 pF or less, defined at 100 kHz
Operating temperature and humidity	Temperature: 0°C to 40°C (32°F to 104°F), Humidity: 80% RH or less (no condensation)
Power supply	Power supply from PW8001, PW6001, PW3390
Dimensions and mass	430 mm (16.93 in) W $\times$ 88 mm (3.46 in) H $\times$ 260 mm (10.24 in) D, Cable length: 0.8 m (2.62 ft) PW9100A-3: 3.7 kg (130.5 oz), PW9100A-4: 4.3 kg (151.7 oz)
Included accessory	Instruction Manual $\times 1$

Model No. (Order Code) **PW9100A-3** (For the PW8001/PW6001/PW3390, 3 ch)  
**PW9100A-4** (For the PW8001/PW6001/PW3390, 4 ch)

**Option**

**CONVERSION CABLE CT9901**  
ME15W (12 pin) to PL23 (10 pin) connector

**EXTENSION CABLE CT9902**  
5 m (16.41 ft) length, ME15W (12 pin) - ME15W (12 pin) connector

Only 1 unit of CT9902 can be used at any one time.

**Rack mount hardware**  
Made-to-order, for EIA/JIS  
Contact your local Hioki distributor for more information

## Accurately Measure Devices Up to 1000 V/65 A AC/DC with Direct Input

### POWER METER PW3337



- Compatible with the SPECpower® benchmark for server power consumption. SPECpower® is a registered trademark of Standard Performance Evaluation Corporation.
- Measure DC, and single-phase 2-wire to 3-phase 4-wire with 3-channel input.
- For development and production of motors, inverters, power conditioners, power supplies, and other devices.
- High-precision basic accuracy of  $\pm 0.1\%$  (\*1)
- (\*1) For complete details, please refer to the specifications
- Wide frequency bandwidth of 0.1 Hz to 100 kHz or DC
- High-current measurement up to 65 A of direct input
- Harmonic measurement up to the 50th order according to IEC 61000-4-7
- High-accuracy measurement, even with a low power factor for no-load testing of transformers and motors
- Built-in external sensor input terminals to measure up to 5000 A AC
- Synchronize up to 8 units for multi-unit measurement
- Create a 6-channel power meter by synchronizing two PW3337 units and using the free PC application

Model No. (Order Code)	<b>PW3337</b>	(3ch)
	<b>PW3337-01</b>	(3ch, built-in GP-IB)
	<b>PW3337-02</b>	(3ch, built-in D/A output)
	<b>PW3337-03</b>	(3ch, built-in GP-IB, D/A output)

#### ■ Basic specifications (Accuracy guaranteed for 1 year)

Measurement lines	Single-phase 2-wires, single-phase 3-wires, 3-phase 3-wires, 3-phase 4-wires (voltage / current measurement range set for each wiring mode)
Measurement items	Voltage, Current, Active power, Apparent power, Reactive power, Power factor, Phase angle, Frequency, Efficiency, Current integration, Active power integration, Integrated time, Voltage waveform peak value, Current waveform peak value, Voltage crest factor, Current crest factor, Time average current, Time average active power, Voltage ripple factor, Current ripple factor
Harmonic parameters	Synchronization frequency range: 10 Hz to 640 Hz, Analysis order up to 50th Harmonic voltage RMS value, Harmonic current RMS value, Harmonic active power, Total harmonic voltage distortion, Total harmonic current distortion, Voltage fundamental waveform, Current fundamental waveform, Active power fundamental waveform, Apparent power fundamental waveform, Reactive power fundamental waveform, Power factor fundamental waveform (displacement power factor), Voltage current phase difference fundamental waveform, Interchannel voltage fundamental wave phase difference, Interchannel current fundamental wave phase difference, Harmonic voltage content %, Harmonic current content %, Harmonic active power content % (The following parameters can be downloaded as data during PC communication but not displayed: Harmonic voltage phase angle, Harmonic current phase angle, Harmonic voltage current phase difference)
Measurement range(*2)	[Voltage] 0.15 V to 1000 V AC/DC [Current] Direct input: 2 mA to 65 A AC/DC For AC/DC measurement using the CT6877A as an example: 4 A to 2000 A AC/DC (typical accuracy $\pm 0.348\%$ ) For AC measurement using the CT9667-01 as an example: 10 A to 5000 A AC (typical accuracy $\pm 2.6\%$ )
Integration measurement (Integration time up to 10,000 hours)	[Current] No. of displayed digits: 6 digits (from 0.00000 mA, Polarity-independent integration and Sum value) [Active power] No. of displayed digits: 6 digits (from 0.00000 mWh, Polarity-independent integration and Sum value)
Input resistance (50/60 Hz)	[Voltage] 2 M $\Omega$ , [Current] 1 m $\Omega$ or less (direct input)
Basic accuracy (Active power)	$\pm 0.1\%$ rdg $\pm 0.1\%$ f.s. (DC) $\pm 0.1\%$ rdg $\pm 0.05\%$ f.s. (45 Hz to 66 Hz, at Input < 50% f.s.) $\pm 0.15\%$ rdg (45 Hz to 66 Hz, at 50% f.s. $\leq$ Input)
Display refresh rate	5 times/s to 20 seconds (depends on average times settings)
Frequency characteristics	DC, 0.1 Hz to 100 kHz
D/A output (-02/-03 model only)	16 channels (selectable from following items): Level output DC $\pm 2$ V, Waveform output 1 V f.s. Level output, instantaneous waveform output (voltage, current, active power), Level output (apparent power, reactive power, power factor, or other), High-speed active power level output
Functions	[Rectification method] AC+DC, AC+DC Umn, AC, DC, FND, Auto-range, Average, VT or CT ratio settings, Synchronized control, MAX/MIN, or other functions
Interfaces	RS-232C / LAN standard, (-01/-03 model also includes GP-IB)
Power supply	100 to 240 V AC, 50/60 Hz, 40 VA max.
Dimensions and mass	305 mm (12.01 in)W $\times$ 132 mm (5.20 in)H $\times$ 256 mm (10.08 in)D, 5.6 kg (197.5 oz)
Included accessories	Instruction manual $\times 1$ , Measurement guide $\times 1$ , Power cord $\times 1$

(\*2) MIN./MAX. current values and accuracy will vary depending on the current sensor used.

#### Shared options for the POWER METER PW3337, PW3336, and PW3335 series

## Accurately Measure Devices Up to 1000 V/65 A AC/DC with Direct Input

### POWER METER PW3336



- Compatible with the SPECpower® benchmark for server power consumption. SPECpower® is a registered trademark of Standard Performance Evaluation Corporation.
- Measure DC and single-phase 2-wire to 3-phase 3-wire with 2-channel input.
- For development and production of motors, inverters, power conditioners, power supplies, and other devices.
- High-precision basic accuracy of  $\pm 0.1\%$  (\*1)
- (\*1) For complete details, please refer to the specifications
- Wide frequency bandwidth of 0.1 Hz to 100 kHz or DC
- High-current measurement up to 65 A of direct input
- Harmonic measurement up to the 50th order according to IEC 61000-4-7
- High-accuracy measurement, even with a low power factor for no-load testing of transformers and motors
- Built-in external sensor input terminals to measure up to 5000 A AC
- Synchronize up to 8 units for multi-unit measurement

Model No. (Order Code)	<b>PW3336</b>	(2ch)
	<b>PW3336-01</b>	(2ch, built-in GP-IB)
	<b>PW3336-02</b>	(2ch, built-in D/A output)
	<b>PW3336-03</b>	(2ch, built-in GP-IB, D/A output)

#### ■ Basic specifications (Accuracy guaranteed for 1 year)

Measurement lines	Single-phase 2-wires, single-phase 3-wires, 3-phase 3-wires, (voltage / current measurement range set for each wiring mode)
Measurement items	Voltage, Current, Active power, Apparent power, Reactive power, Power factor, Phase angle, Frequency, Efficiency, Current integration, Active power integration, Integrated time, Voltage waveform peak value, Current waveform peak value, Voltage crest factor, Current crest factor, Time average current, Time average active power, Voltage ripple factor, Current ripple factor
Harmonic parameters	Synchronization frequency range: 10 Hz to 640 Hz, Analysis order up to 50th Harmonic voltage RMS value, Harmonic current RMS value, Harmonic active power, Total harmonic voltage distortion, Total harmonic current distortion, Voltage fundamental waveform, Current fundamental waveform, Active power fundamental waveform, Apparent power fundamental waveform, Reactive power fundamental waveform, Power factor fundamental waveform (displacement power factor), Voltage current phase difference fundamental waveform, Interchannel voltage fundamental wave phase difference, Interchannel current fundamental wave phase difference, Harmonic voltage content %, Harmonic current content %, Harmonic active power content % (The following parameters can be downloaded as data during PC communication but not displayed: Harmonic voltage phase angle, Harmonic current phase angle, Harmonic voltage current phase difference)
Measurement range(*2)	[Voltage] 0.15 V to 1000 V AC/DC [Current] Direct input: 2 mA to 65 A AC/DC For AC/DC measurement using the CT6877A as an example: 4 A to 2000 A AC/DC (typical accuracy $\pm 0.348\%$ ) For AC measurement using the CT9667-01 as an example: 10 A to 5000 A AC (typical accuracy $\pm 2.6\%$ )
Integration measurement (Integration time up to 10,000 hours)	[Current] No. of displayed digits: 6 digits (from 0.00000 mA, Polarity-independent integration and Sum value) [Active power] No. of displayed digits: 6 digits (from 0.00000 mWh, Polarity-independent integration and Sum value)
Input resistance (50/60 Hz)	[Voltage] 2 M $\Omega$ , [Current] 1 m $\Omega$ or less (direct input)
Basic accuracy (Active power)	$\pm 0.1\%$ rdg $\pm 0.1\%$ f.s. (DC) $\pm 0.1\%$ rdg $\pm 0.05\%$ f.s. (45 Hz to 66 Hz, at Input < 50% f.s.) $\pm 0.15\%$ rdg (45 Hz to 66 Hz, at 50% f.s. $\leq$ Input)
Display refresh rate	5 times/s to 20 seconds (depend on average times settings)
Frequency characteristics	DC, 0.1 Hz to 100 kHz
D/A output (-02/-03 model only)	16 channels (selectable from following items): Level output DC $\pm 2$ V, Waveform output 1 V f.s. Level output, instantaneous waveform output (voltage, current, active power), Level output (apparent power, reactive power, power factor, or other), High-speed active power level output
Functions	[Rectification method] AC+DC, AC+DC Umn, AC, DC, FND, Auto-range, Average, VT or CT ratio settings, Synchronized control, MAX/MIN, or other functions
Interfaces	RS-232C / LAN standard, (-01/-03 model also includes GP-IB)
Power supply	100 to 240 V AC, 50/60 Hz, 40 VA max.
Dimensions and mass	305 mm (12.01 in)W $\times$ 132 mm (5.20 in)H $\times$ 256 mm (10.08 in)D, 5.2 kg (183.4 oz)
Included accessories	Instruction manual $\times 1$ , Measurement guide $\times 1$ , Power cord $\times 1$

(\*2) MIN./MAX. current values and accuracy will vary depending on the current sensor used.

#### Shared options for the POWER METER PW3337, PW3336, and PW3335 series

## Measure AC/DC Standby Power Up to Large Power Loads

### POWER METER PW3335



- Compatible with the SPECpower® benchmark for server power consumption  
SPECpower® is a registered trademark of Standard Performance Evaluation Corporation
- High-precision  $\pm 0.1\%$  basic accuracy (For complete details, please refer to the specifications)
- Wide 1mA to 20A measurement range, max. continuous input of 30 A
- Wide frequency bandwidth of 0.1 Hz to 100 kHz or DC
- Measure harmonic and standby power consumption according to IEC62301
- Achieve superior accuracy even with a low power factor for no-load testing of transformers and motors
- Synchronized control using up to 8 instruments
- Built-in external sensor input terminals to measure up to 5000 A AC (PW3335-03, PW3335-04 only)
- Send measured values to HIOKI data loggers using a Bluetooth® wireless technology compatible adapter (LR8410 Link-compatible products, Ver. 1.1 and later, the PW3335-01 is not supported)

Model No. (Order Code)	<b>PW3335</b>	(Built-in LAN, RS-232C)
	<b>PW3335-01</b>	(Built-in LAN, GP-IB)
	<b>PW3335-02</b>	(Built-in LAN, RS-232C, D/A output)
	<b>PW3335-03</b>	(Built-in LAN, RS-232C, external sensor terminal)
	<b>PW3335-04</b>	(Built-in LAN, RS-232C, GP-IB, D/A output, external sensor terminal)

#### Basic specifications (Accuracy guaranteed for 1 year)

Measurement lines	Single-phase/ two-wires
Measurement items	Voltage, current, active power, apparent power, reactive power, power factor, phase angle, frequency, maximum current ratio, current integration, active power integration, integration time, voltage waveform peak value, current waveform peak value, voltage crest factor, current crest factor, time average current, time average active power, voltage ripple rate, current ripple rate
Harmonic parameters	Synchronization frequency range: 10 Hz to 640 Hz Maximum analysis order: 50th Harmonic voltage RMS value, harmonic current RMS value, harmonic active power, total harmonic voltage distortion, total harmonic current distortion, fundamental wave voltage, fundamental wave current, fundamental wave active power, fundamental wave apparent power, fundamental wave reactive power, fundamental wave power factor (displacement power factor), fundamental wave voltage current phase difference, harmonic voltage content percentage, harmonic current content percentage, harmonic active power content percentage (The following parameters can be downloaded as data with only PC communications: Harmonic voltage phase angle, harmonic current phase angle, harmonic voltage current phase difference)
Measurement ranges	[Voltage] AC/DC 6 V to 1000 V, 8 ranges [Current] AC/DC 1 mA to 20 A, 14 ranges [Power] 6.0000 mW to 20.000 kW (Depends on combination of voltage and current range) Effect of power factor: $\pm 0.1\%$ f.s. or less (45 to 66 Hz, at power factor = 0)
Integration measurement (Integration time up to 10,000 hours)	Switchable between fixed-range integration and auto-range integration. [Current] No. of displayed digits: 6 digits (from 0.00000 mA, polarity-independent integration and sum value) [Active power] No. of displayed digits: 6 digits (from 0.00000 mW, polarity-independent integration and sum value)
Input resistance (50/60 Hz)	[Voltage input terminal] 2 M $\Omega$ [Current input terminal] 520 m $\Omega$ or less (at 1 mA to 100 mA range), 15 m $\Omega$ or less (at 200 mA to 20 A range)
Basic accuracy (Active power)	$\pm 0.1\%$ rdg $\pm 0.1\%$ f.s. (DC) $\pm 0.1\%$ rdg $\pm 0.05\%$ f.s. (45 Hz to 66 Hz, at input < 50% f.s.) $\pm 0.15\%$ rdg (45 Hz to 66 Hz, at 50% f.s. $\leq$ input)
Display refresh rate	5 times/s to 20 seconds (depend on average times settings)
Frequency characteristics	DC, 0.1 Hz to 100 kHz
D/A output (-02/-04 models only)	7 channels (selectable from the following items): level output DC $\pm 2$ V f.s. or 5 V f.s., waveform output 1 V f.s., level output, instantaneous waveform output (voltage, current, active power), level output (apparent power, reactive power, power factor, or other), high-speed level output (voltage, current, active power)
Functions	[Rectification method] AC+DC, AC+DC Umm, AC, DC, FND, Auto-range, Average, VT or CT ratio settings, Synchronized control, MAX/MIN, and more
Logger connectivity	Sends measured values wirelessly to logger by using a Bluetooth® wireless technology serial conversion adapter. (Supported devices: Hioki LR8410 Link-compatible loggers), Ver. 1.1 and later, the PW3335-01 is not supported
Interfaces	LAN (all models), RS-232C (except -01 model, for communication/LR8410 link), GP-IB (-01, -04 models only)
Power supply	100 V to 240 V AC, 50/60 Hz, 30 VA max.
Dimensions and mass	210 mm (8.27 in)W $\times$ 100 mm (3.94 in)H $\times$ 245 mm (9.65 in)D, 3 kg (105.8oz)
Included accessories	Instruction manual $\times 1$ , power cord $\times 1$ , voltage and current input terminal safety cover $\times 2$ , safety cover installation screws (M3 $\times$ 6 mm) $\times 4$

### Shared options for the POWER METER PW3337, PW3336, and PW3335 series ...(\*PW3335 is available only for models with external current sensor input terminals, current sensor can be used)

Current sensors are compatible only with versions of Model PW3335 that include the external current sensor terminal.  
Can be connected to the current sensor input terminals (1 sensor necessary for single-phase measurement, and 2 or 3 sensors required for 3-phase measurements)

	<b>CLAMP ON SENSOR 9660</b> 100A AC rated current, $\phi$ 15 mm (0.59 in) core dia., 3 m (9.84 ft) length		<b>CLAMP ON SENSOR 9661</b> 500A AC rated current, $\phi$ 46 mm (1.81 in) core dia., 3 m (9.84 ft) length		<b>FLEXIBLE CLAMP ON SENSOR CT9667-01/-02/-03</b> 500/500 A AC rated current, $\phi$ 100 mm (3.94 in) to 254 mm (10.0 in) core dia., Cable length: Between sensor-box 2 m (6.56 ft), Output cable 1 m (3.28 ft)		<b>CLAMP ON SENSOR 9669</b> 1000A AC rated current, $\phi$ 55 mm (2.17 in) core dia., 3 m (9.84 ft) length
--	--	--	--	--	--	--	---

\*Current sensors are compatible only with versions of Model PW3335 that include the external current sensor terminal.  
\*To use, requires Sensor Unit CT9555 and Connection Cord L9217.  
\*1 sensor necessary for single-phase measurement, 2 or 3 sensors required for 3-phase measurements. The same number of power supply and connection cord as the sensor is necessary.

High-Precision Current Sensors	<b>Up to 50 A (High precision)</b>	<b>AC/DC CURRENT SENSOR CT6872</b> High accuracy pass-through, DC to 10 MHz, 50 A input, $\pm 0.03\%$ amplitude accuracy, $\pm 0.05^\circ$ phase accuracy, ME15W terminal	<b>AC/DC CURRENT SENSOR CT6862-05</b> High-precision pull-through type, DC to 1 MHz, 50 A input, $\pm 0.05\%$ amplitude accuracy, $\pm 0.2^\circ$ phase accuracy, ME15W terminal	<b>AC/DC CURRENT PROBE CT6841A</b> DC to 1 MHz, 20 A input, $\pm 0.2\%$ amplitude accuracy, $\pm 0.1^\circ$ phase accuracy, ME15W terminal
	<b>Up to 200 A (High precision)</b>	<b>AC/DC CURRENT SENSOR CT6873</b> High accuracy pass-through, DC to 10 MHz, 200 A input, $\pm 0.03\%$ amplitude accuracy, $\pm 0.05^\circ$ phase accuracy, ME15W terminal	<b>AC/DC CURRENT SENSOR CT6863-05</b> High-precision pull-through type, DC to 500 kHz, 200 A input, $\pm 0.05\%$ amplitude accuracy, $\pm 0.2^\circ$ phase accuracy, ME15W terminal	<b>AC/DC CURRENT PROBE CT6843A</b> DC to 500 kHz, 200 A input, $\pm 0.2\%$ amplitude accuracy, $\pm 0.1^\circ$ phase accuracy, ME15W terminal
	<b>Up to 1000 A (High precision)</b>	<b>AC/DC CURRENT SENSOR CT6876A</b> High-precision pull-through type, DC to 1.5 MHz, 1000 A input, $\pm 0.04\%$ amplitude accuracy, $\pm 0.08^\circ$ phase accuracy, ME15W terminal	<b>AC/DC CURRENT PROBE CT6846A</b> DC to 20 kHz, 1000 A input, $\pm 0.2\%$ amplitude accuracy, $\pm 0.1^\circ$ phase accuracy, ME15W terminal	
	<b>Up to 2000 A (High precision)</b>	<b>AC/DC CURRENT SENSOR CT6877A</b> High-precision pull-through type, DC to 1 MHz band width, 2000 A input, $\pm 0.04\%$ amplitude accuracy, $\pm 0.08^\circ$ phase accuracy, ME15W terminal		
	<b>PL23 (10 pin) - ME15W (12 pin) conversion</b>	<b>CONVERSION CABLE CT9900</b> Convert PL23 (10-pin) terminal to ME15W (12-pin) terminal		
	<b>Power supply for sensors</b>	<b>SENSOR UNIT CT9555</b> 1ch, with Waveform output	<b>CONNECTION CORD L9217</b> Cord has insulated BNC connectors at both ends, 1.6 m (5.25 ft) length	

PC communication	<b>LAN CABLE 9642</b> Straight Ethernet cable, supplied with straight to cross conversion adapter, 5 m (16.41 ft) length	<b>RS-232C CABLE 9637</b> For the PC, 9pin - 9pin, cross, 1.8m (5.91 ft) length
	<b>GP-IB CONNECTOR CABLE 9151-02</b> 2m (6.56 ft) length	
	<b>Synchronize Multiple Units</b>	
Other options	<b>CONNECTION CORD 9165</b> Cord has metallic BNC connectors at both ends, use at metallic terminal, 1.5 m (4.92 ft) length	

## Single Phase Power Meter Compatible with DC Measurement and Current/Power Integration Measurement

### AC/DC POWER HiTESTER 3334



- Compatible with the SPECpower® benchmarking for server power consumption  
SPECpower® is a registered trademark of Standard Performance Evaluation Corporation
- DC measurement mode, AC, and AC+DC measurement
- Integration function for current and power
- ±0.1% high basic accuracy (For complete details, please refer to the specifications)
- Extended period of guaranteed accuracy of 3 years
- Complete accuracy over a wide input range

Model No. (Order Code) **3334**  
**3334-01** (Built-in GP-IB)

#### ■ Basic specifications (Accuracy guaranteed for 1 year)

Measurement lines	Single-phase/ two-wires
Measurement items	Voltage, Current, Active power, Apparent power, Power factor, Frequency, Integration (current, active power), Waveform peak (voltage and current)
Measurement ranges	[Voltage] AC/DC 15.000/ 30.00/ 150.00/ 300.0 V [Current] AC/DC 100.00/ 300.0 mA, 1.00000/ 3.000/ 10.000/ 30.00 A [Power] 1.5000 W to 9.000 kW (combination of voltage and current ranges)
Integration measurement	[Current] No. of displayed digits: 6 digits (from 0.00000 mAh, Polarity-independent integration and Sum value)
Integration time up to 10,000 hours	[Active power] No. of displayed digits: 6 digits (from 0.00000 mWh, Polarity-independent integration and Sum value)
Input resistance (50/60 Hz)	[Voltage] 2.4 MΩ, [Current] 10 mΩ or less (direct input)
Basic accuracy	±0.1% rdg ±0.2% f.s. (DC), ±0.1% rdg ±0.1% f.s. (45 Hz to 66 Hz) <i>Note: Provided accuracy of 1 Year, typical value</i>
Display refresh rate	5 times/s
Frequency characteristics	DC, 45 Hz to 5 kHz
Waveform output	Parameter output representation: voltage, current and power (3 simultaneous channels), Output voltage: 1 V DC f.s.
Analog output (D/A output)	Parameter output representation: voltage, current active power and selected 1 item (4 simultaneous channels), Selected 1 item from apparent power, power factor, current integration, active power integration, Output voltage: ±2 V DC f.s.
Functions	Rectification method switchable between AC+DC (True RMS), DC (simple average), AC (True RMS), Wave peak measurement, VT or CT ratio settings, Average function
Interfaces	RS-232C included as standard, GP-IB (Model 3334-01 only)
Power supply	100 V to 240 V AC, 50/60 Hz, 20 VA max.
Dimensions and mass	210 mm (8.27 in)W × 100 mm (3.94 in)H × 245 mm (9.65 in)D, 2.5 kg (88.2 oz)
Included accessories	Instruction manual ×1, Power cord ×1

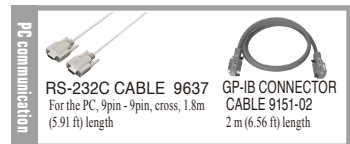

## Single Phase Power Meter for Production and Inspection Lines

### POWER HiTESTER 3333



- Ideal for replacing portable instruments, ±0.1% basic accuracy
- Extended period of guaranteed accuracy of 3 years
- 50mA to 20A AC current range (300 V Max., Accuracy guaranteed up to 30 A)
- RS-232C interface

Model No. (Order Code) **3333**  
**3333-01** (Built-in GP-IB)

#### ■ Basic specifications (Accuracy guaranteed for 1 year)

Measurement lines	Single-phase 2-wires
Measurement items	Voltage, Current, Active power, Apparent power, Power factor
Measurement range	[Voltage] 200 V AC (300 V Max.) [Current] 50/ 200/ 500 mA, 2/ 5/ 20 A AC (30 A Max.) [Power] 10.000 W to 4.000 kW (combination of voltage and current ranges)
Input resistance (50/60 Hz)	[Voltage] 2.4 MΩ, [Current] 7 mΩ or less (direct input)
Basic accuracy	[Guaranteed for 1 year, Voltage, Current, Active power] ±0.1 % rdg ±0.1 % f.s. (45 Hz to 66 Hz, input current 20 A or less) [Guaranteed for 3 years, Voltage, Current, Active power] ±0.1 % rdg ±0.2 % f.s. (45 Hz to 66 Hz, input current 20 A or less)
Display refresh rate	5 times/s
Frequency characteristics	45 Hz to 5 kHz
D/A output	3 channels outputs simultaneously for voltage, current, active power +2 V DC f.s.
Functions	Scaling (VT, CT ratio settings), Average function
Interfaces	RS-232C standard, GP-IB (Model 3333-01 only)
Power supply	100 to 240 V AC, 50/60 Hz, 20 VA max.
Dimensions and mass	160 mm (6.30 in)W × 100 mm (3.94 in)H × 227 mm (8.94 in)D, 1.9 kg (67.0 oz)
Included accessories	Instruction manual ×1, Power cord ×1

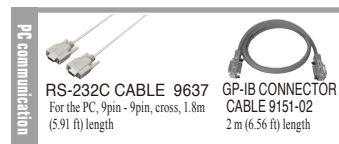

## Investigate Power Characteristics and Analyze the Causes of Problems

### POWER QUALITY ANALYZER PQ3198



Current sensors : Sold separately



- Verify power problems in accordance with the IEC61000-4-30 Class A standard
- High accuracy and continuous gapless recording  
(V:  $\pm 0.1\%$  of nominal voltage, A:  $\pm 0.1\%$  rdg  $\pm 0.1\%$  f.s., W:  $\pm 0.2\%$  rdg  $\pm 0.1\%$  f.s.)
- Broadband voltage range lets you measure even high-order harmonic (supraharmonic) components of up to 80 kHz
- Maximum 6000 V peak transient voltage up to 700 kHz
- Measure up to 6000 A AC
- Two systems of power measurement and efficiency calculation for (ch 1, ch 2, ch 3) and ch 4
- Make simple measurements of inverters with 40 to 70 Hz fundamental frequency and max. 20 kHz carrier frequency
- Easily create reports with bundled PQ ONE application software
- Optional GPS BOX for synchronizing multiple devices

Model No. (Order Code) **PQ3198** (Main unit, current sensor is sold separately)

Note: An optional current sensor is necessary to measure current or power parameters. Select from Value Kits for added savings.

#### POWER QUALITY ANALYZER PQ3198 VALUE KITS :

Model No. (Order Code) (Note)

**PQ3198-92** (Kit includes 600 A sensor  $\times$  4 and other options)

Kit contents: Main unit, AC Current sensor CT17136 (600 A)  $\times$  4, Patch Cord L1021-02  $\times$  3, Carrying Case C1009

**PQ3198-94** (Kit includes 6000 A sensor  $\times$  4 and other options)

Kit contents: Main unit, AC Current sensor CT17045 (6000 A)  $\times$  4, Patch Cord L1021-02  $\times$  3, Carrying Case C1009

#### Basic specifications (Accuracy guaranteed for 1 year)

Measurement line type	Single-phase 2-wire, Single-phase 3-wire, Three-phase 3-wire or Three-phase 4-wire plus one extra input channel for voltage, current, power measurement (AC or DC measurement)
Voltage ranges	Voltage measurement: 600.00 V rms Transient measurement 6.0000 kV peak
Current ranges	500.00 mA to 5.0000 kA AC (depends on current sensor in use)
Power ranges	300.00 W to 3.0000 MW (determined automatically based on voltage and current range in use)
Basic accuracy	Voltage: $\pm 0.1\%$ of nominal voltage Current: $\pm 0.1\%$ rdg $\pm 0.1\%$ f.s. + current sensor accuracy Active power: $\pm 0.2\%$ rdg $\pm 0.1\%$ f.s. + current sensor accuracy
Measurement items	1. Transient voltage : 2 MHz sampling 2. Frequency cycle : Calculated as one cycle, 40 to 70 Hz 3. Voltage (1/2) RMS: one cycle calculation refreshed every half cycle Current (1/2) RMS: half-cycle calculation 4. Voltage swell, Voltage dips, Voltage interruption 5. Inrush current 6. Voltage waveform comparison 7. Instantaneous flicker value: As per IEC61000-4-15 8. 200 ms frequency: Calculated as 10 or 12 cycles, 40 to 70 Hz 9. 10 sec frequency: Calculated as the whole-cycle time during the specified 10 s period, 40 to 70 Hz 10. Voltage waveform peak, Current waveform peak 11. Voltage, Current, Active power, Apparent power, Reactive power, Active energy, Reactive energy, Power factor, Displacement power factor, Voltage unbalance factor, Current unbalance factor, and efficiency 12. High-order harmonic (supraharmonic) component (voltage/ current): 2 kHz to 80 kHz 13. Harmonic/ Harmonic phase angle (voltage/ current), Harmonic power: 0th to 50th orders 14. Harmonic voltage-current phase angle: 1th to 50th orders 15. Total harmonic distortion factor (voltage/ current) 16. Inter harmonic (voltage/ current): 0.5 th to 49.5 th order 17. K Factor (multiplication factor) 18. IEC Flicker, $\Delta$ V10 Flicker 19. Mains signaling voltage
Record	Repeated ON: 1 year, Maximum recording event: 9999 $\times$ 366 days (up to 9999 events per day) Repeated off: 35 days, maximum recording event: 9999 events
Interfaces	SD/SDHC memory card, LAN (HTTP server function / FTP function), USB2.0 (for communication)
Display	6.5-inch TFT color LCD (640 $\times$ 480 dots)
Power supply	AC adapter Z1002 (100 V to 240 V AC, 50/60 Hz, rated current 1.7 A), Battery Pack Z1003 (Continuous use: 180 minutes, Charging time: Max. 5 hr 30 m with AC adapter)
Dimensions and mass	300 mm (11.81 in)W $\times$ 211 mm (8.31 in)H $\times$ 68 mm (2.68 in)D, 2.6 kg (91.7 oz) (including Battery Pack Z1003)
Included accessories	Instruction manual $\times$ 1, Measurement guide $\times$ 1, Voltage Cord L1000 $\times$ 1 set (Red/ Yellow/ Blue/ Gray each 1, Black 4, 3m (9.84ft) length, Alligator clip $\times$ 8), Color clip, AC Adapter Z1002 $\times$ 1, Strap $\times$ 1, USB cable (1 m 3.28 ft length) $\times$ 1, Battery pack Z1003 $\times$ 1, SD Memory Card 2GB Z4001 $\times$ 1, Application software (PQ ONE) $\times$ 1

## Quick and Simple Power Quality Testing, Record and Analyze Power Supply Issues with a Single Instrument

### POWER QUALITY ANALYZER PQ3100



Current sensors : Sold separately



- Record data including voltage, current, power, harmonics, and flicker simultaneously along a single time axis
- Measure up to 6000 A AC
- Capture all power anomalies, including instantaneous outages, voltage drops, and frequency fluctuations, while simultaneously recording trend data
- Quick Set: Easy-to-understand on-screen guide for measurement procedures
- Bundled PQ ONE application software makes it easy to create reports
- Record waveforms for up to 1 second before and 10 seconds after an anomaly occurs
- Accurately measure DC currents over extended periods of time (with an AC/DC auto-zero current sensor)
- Directly supply power to connected current sensors
- Send measured values to HIOKI data loggers using a Bluetooth<sup>®</sup> wireless technology compatible adapter (LR8410 Link-compatible products), Ver. 2.0 and later

Model No. (Order Code) **PQ3100** (Main unit, clamp sensor is sold separately)

Note: An optional current sensor is necessary to measure current or power parameters. Select from Value Kits for added savings.

#### POWER QUALITY ANALYZER PQ3100 VALUE KITS :

Model No. (Order Code) (Note)

**PQ3100-91** (Kit includes 600 A sensor  $\times$  2 and other options)

Kit contents: AC Current sensor CT17136 (600 A)  $\times$  2, PQ3100 main unit, SD Memory card 2GB Z4001, Carrying case C1009

**PQ3100-92** (Kit includes 600 A sensor  $\times$  4 and other options)

Kit contents: AC Current sensor CT17136 (600 A)  $\times$  4, PQ3100 main unit, SD Memory card 2GB Z4001, Carrying case C1009

**PQ3100-94** (Kit includes 6000 A sensor  $\times$  4 and other options)

Kit contents: AC Flexible current sensor CT17045 (6000 A)  $\times$  4, PQ3100 main unit, SD Memory card 2GB Z4001, Carrying case C1009



PQ3100-91 Value Kit

#### Basic specifications (Accuracy guaranteed for 1 year)

Measurement line type	Single-phase 2-wire, Single-phase 3-wire, Three-phase 3-wire or Three-phase 4-wire plus one extra input channel CH4 for voltage/current, (all channels AC/DC measurement)
Voltage ranges	Voltage measurement: 1000.0 V rms or DC, Transient measurement 2.200 kV peak
Current ranges	50.000 mA AC to 5.0000 kA AC, 10.000 A DC to 2.0000 kA DC (depends on current sensor in use)
Power ranges	50.000 W to 6.0000 MW (determined automatically based on current range in use)
Basic accuracy	Voltage: $\pm 0.2\%$ of nominal voltage, Current: $\pm 0.1\%$ rdg $\pm 0.1\%$ f.s. + current sensor accuracy, Active power: DC $\pm 0.5\%$ rdg $\pm 0.5\%$ f.s. + current sensor accuracy, AC $\pm 0.2\%$ rdg $\pm 0.1\%$ f.s. + current sensor accuracy
Measurement items	1. Transient over voltage : 200 kHz sampling 2. Frequency cycle : Calculated as one cycle 3. Voltage (1/2) RMS, Current (1/2) RMS: one cycle calculation refreshed every half cycle 4. Voltage swell, Voltage dips, Voltage interruption, RVC (Ver. up) : Voltage (1/2) RMS calculation 5. Inrush current : half-cycle calculation: Calculated as the current RMS value for current waveform data sampled every half-cycle. 6. Frequency 200 ms: Calculated as one cycle 7. 10-sec frequency: Calculated as the whole-cycle time during the specified 10 s period 8. Voltage waveform peak, Current waveform peak 9. Voltage, Current, Active power, Apparent power, Reactive power, Active energy, Apparent energy, Reactive energy, Energy cost, Power factor, Displacement power factor, Voltage unbalance factor, Current unbalance factor 10. Voltage crest factor, Current crest factor 11. Harmonic/ Harmonic phase angle (voltage/ current), Harmonic power: 0 th to 50 th orders 12. Harmonic voltage-current phase angle: 1 th to 50 th orders 13. Total harmonic distortion factor (voltage/ current) 14. Inter harmonic (voltage/ current): 0.5 th to 49.5 th orders 15. K Factor (multiplication factor) 16. IEC Flicker, $\Delta$ V10 Flicker
Record	Maximum recording interval: 1 year, Maximum number of recordable events: 9999 $\times$ 365 days
Interfaces	SD/SDHC memory card, RS-232C (for communication/ LR8410 link), LAN (HTTP server/ FTP / Send e-mail), USB 2.0 (for communication)
Logger connectivity	Sends measured values wirelessly to logger by using a Bluetooth <sup>®</sup> wireless technology serial conversion adapter. (Supported devices: Hioki LR8410 Link-compatible loggers), Ver. 2.0 and later
Display	6.5-inch TFT color LCD (640 $\times$ 480 dots)
Power supply	AC adapter Z1002 (100 V to 240 V AC, 50/60 Hz, rated current 1.7 A), Battery pack Z1003 (Continuous use: 8 hr, Charging time: Max. 5 hr 30 m with AC adapter)
Dimensions and mass	300 mm (11.81 in)W $\times$ 211 mm (8.31 in)H $\times$ 68 mm (2.68 in)D, 2.5 kg (88.2 oz) (including battery pack)
Included accessories	Instruction manual $\times$ 1, Measurement guide $\times$ 1, Voltage cord L1000-05 $\times$ 1 set (Red/ Yellow/Blue/Gray/Black, Alligator clip $\times$ 5, Spiral tube $\times$ 5), Color clip (for identifying clamp sensor color) $\times$ 1 set, Spiral tube $\times$ 5, AC adapter Z1002 $\times$ 1, Strap $\times$ 1, USB cable (1 m 3.28 ft length) $\times$ 1, Battery pack Z1003 $\times$ 1, PQ ONE (software, CD) $\times$ 1

# Power Quality Analyzers

## Shared options for the PQ3198 / PQ3100

For power or load current measurement (1 sensor necessary for single-phase measurements, and 2 or 3 sensors required for 3-phase measurements)

<b>Current input</b>  <b>AC CURRENT SENSOR CT7126</b> 60 A AC, φ15 mm (0.59 in), 2.5 m (8.20 ft) cord length	 <b>AC CURRENT SENSOR CT7131</b> 100 A AC, φ15 mm (0.59 in), 2.5 m (8.20 ft) cord length	 <b>AC CURRENT SENSOR CT7136</b> 600 A AC, φ46 mm (1.81 in), 2.5 m (8.20 ft) cord length	 <b>AC FLEXIBLE CURRENT SENSOR CT7044</b> 6000 A AC, φ100 mm (3.94 in), 2.5 m (8.20 ft) cord length	 <b>AC FLEXIBLE CURRENT SENSOR CT7045</b> 6000 A AC, φ180 mm (7.09 in), 2.5 m (8.20 ft) cord length	 <b>AC FLEXIBLE CURRENT SENSOR CT7046</b> 6000 A AC, φ254 mm (10.00 in), 2.5 m (8.20 ft) cord length
---	--	--	---	---	--

\*For leak current measurement (not capable of power measurement)

<b>Leak current input</b>  <b>AC LEAKAGE CURRENT SENSOR CT7116</b> 6 A AC, φ40 mm (1.57 in), 2.5 m (8.20 ft) cord length
---

<b>AC/DC current input</b>  <b>AC/DC AUTO-ZERO CURRENT SENSOR CT7731</b> 100 A AC/DC, φ33 mm (1.30 in), 2.5 m (8.20 ft) cord length	 <b>AC/DC AUTO-ZERO CURRENT SENSOR CT7736</b> 600 A AC/DC, φ33 mm (1.30 in), 2.5 m (8.20 ft) cord length	 <b>AC/DC AUTO-ZERO CURRENT SENSOR CT7742</b> 2000 A AC/DC, φ55 mm (2.17 in), 2.5 m (8.20 ft) cord length	 <b>EXTENSION CABLE L0220-01</b> 2 m (6.56 ft) length	 <b>EXTENSION CABLE L0220-02</b> 5 m (16.41 ft) length	 <b>EXTENSION CABLE L0220-03</b> 10 m (32.81 ft) length
--	--	---	---	--	---

\*The Z4001 is bundled to PQ3198 only

**Storage media**

**SD Card Precaution**

Use only the SD Card sold by HIOKI. Compatibility and performance are not guaranteed for SD cards made by other manufacturers. You may be unable to read from or save data to such cards.

**SD MEMORY CARD**

2GB Z4001 2 GB capacity  
8GB Z4003 8 GB capacity

For PQ3100 only  
\*The L1000-05 is bundled with PQ3100  
\*Please inquire about voltage cord extension

**VOLTAGE CORD L1000-05**  
Red/ Yellow/ Blue/ Gray/ Black each 1, 3 m (9.84 ft) length, Alligator clip ×5

For PQ3198 only \*The L1000 is bundled with PQ3198 \*Please inquire about voltage cord extension

**VOLTAGE CORD L1000**  
Red/ Yellow/ Blue/ Gray each 1, Black 4, 3m (9.84ft) length, Alligator clip ×8

**WIRING ADAPTER PW9000**  
When three-phase 3-wire (3P3W3M) connection, the voltage cord to be connected can be reduced from 6 to 3

**WIRING ADAPTER PW9001**  
When three-phase 4-wire (3P4W) connection, the voltage cord to be connected can be reduced from 6 to 4

**PATCH CORD L1021-01**  
Banana branch-banana, Red: 1, Cable length: 0.5 m, For branching from the L9438s or L1000s, CAT IV 600 V, CAT III 1000 V

**PATCH CORD L1021-02**  
Banana branch-banana, Black: 1, Cable length: 0.5 m, For branching from the L9438s or L1000s, CAT IV 600 V, CAT III 1000 V

Shared options for the PQ3100 / PQ3198

**Voltage input**

**GRABBER CLIP L9243**  
Attaches to the tip of the banana plug cable, Red/ Black: 1 each, 185 mm (7.28 in) length, CAT II 1000 V

**MAGNETIC ADAPTER 9804-01**  
Attaches to the tip of cord, red ×1, φ11 mm (0.43 in)

**MAGNETIC ADAPTER 9804-02**  
Attaches to the tip of cord, black ×1, φ11 mm (0.43 in)

\*The Z1002, Z1003 are bundled

**Power supply**

**AC ADAPTER Z1002**  
For main unit, 100 to 240 V AC

**BATTERY PACK Z1003**  
NiMH, Charges while installed in the main unit

**Other options**

**LAN CABLE 9642**  
Straight Ethernet cable, supplied with straight to cross conversion adapter, 5 m (16.41 ft) length

**CONVERSION CABLE L9910**  
Used to connect the current sensors with BNC terminal to PL14 terminal (example the PQ3100)

Shared options for the PQ3100 / PQ3198

**PC peripherals**

**GENNECT One SF4000**  
Application for Windows

For PQ3100 only

**RS-232C CABLE 9637**  
For the PC, 9 pin - 9 pin, cross, 1.8 m (5.91 ft) length

When using with PQ3100 / PQ3198, suspend the main body on the metal surface using two Z5020 powerful type. Z5004 hang the cords on the metal surface.

**Hands-free options**

**MAGNETIC STRAP Z5020**  
Heavy-duty

**MAGNETIC STRAP Z5004**

**Cases**

**CARRYING CASE C1002**  
Hard trunk type, Includes compartment for options

**CARRYING CASE C1009**  
Bag type, Includes compartment for options

**Waterproof Box**  
For outdoor installation; IP65 compliant, Contact Hioki for a quotation.

For PQ3198 only

**Time synchronization**

**GPS BOX PW9005**  
To synchronize the PQ3198 / PW3198 clock to UTC

## Eliminate the Risk of Short-Circuits and Electrical Accidents

### CLAMP ON POWER LOGGER PW3365



- Voltage measurement from the top of the cable, zero risk of short circuit
- Supports single to three-phase, 4-wire circuits
- Measure between 90V to 520V
- Display harmonics up to the 13th order
- Slim, compact design that can be placed anywhere
- Store months of data on SD cards
- The QUICK SET function guides you in making the right connections

Model No. (Order Code) **PW3365-20** (English model, main unit only)

Note: Clamp On Power Logger PW3365-20 by itself does not support current and power measurements. Current and power measurements require clamp on sensors, sold separately. Use only HIOKI SD cards guaranteed to work for saving measurement data (options, sold separately).

#### ■ SAFETY VOLTAGE SENSOR PW9020 Specifications

Compatible conductor types	Insulated wires*, in door PVC or metal parts *Shielded wires cannot be measured. The product may not be able to accurately measure multi-core cables or cables that have thick insulation.
Compatible conductor diameters	Finished outer diameter φ 6 mm to φ 30 mm
Effective measurement range	90 V rms to 520 V rms
Cord length	3 m (9.84 ft)

#### ■ Basic specifications (Accuracy guaranteed for 1 year)

Measurement line & number of circuits	50/60 Hz, Single phase 2 wires (1/2/3 circuits), Single phase 3 wires (1 circuit), Three phases 3 wires (1 circuit), Three phases 4 wires (1 circuit), Current only: 1 to 3 channels
Measurement items	Voltage RMS, current RMS, voltage fundamental wave value, current fundamental wave value, voltage fundamental wave phase angle, current fundamental wave phase angle, frequency (UI), voltage waveform peak (absolute value), current waveform peak (absolute value), active power, reactive power, apparent power, power factor (with lag/lead display) or displacement power factor (with lag/lead display), active energy (consumption, regeneration), reactive energy (lag, lead), energy cost display, active power demand quantity (consumption, regeneration), reactive power demand quantity (lag, lead), active power demand value (consumption, regeneration), reactive power demand value (lag, lead), power factor demand
Harmonic	Harmonic voltage, harmonic current, voltage total harmonic distortion (THD-F or THD-R), current total harmonic distortion (THD-F or THD-R), up to 13th order
Voltage ranges	400 V AC (Effective measurement range: 90.0 V to 520.0 V)
Current ranges	500.00 mA to 5.0000 kA AC (depends on current sensor in use), 50.000 mA to 5.0000 A AC (Leak clamp on sensor only)
Power ranges	200.00 W to 6.0000 MW (depends on voltage/current combination and measured line type)
Basic accuracy	Voltage: ±1.5% rdg ±0.2% f.s.(combined accuracy with PW3365-20 + PW9020) Current: ±0.3% rdg ±0.1% f.s. + clamp sensor accuracy Active power: ±2.0% rdg ±0.3% f.s. + clamp sensor accuracy (at power factor = 1)
Display update rate	0.5 sec (except when accessing SD card or internal memory, or during LAN/USB communication)
Save destination	SD/SDHC Memory card, or internal memory at real time
Data save interval	1 sec to 30 sec, 1 minute to 60 minutes, 14 selections
Save items	Measurement value save: Average only / Average, Maximum, Minimum value Screen copy: BMP form (saved every 5 min. at minimum interval time) Waveform save: Binary waveform data
Interfaces	SD/SDHC memory card, LAN 100BASE-TX: HTTP server function, remote settings via communication program, data download, USB 2.0: When connected to a PC, the SD Card and internal memory are recognized as removable storage devices, remote settings via communication program, data download
Functions	Connection check, Quick Set navigation guide, clock
Power supply	AC adapter Z1008: (100 to 240 V AC, 50/60 Hz), 45 VA (including AC adapter) Battery pack 9459: (DC 7.2 V, 3 VA, charging time 6 hr 10 m), 5 hours of continuous use (with back light off)
Dimensions and mass	180 mm (7.09 in)W × 100 mm (3.94 in)H × 48 mm (1.89 in)D, 540 g (19 oz) without PW9002 180 mm (7.09 in)W × 100 mm (3.94 in)H × 68 mm (2.68 in)D, 820 g (28.9 oz) with PW9002
Included accessories	Safety Voltage Sensor PW9020 ×1 set, AC adapter Z1008 ×1, USB cable ×1, Instruction manual ×1, Measurement guide ×1, Color clip (red, yellow, blue and white each 4), Spiral tubes in black (cord bundling for current sensors and voltage sensors) ×10

Power Analyzers

## Identify Your Power Condition to Reveal Energy Saving Ideas

### CLAMP ON POWER LOGGER PW3360



Current sensors : Sold separately

- Supports single to three-phase, 4-wire circuits
- Measure between 90V to 780V
- Simultaneously measure up to three single-phase, 2-wire circuits (in the same power system)
- Slim, compact design that can be placed anywhere
- Store months of data on SD cards
- The QUICK SET function guides you in making the right connections
- Choose PW3360-21 for harmonic measurements up to the 40th order

Model No. (Order Code) **PW3360-20** (English model, main unit only)  
**PW3360-21** (English model, with harmonic analysis function)

Note: At least one optional current sensor is necessary to measure current or power parameters. To store measurement data, use only the guaranteed SD cards sold by HIOKI.

#### Basic specifications (Accuracy guaranteed for 1 year)

Measurement line & number of circuits	50/60 Hz, Single phase 2 wires (1/2/3 circuits), Single phase 3 wires (1 circuit), Three phases 3 wires (1 circuit), Three phases 4 wires (1 circuit), Current only: 1 to 3 channels
Measurement items	Voltage RMS, current RMS, voltage fundamental wave value, current fundamental wave value, voltage fundamental wave phase angle, current fundamental wave phase angle, frequency (UI), voltage waveform peak (absolute value), current waveform peak (absolute value), active power, reactive power (with lag/lead display), apparent power, power factor (with lag/lead display) or displacement power factor (with lag/lead display), active energy (consumption, regeneration), reactive energy (lag, lead), energy cost display, active power demand quantity (consumption, regeneration), reactive power demand quantity (lag, lead), active power demand value (consumption, regeneration), reactive power demand value (lag, lead), power factor demand, pulse input [PW3360-21 only]: Harmonic voltage level, harmonic current level, harmonic power level, content percentage, phase angle, total harmonic distortion (THD-F or THD-R), up to 40th order
Voltage ranges	600 V AC (Effective measurement range: 90.00 V to 780.00 V)
Current ranges	500.00 mA to 5.0000 kA AC (depends on current sensor in use), 50.0000 mA to 5.0000 A AC (Leak clamp on sensor only)
Power ranges	300.00 W to 9.0000 MW (depends on voltage/current combination and measured line type)
Basic accuracy	Voltage : $\pm 0.3\%$ rdg $\pm 0.1\%$ f.s. Current : $\pm 0.3\%$ rdg $\pm 0.1\%$ f.s. + clamp sensor accuracy Active power : $\pm 0.3\%$ rdg $\pm 0.1\%$ f.s. + clamp sensor accuracy (at power factor = 1)
Display update rate	0.5 sec (except when accessing SD card or internal memory, or during LAN/USB communication)
Save destination	SD Memory card, or internal memory at real time
Data save interval	1 sec to 30 sec, 1 minute to 60 minutes, 14 selections
Save items	Measurement value save: Average only / Average, Max./Min. value, [PW3360-21 only]: Harmonic data save: Average only / average, max./min. value in binary format, Screen copy: BMP form (saved every 5 min. at minimum interval time), Waveform save: Binary waveform data
Interfaces	SD/SDHC memory card, LAN 100BASE-TX: HTTP server function, USB 2.0: When connected to a PC, the SD Card and internal memory are recognized as removable storage devices, remote settings via communication program, data download, Pulse output: proportional to active power consumption when measuring integral power consumption, Isolated open-collector signal
Functions	Connection check, Quick Set navigation guide, clock, pulse input
Power supply	AC adapter Z1006: (100 to 240 V AC, 50/60 Hz), 40 VA (including AC adapter), Battery pack 9459: (DC 7.2 V, 3 VA, charging time 6 hr 10 m), 8 hours of continuous use (with back light off)
Dimensions and mass	180 mm (7.09 in)W × 100 mm (3.94 in)H × 48 mm (1.89 in)D, 550 g (19.4 oz) without PW9002 180 mm (7.09 in)W × 100 mm (3.94 in)H × 67.2 mm (2.65 in)D, 830 g (29.3 oz) with PW9002
Included accessories	Voltage cord L9438-53 ×1 set, AC adapter Z1006 ×1, USB cable ×1, Instruction manual ×1, Measurement guide ×1, Color clip ×1 set: red, yellow, blue, white/two each, for color-coding clamp sensors, Spiral tubes for grouping clamp sensor cords ×5

Power Meters

### Shared options for PW3360, PW3365

<p>Voltage input for PW3360</p> <p>*L9438-53 is bundled with the PW3360-20/-21</p> <p><b>VOLTAGE CORD L9438-53</b> Black/ Red/ Yellow/ Blue, 3 m (9.84 ft) length, Alligator clip ×4</p> <p><b>MAGNETIC ADAPTER 9804-01</b> Attaches to the tip of cord, red ×1, <math>\phi</math>11 mm</p> <p><b>MAGNETIC ADAPTER 9804-02</b> Attaches to the tip of cord, black ×1, <math>\phi</math>11 mm</p> <p><b>PATCH CORD L1021-01</b> Banana branch-banana, Red: 1, Cable length: 0.5 m, For branching from the L9438s or L1000s, CAT IV 600 V, CAT III 1000 V</p> <p><b>PATCH CORD L1021-02</b> Banana branch-banana, Black: 1, Cable length: 0.5 m, For branching from the L9438s or L1000s, CAT IV 600 V, CAT III 1000 V</p>	<p>Storage media</p> <p><b>SD MEMORY CARD 2GB Z4001</b> 2 GB capacity</p> <p><b>SD MEMORY CARD Z4003</b> 8 GB capacity</p> <p><b>SD Card Precaution</b> Use only the SD Card sold by HIOKI. Compatibility and performance are not guaranteed for SD cards made by other manufacturers. You may be unable to read from or save data to such cards.</p>
<p>Voltage input for PW3365</p> <p>*PW9020 ×4 pieces are bundled, additional single sensors also available</p> <p><b>SAFETY VOLTAGE SENSOR PW9020</b> For PW3365, 3 m (9.84 ft) length</p> <p><b>BATTERY SET PW9002</b> Battery case and Battery Pack 9459 Set</p> <p><b>BATTERY PACK 9459</b> NiMH, Charges while installed in the main unit</p>	<p>Power supply for PW3360</p> <p><b>AC ADAPTER Z1006</b> 100 to 240 V AC</p> <p><b>VOLTAGE LINE POWER ADAPTER PW9003</b> For PW3360s, supplies power from measurement lines, up to 240V AC</p>
<p>Shared power supply</p> <p>*The 9459 is a replacement battery pack included with the Battery Set PW9002</p> <p><b>BATTERY SET PW9002</b> Battery case and Battery Pack 9459 Set</p> <p><b>BATTERY PACK 9459</b> NiMH, Charges while installed in the main unit</p>	<p>Power supply for PW3365</p> <p>*Z1006 is bundled with the PW3360</p> <p><b>AC ADAPTER Z1006</b> 100 to 240 V AC</p> <p><b>VOLTAGE LINE POWER ADAPTER PW9003</b> For PW3360s, supplies power from measurement lines, up to 240V AC</p>
<p>Shared case, Other</p> <p>Z5004 hang the cords on the metal surface. C1005 store Current sensor ×2, Voltage sensor ×3 pieces</p> <p><b>CARRYING CASE C1005</b> For PW3360/3365 series, for storing options</p> <p><b>MAGNETIC STRAP Z5004</b></p>	<p>PC peripherals</p> <p><b>POWER LOGGER VIEWER SF1001</b> Easy graphical processing of measurement data saved with the PW3360/3365 series, 3169 series on a PC</p> <p><b>GENNECT One SF4000</b> Application for Windows</p> <p><b>LAN CABLE 9642</b> Straight Ethernet cable, supplied with straight to cross conversion adapter, 5 m (16.41 ft) length</p>

### Shared optional current sensors for PW3360, PW3365, and the 3169 (also available for old products the 3197, and the 3196)

For power or load current measurement (1 sensor necessary for single-phase measurements, and 2 or 3 sensors required for 3-phase measurements)

<p><b>CLAMP ON SENSOR 9694</b> 5A AC rated current, <math>\phi</math> 15 mm (0.59 in) core dia., 3 m (9.84 ft) length</p>	<p><b>CLAMP ON SENSOR 9660</b> 100A AC rated current, <math>\phi</math> 15 mm (0.59 in) core dia., 3 m (9.84 ft) length</p>	<p><b>CLAMP ON SENSOR 9661</b> 500A AC rated current, <math>\phi</math> 46 mm (1.81 in) core dia., 3 m (9.84 ft) length</p>	<p><b>FLEXIBLE CLAMP ON SENSOR CT9667-01/-02/-03</b> 5000/500 A AC rated current, <math>\phi</math> 100 mm (3.94 in) to 254 mm (10.0 in) core dia., Cable length: Between sensor - box 2 m (6.56 ft), Output cable 1 m (3.28 ft)</p>	<p><b>CLAMP ON SENSOR 9669</b> 1000A AC rated current, <math>\phi</math> 55 mm (2.17 in) core dia., 3 m (9.84 ft) length</p>	<p><b>CLAMP ON SENSOR 9695-02</b> 50A AC rated current, <math>\phi</math> 15 mm (0.59 in) core dia., Requires the Connection cord 9219</p>	<p><b>CLAMP ON SENSOR 9695-03</b> 100A AC rated current, <math>\phi</math> 15 mm (0.59 in) core dia., Requires the Connection cord 9219</p>	<p><b>CONNECTION CORD 9219</b> Connect with the 9695-02/-03, Output BNC terminal</p>
<p><b>Shared options for PW3360, PW3365, and the 3197</b> For leak current measurement (not capable of power measurement) *Up to 5 A when using with power meters</p>							
<p><b>CLAMP ON LEAK SENSOR 9675</b> 10A AC rated current, <math>\phi</math> 30 mm (1.18 in) core dia., 3 m (9.84 ft) length</p>	<p><b>CLAMP ON LEAK SENSOR 9675-10</b> 10A AC rated current, <math>\phi</math> 40 mm (1.57 in) core dia., 3 m (9.84 ft) length</p>	<p><b>Clamp sensor adapter</b> <b>CLAMP ON ADAPTER 9290-10</b> CT for 1000A AC, secondary current 1/10 of primary</p>					



# Clamp-on Power Meters

## Quickly Check Current, Voltage, Power, and Power Factor

### AC CLAMP POWER METER CM3286-50



**New**

- Display four parameters simultaneously
- A handheld power meter that measures from 5 W of power and 60 mA of current
- Measure power ranging from 5 W at a low current of 60 mA to 360 kW
- In addition to current, voltage, and power, measure simple integral power consumption and phase sequence
- Features and functions deliver fast and efficient testing
- Easily transfer measurement data to your smartphone or tablet by using our free app GENNECT Cross or to an Excel® file (Wireless Adapter Z3210 is necessary)
- Harmonic analysis from 1st to 30th order with GENNECT Cross (Wireless Adapter Z3210 is necessary)

CE  
CAT IV 600 V  
CAT III 1000 V

True RMS

3 Year Warranty

Bluetooth

When Z3210 is installed

Model No. (Order Code) **CM3286-50** (Wireless Adapter Z3210 not included)  
**CM3286-90** (Bundled with the Wireless Adapter Z3210)

#### ■ Basic specifications (Accuracy guaranteed for 1 year)

Measurement line	Single-phase, Three-phase (balanced with no distortion)
Measurement items	Voltage, Current, Voltage/ current peak, Active/ reactive/ apparent power, Power factor, Phase angle *1, Frequency, Simple Active Energy Consumption (Single-phase) [With Z3210 installed (*2)] Voltage/ current harmonics
AC voltage range	[Measurement range] 80.0 V to 600.0 V, Single range, Basic accuracy 45 - 66 Hz: $\pm 0.7\%$ rdg $\pm 3$ dgt (Frequency characteristics: 45 - 1 kHz, True RMS)
AC current range	[Measurement range] 0.060 A to 600.0 A, 3 range, Basic accuracy: $\pm 1.3\%$ rdg $\pm 3$ dgt (Frequency characteristics: 45 - 1 kHz, True RMS)
Power range	[Single phase] 0.005 kW to 360.0 kW Basic accuracy: $\pm 2.0\%$ rdg $\pm 7$ dgt (50/ 60 Hz, Power factor=1) [Balanced three-phase 3-wire] 0.020 kW to 623.5 kW Basic accuracy: $\pm 3.0\%$ rdg $\pm 10$ dgt (50/ 60 Hz, Power factor=1) [Balanced three-phase 4-wire] 0.040 kW to 1080 kW Basic accuracy: $\pm 2.0\%$ rdg $\pm 3$ dgt (50/ 60 Hz, Power factor=1)
Harmonic levels	[With Z3210 installed (*2)] Voltage/ current harmonic levels up to 30th, Content factor, Total harmonic distortion ratio
Other functions	[Phase angle (*1)] lead -180.0° to lag 179.9°, [Power factor] -1.000 to 1.000 [Frequency] 45.0 Hz to 999.9 Hz, PEAK, Phase detection, Max / Min / Avg value display, Auto hold, electric meter comparison, unbalanced 3-phase power estimate display, etc.
Dustproof and waterproof	IP50 (for measurement of current in insulated conductors or storage in completely dry conditions)
Power supply	LR03 Alkaline battery $\times 2$ , Continuous use: approx. 25 hr (without Z3210 installed), approx. 18 hr. (with Z3210 installed and using wireless communications) Other conditions: 100 A AC measurement, backlight off, 23°C reference value
Core jaw dia.	$\phi$ 46 mm (1.81 in), Jaw dimensions: 92 mm (3.62 in) W $\times$ 18 mm (0.71 in) D mm
Dimensions and mass	65 mm (2.56in) W $\times$ 241 mm (9.49in) H $\times$ 35 mm (1.38in) D, 450 g (15.9 oz)
Included accessories	Connection Cord L9257 $\times 1$ , LR03 Alkaline battery $\times 2$ , Carrying Case C0203 $\times 2$ , Instruction Manual $\times 2$ , Operating Precautions $\times 1$

\*1) Phase angle obtained from zero cross of current / voltage.  
\*2) Harmonics can be displayed with our free app GENNECT Cross.

**Bundled Accessories**

**CONNECTION CORD L9257**  
L4930, L4935 bundled model, 1.2 m (3.94 ft) length

**CARRYING CASE C0203**

**Test lead**

**TEST LEAD L9207-10**  
90 cm (2.95 ft) length

**TEST LEAD L9300**  
95 cm (37.4 in.), Integrated cap and protective finger guard

**Clamp adapter**

**CLAMP ON ADAPTER 9290-10**  
CT for 1000A AC, secondary current 1/10 of primary

Options for the L4930. Test Pin Set L4932 is required when using the Small Alligator Clip Set L4934

<b>CONNECTION CABLE SET L4930</b> 1.2 m (3.94 ft) length, CAT IV 600V, CAT III 1000V	<b>EXTENSION CABLE SET L4931</b> Expands the length of the L4930/L4940, 1.5 m (4.92 ft) length	<b>TEST PIN SET L4932</b> Attaches to the tip of the L4930/L4940, CAT IV 600V, CAT III 1000V	<b>SMALL ALLIGATOR CLIP SET L4934</b> Attaches to the tip of the L9207-10/DT4911, L9206, CAT III 300V, CAT II 600V	<b>ALLIGATOR CLIP SET L4935</b> Attaches to the tip of the L4930/L4940, CAT IV 600V, CAT III 1000V	<b>BUS BAR CLIP SET L4936</b> Attaches to the tip of the L4930/L4940, CAT III 600V	<b>MAGNETIC ADAPTER SET L4937</b> Attaches to the tip of the L4930/L4940, CAT III 1000V	<b>MAGNETIC ADAPTER 9804</b> Attaches to the tip of voltage cord, $\phi$ 1 mm (0.43 in), compatible M6 pan screws	<b>TEST PIN SET L4938</b> Attaches to the tip of the L4930/L4940, CAT III 600V	<b>BREAKER PIN SET L4939</b> Attaches to the tip of the L4930/L4940, CAT III 600V	<b>GRABBER CLIP L9243</b> Attaches to the tip of the L4930/L4940, CAT II 1000 V, 185 mm (7.28 in) length
---	---	---	---	---	---	--	--	---	--	---

**wireless communication**

Bundled accessory for the CM3286-90.

**WIRELESS ADAPTER Z3210**  
Simply plug in the Z3210 wireless adapter and your compatible HIOKI device is Bluetooth® ready

**PC peripherals**

When using Z3210.

**GENNECT Cross SF4071, SF4072**  
Mobile app for iOS, Android

## Capture Inrush, Micro and High-Speed Currents with a Single Probe

### CURRENT PROBE CT6710, CT6711



CT6710

- 3 ranges in a single probe - 30 A, 5 A, 0.5 A. Observe a wide current range from micro currents to 30 A.
- Wide band: [CT6710] DC to 50 MHz (-3 dB), [CT6711] DC to 120 MHz (-3 dB)
- High S/N ratio and 10 times output rate: Observe waveforms at 100  $\mu$ A/div at oscilloscope maximum voltage sensitivity setting of 1 mV/div
- Directly connect to an oscilloscope's BNC input terminal \*1

\*1: Connecting the probe's metal BNC terminal to a Memory HiCorder's plastic BNC terminal may distort or damage the plastic terminal. To avoid damage, please connect and disconnect the probe cable straight to the BNC terminal of the waveform monitoring equipment.

Model No. (Order Code)	<b>CT6710</b>	(From 200 $\mu$ A, 50MHz bandwidth)
	<b>CT6711</b>	(From 200 $\mu$ A, 120MHz bandwidth)

Note: If power cannot be supplied from the Memory HiCorder, an optional power supply 3269 is required. Please pay attention to offset drift during continuous, long-term measurement.

#### ■ (Typical characteristics example)

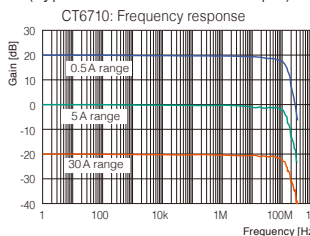

#### ■ (Typical characteristics example)

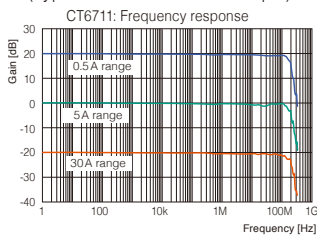

#### ■ Basic specifications (Accuracy guaranteed for 1 year)

	CT6710	CT6711
Frequency bandwidth	DC to 50 MHz (-3 dB)	DC to 120 MHz (-3 dB)
Rise time	7.0 ns or shorter	2.9 ns or shorter
Delay time (Typical)	30 A range: 12 ns, 5 A range: 12 ns, 0.5 A range: 13 ns (Delay time relative to rising waveform of input signal 1 ns)	
Noise level	75 $\mu$ A rms max (at 0.5 A range, using 20 MHz band measuring instrument)	
Max. rated current	30 A range: 30 A rms, 5 A range: 5 A rms, 0.5 A range: 0.5 A rms (DC, and sine wave, requires derating at frequency)	
Max. allowable peak current	30 A range: $\pm$ 50 A peak (within the input limit time 2 s) 5 A range: $\pm$ 7.5 A peak, 0.5 A range: $\pm$ 0.75 A peak (< 10 MHz), $\pm$ 0.3 A peak ( $\geq$ 10 MHz)	
Amplitude accuracy	30 A range: $\pm$ 3.0% rdg $\pm$ 1 mV, (Typical) $\pm$ 1.0% rdg $\pm$ 1 mV ( $\leq$ 10 Arms, DC, 45 to 66 Hz sine wave, within the maximum peak current of each range) 5 A range: $\pm$ 3.0% rdg $\pm$ 1 mV, (Typical) $\pm$ 1.0% rdg $\pm$ 1 mV (DC, 45 to 66 Hz sine wave, within the maximum peak current of each range) 0.5 A range: $\pm$ 3.0% rdg $\pm$ 10 mV, (Typical) $\pm$ 1.0% rdg $\pm$ 10 mV (DC, 45 to 66 Hz sine wave, within the maximum peak current of each range)	
Output rate	30 A range: 0.1 V/A, 5 A range: 1 V/A, 0.5 A range: 10 V/A (The output of this probe is internally terminated)	
Measurable conductors	$\phi$ 5 mm (0.20 in), Insulated conductor	
Power supply	Supplied from Power Supply 3269, Probe Power Unit Z5021	
Cable length	Sensor cable (between relay box and sensor): 1.5 m (4.92 ft) Power cable: 1.0 m (3.28 ft) (Power plug: FFA.OS.304.CLAC37Y / LEMO inc.)	
Dimensions and mass	Sensor: 155 mm (6.10 in)W $\times$ 18 mm (0.71 in)H $\times$ 26 mm (1.02 in)D, Relay box section: 45 mm (1.77 in)W $\times$ 120 mm (4.72 in)H $\times$ 25 mm (0.98 in)D Terminator section: 29 mm (1.14 in)W $\times$ 83 mm (3.27 in)H $\times$ 40 mm (1.57 in)D mm, 370 g (13.1 oz)	
Included accessories	Instruction manual $\times$ 1, Carrying case $\times$ 1	

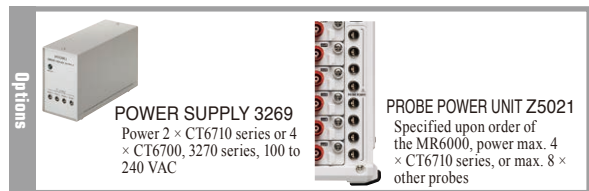

Current Probes

## Clearly Observe Even 1 mA Waveforms

### CURRENT PROBE CT6700, CT6701



CT6700

- Wide band: [CT6700] DC to 50 MHz (-3 dB), [CT6701] DC to 120 MHz (-3 dB)
- High S/N characteristic ideal for ultra low 1 mA order current waveforms
- Connect directly to an oscilloscope's BNC input terminal \*1

\*1: Connecting the probe's metal BNC terminal to a Memory HiCorder's plastic BNC terminal may distort or damage the plastic terminal. To avoid damage, please connect and disconnect the probe cable straight to the BNC terminal of the waveform monitoring equipment.

Model No. (Order Code)	<b>CT6700</b>	(From 1mA, 50MHz bandwidth)
	<b>CT6701</b>	(From 1mA, 120MHz bandwidth)

Note: Use optional Power Supply 3269 or 3272 to drive the current probe when power from the Memory HiCorder or oscilloscope is not available. Exercise care concerning offset drift when performing continuous measurement over extended periods of time.

#### ■ (Typical characteristics example)

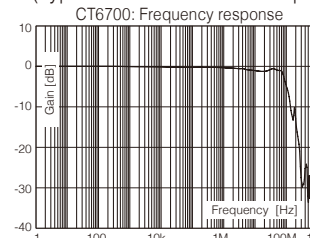

#### ■ (Typical characteristics example)

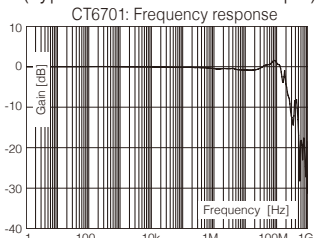

#### ■ Basic specifications (Accuracy guaranteed for 1 year)

	CT6700	CT6701
Frequency bandwidth	DC to 50 MHz (-3 dB)	DC to 120 MHz (-3 dB)
Rise time	7.0 ns or shorter	2.9 ns or shorter
Noise level	60 $\mu$ A rms typical, 75 $\mu$ A rms max (for 30 MHz band measuring instrument)	
Continuous allowable input	5 A rms (DC, and sine wave, requires derating at frequency)	
Max. allowable peak input	$\pm$ 7.5 A peak (non-continuous)	
Amplitude accuracy	Typ.: $\pm$ 1% rdg $\pm$ 1 mV (DC, 45 to 66 Hz sine wave, 0 to 5 A rms) Guaranteed: $\pm$ 3% rdg $\pm$ 1 mV (DC, 45 to 66 Hz sine wave, 0 to 5 A rms)	
Output rate	1 V/A (The output of this probe is internally terminated)	
Measurable conductors	Insulated conductor	
Core diameter	$\phi$ 5 mm (0.20 in)	
Power supply	$\pm$ 12 V $\pm$ 0.5 V, 3.2 VA	
Dimensions and mass	Sensor: 155 mm (6.10 in)W $\times$ 18 mm (0.71 in)H $\times$ 26 mm (1.02 in)D, Terminator: 29 mm (1.14 in)W $\times$ 83 mm (3.27 in)H $\times$ 40 mm (1.57 in)D mm, Mass: 250 g (8.8 oz), Sensor cable BNC terminal: 1.5 m (4.92 ft), Power cable: 1 m (3.28 ft), Power plug: FFA.OS.304.CLAC37Y / LEMO inc.	
Included accessories	Instruction manual $\times$ 1, Carrying case $\times$ 1	

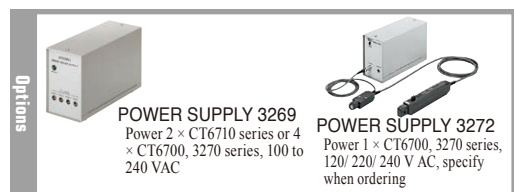

## Wide-Band Current Probe Allows Direct Input to Oscilloscope

### CLAMP ON PROBE 3273-50, 3274, 3275, 3276



- Waveform observation across a wide band from DC to MHz
- Connects directly to oscilloscope or Memory HiCorder BNC input terminal \*1
- High S/N characteristics enable the measurement of 10 mA order current waveforms (3273-50, 3276)

\*1: Connecting the probe's metal BNC terminal to a Memory HiCorder's plastic BNC terminal may distort or damage the plastic terminal. To avoid damage, please connect and disconnect the probe cable straight to the BNC terminal of the waveform monitoring equipment.

Model No. (Order Code)	<b>3273-50</b>	(DC to 50 MHz, 30 Arms)
	<b>3274</b>	(DC to 10 MHz, 150 Arms)
	<b>3275</b>	(DC to 2 MHz, 500 Arms)
	<b>3276</b>	(DC to 100 MHz, 30 Arms)

### Frequency response (Characteristics Example)

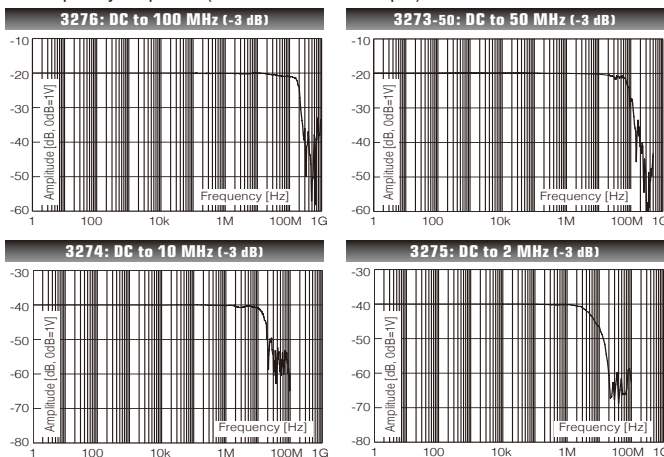

Note: Use the Power Supply 3269/3272 for general measurements or when power is not available from the Memory HiCorder. When performing continuous measurements, be aware of offset voltage drift.



### Connecting Wideband Sensors to Other Devices

Below are the options necessary for connecting wide-bandwidth sensors to measurement devices.

Current sensor model No.	POWER ANALYZER PW6001	MEMORY HiCORDER Oscilloscope
3273-50 3274 3275 CT6700 CT6701	- Direct connection possible - Power by the PW6001	- Dedicated extension cable (synthetic resin BNC or metal BNC conversion cable) is recommended - POWER SUPPLY 3269 or 3272 is required - When using a recorder, the PROBE POWER UNIT Z5021 is also available.
CT6710 CT6711	-	When using a recorder, the Probe Power Unit Z5021 supports the use of up to 4 sensors.

When using the High-speed Analog Unit U8976 (Frequency range: DC to 30MHz)



Z5021 PROBE POWER UNIT

Connect up to four CT6710/CT6711 probes.

### Basic specifications (Accuracy guaranteed for 1 year)

	3276	3273-50	3274	3275
Frequency bandwidth	DC to 100 MHz (-3 dB)	DC to 50 MHz (-3 dB)	DC to 10 MHz (-3 dB)	DC to 2 MHz (-3 dB)
Rise time	3.5 ns or shorter	7 ns or shorter	35 ns or shorter	175 ns or shorter
Noise level	2.5 mA rms max. (bandwidth limited to 20 MHz)			
Continuous allowable input	30 A rms (requires derating at frequency)		150 A rms (requires derating at frequency)	500 A rms (requires derating at frequency)
Max. allowable peak input	50 A peak (non continuous)		300 A peak (non continuous) 500 A peak (pulse width: 30 μs or shorter)	700 A peak (non continuous)
Amplitude accuracy (30 min. after power-on, after degaussing and zero-adjustment)	±1.0 % rdg ±1 mV f.s. (DC, 45 to 66 Hz, 0 to 30 A rms) ±2 % rdg (DC, 45 to 66 Hz, 30 A rms to 50 A peak)		±1.0 % rdg ±1 mV f.s. (DC, 45 to 66 Hz, 0 to 150 A rms) ±2.0 % rdg (DC, 45 to 66 Hz, 150 A to 300 A peak)	±1.0 % rdg ±5 mV f.s. (DC, 45 to 66 Hz, 0 to 500 A rms) ±2.0 % rdg (DC, 45 to 66 Hz, 500 A to 700 A peak)
Output rate	0.1 V/A (The output of this probe is internally terminated)		0.01 V/A (The output of this probe is internally terminated)	
Measurable conductors	Insulated conductor		Insulated conductor	
Core diameter	φ 5 mm (0.20 in)		φ 20 mm (0.79 in)	
Power supply	±12 V ±0.5 V, 5.3 VA max.	±12 V ±0.5 V, 5.6 VA max.	±12 V ±1 V, 5.5 VA max.	±12 V ±0.5 V, 7.2 VA max.
Dimensions and mass	175 mm (6.89 in)W × 18 mm (0.71 in)H × 40 mm (1.57 in)D, 240 g (8.5 oz)	175 mm (6.89 in)W × 18 mm (0.71 in)H × 40 mm (1.57 in)D, 230 g (8.1 oz)	176 mm (6.93 in)W × 69 mm (2.72 in)H × 27 mm (1.06 in)D, 500 g (17.6 oz)	176 mm (6.93 in)W × 69 mm (2.72 in)H × 27 mm (1.06 in)D, 520 g (18.3 oz)
Included accessories	Instruction manual ×1, Carrying case ×1	Instruction manual ×1, Soft case ×1	Instruction manual ×1, Carrying case ×1	Instruction manual ×1, Carrying case ×1

## Power Supply for Current Probes

### POWER SUPPLY 3269, 3272



Combination example of the 3272 + Clamp-on probe

- Power supply for the Clamp on probe 3273-50 - 3276, CT6700 series
- Supplies power when connected to a general-purpose instrument such as a recorder.

Model No. (Order Code)	<b>3269</b>	(For the CT6700s/3270s, up to 4)
	<b>3272</b>	(For the CT6700s/3270s, up to 1 or 2)

Note: These products cannot be used alone. To measure current, a compatible current sensor is required.

### Basic specifications

	3269	3272
Compatible sensors	The CT6710, CT6711: up to 2 units The CT6700, CT6701, 3273-50, 3274, 3275 or 3276: up to 4 units Note: Also up to 4 units for the discontinued Model 3273	The CT6700, CT6701: up to 2 units Note: When measuring the maximum peak current, only one unit The 3273-50, 3274, 3275 or 3276: up to 1 unit Note: May be used with up to 2 units of Model 3273 (not -50 type), and up to 2 units of Models 3273-50, 3274, 3275 or 3276 on condition that the measurement current is sufficiently low. Note: The CT6710, CT6711 cannot be used
Number of power supply connectors	4	2
Output	±12 V ±0.5 V, ±2.5 A (sum total of all channels)	±12 V ±0.5 V, 600 mA (sum total of all channels)
Power supply	100 V to 240 V AC (free) 50/60 Hz 170 VA max.	100 V or 120/220/240 V AC (specify when ordering), 50/60 Hz 20 VA max.
Dimensions and mass	80 mm (3.15 in)W × 119 mm (4.69 in)H × 200 mm (7.87 in)D, 1.1 kg (38.8 oz)	73 mm (2.87 in)W × 110 mm (4.33 in)H × 186 mm (7.32 in)D, 1.1 kg (38.8 oz)
Included accessories	Instruction manual ×1, Power cord ×1	Power cord ×1, Instruction manual ×1, Spare fuse ×1

## Best-in-class Measurement Bandwidth with High Accuracy

### AC/DC CURRENT SENSOR CT6904A



Please contact your HIOKI distributor or subsidiary for more information.  
**Other options**  
 • Metal fittings

- Combined accuracy with HIOKI power analyzer PW8001 and PW6001 is specified (DC, 45 Hz ≤ f ≤ 65 Hz). For details of combined accuracy, refer to the instruction manual.
- 500 A (rms) or 800A (rms) rated for measurement of large currents
- Wide measurement frequency range: DC to 4 MHz (CT6904A, CT9604A-2)
- ±5 ppm excellent linearity (CT6904A, CT6904A-1)
- 120 dB (100 kHz) high Common-Mode Rejection Ratio (CMRR)

Model No. (Order Code)

<b>CT6904A</b>	(500 A AC/DC, HIOKI ME15A terminal, cable length: 3 m [9.84 ft.])
<b>CT6904A-1</b>	(Build-to-order, 500 A AC/DC, HIOKI ME15A terminal, cable length: 10 m [32.81 ft.])
<b>CT6904A-2</b>	(Build-to-order, 800 A AC/DC, HIOKI ME15A terminal, cable length: 3 m [9.84 ft.])
<b>CT6904A-3</b>	(Build-to-order, 800 A AC/DC, HIOKI ME15A terminal, cable length: 10 m [32.81 ft.])

#### Basic specifications (Accuracy guaranteed for 1 year)

	CT6904A, CT6904A-1	CT6904A-2, CT6904A-3
Rated current	500 A AC/DC	800 A AC/DC
Max. allowable input	±1000 A peak	±1200 A peak
	Within the derating range, design value, within 20 ms and 40°C (104°F) or less	
Frequency characteristics	Amplitude: DC to 4 MHz (CT6904A-1, CT6904A-3); DC to 2 MHz (Phase: DC to 1 MHz)	
Linearity	±5 ppm Typical (23°C [73°F])	±12.5 ppm Typical (23°C [73°F])
Offset voltage	±10 ppm Typical (23°C (73°F), no input)	
Basic accuracy	DC (Amplitude: ±0.025 % rdg. ±0.007 % f.s., no phase specification) 45 Hz ≤ f ≤ 65 Hz (Amplitude: ±0.02 % rdg. ±0.007 % f.s., Phase: ±0.08°)	DC (Amplitude: ±0.030 % rdg. ±0.009 % f.s., no phase specification) 45 Hz ≤ f ≤ 65 Hz (Amplitude: ±0.025 % rdg. ±0.007 % f.s., Phase: ±0.08°)
	Defined to 1 MHz	
Output voltage rate	4 mV / A rated	2 mV / A rated
	This device outputs AC+DC voltage via the Sensor Unit	
Max. rated voltage to earth	1000 V CAT III	
Core diameter	φ 32 mm (1.26 in)	
Operating temperature, humidity	-10°C to 50°C (14°F to 122°F) 80% RH or less (with no condensation)	
Power supply	Power supplied via the Power Analyzer PW8001, PW6001, PW3390, or Sensor Unit CT9555, CT9556, CT9557	
Max. rated power	7 VA Max. (500 A/55 Hz measurement, with a power supply of ±12 V)	
Dimensions and mass	139 mm (5.47 in)W × 120 mm (4.72 in)H × 52 mm (2.05 in)D CT6904A: 1.05 kg (37 oz), cable length 3 m (9.84 ft) CT6904A-1: 1.35 kg (47.6 oz), cable length 10 m (32.81 ft)	CT6904A-2: 1.15 kg (40.6 oz), cable length 3 m (9.84 ft) CT6904A-3: 1.45 kg (51.1 oz), cable length 10 m (32.81 ft)
Included accessories	Instruction manual ×1, Carrying case ×1, Color labels (for channel identification) ×1	

## Supports Current Measurement of Inverters with High Current and High Speed

### AC/DC CURRENT SENSOR CT6875A, CT6876A, CT6877A



HIOKI ME15W (12-pin terminal)

- Combined accuracy with HIOKI power analyzer PW8001, PW6001 and PW3390 is specified (DC, 45 Hz ≤ f ≤ 66 Hz). For details of combined accuracy, refer to the instruction manual.
- Meet a wide range of applications from measuring battery charge/discharge to the secondary side of inverters in photovoltaic power generation and fuel cell evaluation, etc.
- Monitor waveforms when paired with oscilloscopes or Memory HiCorders and Sensor Unit
- Measures high-current up to 2000 A for EV, HEV and other electric vehicles (CT6877A)
- Improved noise resistance performance through a stronger shield lets you accurately measure current buried in noise
- High accuracy measurement realized through flat frequency characteristics and CMRR performance
- More enhanced environmental resistance performance than ever before lets you measure in -40 to 85°C situations
- Superior frequency characteristics  
 CT6875A: DC to 2 MHz (amplitude), CT6876A: DC to 1.5 MHz (amplitude), CT6877A: DC to 1 MHz (amplitude)

Model No. (Order Code)	CT6875A	CT6875A-1	CT6876A	CT6876A-1	CT6877A	CT6877A-1
	(500 A AC/DC, ME15W terminal, 3 m (9.84 ft) cable length)	(500 A AC/DC, ME15W terminal, 10 m (32.81 ft) cable length)	(1000 A AC/DC, ME15W terminal, 3 m (9.84 ft) cable length)	(1000 A AC/DC, ME15W terminal, 10 m (32.81 ft) cable length)	(2000 A AC/DC, ME15W terminal, 3 m (9.84 ft) cable length)	(2000 A AC/DC, ME15W terminal, 10 m (32.81 ft) cable length)

Compatible models	CT6875A	CT6876A	CT6877A
PW8001	✓	✓	✓
PW6001	✓	✓	✓
PW3390	✓	✓	✓
U8977	✓	✓	✓
8971	▲ (Requires the 9318, CT9901)	▲ (Requires the 9318, CT9901)	N/A

#### Shared options for CT6904A, CT6875A, CT6876A and CT6877A

**Option A**

**SENSOR UNIT CT9555**  
Power supply for current sensors (1ch, with waveform output)

**SENSOR UNIT CT9556**  
Power supply for current sensors (1ch, with waveform/RMS output)

**SENSOR UNIT CT9557**  
Power supply for current sensors (4ch, with waveform/total waveform/total RMS output)

**CONNECTION CORD L9217**  
Cord has insulated BNC connectors at both ends, 1.6 m (5.25 ft) length

**CONNECTION CORD 9165**  
Cord has metallic BNC connectors at both ends, use at metallic terminal, 1.5 m (4.92 ft) length

The CT9902 connects up to 2 cables in series

**Option B**

**CONVERSION CABLE CT9901**  
HIOKI ME15W (12 pin) to HIOKI PL23 (10 pin) connector

**EXTENSION CABLE CT9902**  
5 m (16.41 ft) length, HIOKI ME15W (12 pin) - HIOKI ME15W (12 pin) connector

For connecting to the FV Unit 8940 or Current Unit 8971

**Option D**

**CONVERSION CABLE 9318**  
To connect HIOKI PL23 (10 pin) connector to the 8971/40/51, 38 cm (14.96 in) length

#### Basic specifications (Accuracy guaranteed for 1 year)

	CT6875A, CT6875A-1	CT6876A, CT6876A-1
Rated current	500 A AC/DC	1000 A AC/DC
Max. allowable input	Within the derating range, up to ±1500 A peak (design value) allowed at 40°C or less for 20 ms or less	Within the derating range, up to ±1800 A peak (design value) allowed at 40°C or less for 20 ms or less
Frequency bandwidth	Amplitude: DC to 2 MHz (CT6875A), DC to 1.5 MHz (CT6875A-1) Phase: DC to 1 MHz	Amplitude: DC to 1.5 MHz (CT6876A), DC to 1.2 MHz (CT6876A-1) Phase: DC to 1 MHz
Basic accuracy	(DC, 45 Hz ≤ f ≤ 66 Hz) Amplitude: ±0.04 % rdg ±0.008 % f.s., Phase: ±0.1°	(DC, 45 Hz ≤ f ≤ 66 Hz) Amplitude: ±0.04 % rdg ±0.008 % f.s., Phase: ±0.1°
Output voltage rate	4 mV / A rated	2 mV / A rated
	This device outputs AC+DC voltage via the Sensor Unit.	
Max. rated voltage to earth	1000 V AC/DC (50/60 Hz, CAT III)	
Core diameter	φ 36 mm (1.42 in)	
Operating temperature, humidity	-40°C to +85°C (-40°F to 185°F), 80% RH or less (with no condensation)	
Power supply	Power supplied via the Power Analyzer PW8001, PW6001, PW3390, Sensor Unit CT9555, CT9556, CT9557, or 3CH CURRENT UNIT U8977	
Max. rated power	7 VA max. (at 500 A/55 Hz)	7.5 VA max. (at 1000 A/55 Hz)
Dimensions and mass	160 mm (6.30 in)W × 112 mm (4.41 in)H × 50 mm (1.97 in)D, CT6875A: 850 g (30 oz), cable length 3 m (9.84 ft), CT6875A-1: 1150 g (40.6 oz), cable length 10 m (32.81 ft)	160 mm (6.30 in)W × 112 mm (4.41 in)H × 50 mm (1.97 in)D, CT6876A: 970 g (34.2 oz), cable length 3 m (9.84 ft), CT6876A-1: 1300 g (45.9 oz), cable length 10 m (32.81 ft)
Included accessories	Instruction manual ×1, Mark bands ×6, Operating precautions ×1	
	CT6877A, CT6877A-1	
Rated current	2000 A AC/DC	
Max. allowable input	Within the derating range, (within the specified range up to ±3200 A peak)	
Frequency characteristics	Amplitude: DC to 1 MHz, Phase: DC to 700 kHz	
Linearity	±10 ppm Typical (23°C [73°F])	
Offset voltage	±5 ppm Typical (23°C (73°F), no input)	
Basic accuracy	(DC, 45 Hz ≤ f ≤ 66 Hz) Amplitude: ±0.04 % rdg ±0.008 % f.s., Phase: ±0.08°	
Output voltage rate	1 mV / A rated (This device outputs AC+DC voltage via the Sensor Unit.)	
Max. rated voltage to earth	1000 V AC/DC (50/60 Hz, CAT III)	
Core diameter	φ 80 mm (3.15 in)	
Operating temperature, humidity	-40°C to +85°C (-40°F to 185°F), 80% RH or less (with no condensation)	
Power supply	Power supplied via the Power Analyzer PW8001, PW6001, PW3390, Sensor Unit CT9555, CT9556, CT9557, or 3CH CURRENT UNIT U8977	
Max. rated power	9.5 VA max. (at 2000 A/55 Hz, ±12 V power requirement)	
Dimensions and mass	229 mm (9.02 in)W × 232 mm (9.13 in)H × 112 mm (4.41 in)D, CT6877A: 5 kg (176.4 oz), cable length 3 m (9.84 ft), CT6877A-1: 5.3 kg (186.9 oz), cable length 10 m (32.81 ft)	
Included accessories	Instruction manual ×1, Mark bands ×6, Operating precautions ×1	

## Low-current Model of 50 A or 200A rating, with Wideband and High Accuracy

### AC/DC CURRENT SENSOR CT6872, CT6873



- Combined accuracy with HIOKI power analyzer PW8001, PW6001 and PW3390 is specified (DC, 45 Hz ≤ f ≤ 66 Hz). For details of combined accuracy, refer to the instruction manual.
- Wide-bandwidth DC to 10 MHz excellent frequency characteristics
- Applications in the fields of electric and hybrid electric vehicles
- Wide operating temperature range(-40°C to 85°C) fit for automobile applications
- Ideal for evaluation of solar power generation and fuel cells to measure battery charge and discharge and the secondary side of inverters
- For observing waveforms to be used with the oscilloscopes or Memory HiCorders (use with Sensor Unit)

Model No. (Order Code)	CT6872	CT6872-01	CT6873	CT6873-01
	(50 A AC/DC, ME15W terminal, 3 m (9.84 ft) cable length)	(50 A AC/DC, ME15W terminal, 10 m (32.81 ft) cable length)	(200 A AC/DC, ME15W terminal, 3 m (9.84 ft) cable length)	(200 A AC/DC, ME15W terminal, 10 m (32.81 ft) cable length)

Note: These products cannot be used alone. The optional SENSOR UNIT is required in order to supply power and connect the clamp to a Memory HiCorder or other instrument. Products can be directly connected to the compatible Power Meters.

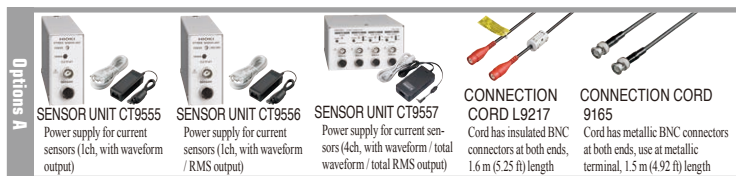

#### Basic specifications (Accuracy guaranteed for 1 year)

	CT6872, CT6872-01	CT6873, CT6873-01
Rated current	500 A AC/DC	1000 A AC/DC
Max. allowable input	Within the derating range, up to ±1500 Apeak (design value) allowed at 40°C or less for 20 ms or less	Within the derating range, up to ±1800 Apeak (design value) allowed at 40°C or less for 20 ms or less
Frequency bandwidth	Amplitude: DC to 2 MHz (CT6875A), DC to 1.5 MHz (CT6875A-1) Phase: DC to 1 MHz	Amplitude: DC to 1.5 MHz (CT6876A), DC to 1.2 MHz (CT6876A-1) Phase: DC to 1 MHz
Basic accuracy	(DC, 45 Hz ≤ f ≤ 66 Hz) Amplitude: ±0.04 % rdg ±0.008 % f.s., Phase: ±0.1°	(DC, 45 Hz ≤ f ≤ 66 Hz) Amplitude: ±0.04 % rdg ±0.008 % f.s., Phase: ±0.1°
Output voltage rate	4 mV / A rated	2 mV / A rated
	This device outputs AC+DC voltage via the Sensor Unit.	
Max. rated voltage to earth	1000 V AC/DC (50/60 Hz, CAT III)	
Core diameter	φ 36 mm (1.42 in)	
Operating temperature, humidity	-40°C to +85°C (-40°F to 185°F), 80% RH or less (with no condensation)	
Power supply	Power supplied via the Power Analyzer PW8001, PW6001, PW3390, Sensor Unit CT9555, CT9556, CT9557, or 3CH CURRENT UNIT U8977	
Max. rated power	7 VA max. (at 500 A/55 Hz)	7.5 VA max. (at 1000 A/55 Hz)
Dimensions and mass	160 mm (6.30 in)W × 112 mm (4.41 in)H × 50 mm (1.97 in)D, CT6875A: 800 g (28.2 oz), cable length 3 m (9.84 ft), CT6875A-1: 1100 g (38.8 oz), cable length 10 m (32.81 ft)	160 mm (6.30 in)W × 112 mm (4.41 in)H × 50 mm (1.97 in)D, CT6876A: 950 g (33.5 oz), cable length 3 m (9.84 ft), CT6876A-1: 1250 g (44.1 oz), cable length 10 m (32.81 ft)
Included accessories	Instruction manual ×1, Mark bands ×6, Operating precautions ×1	

Compatible models	CT6872	CT6873
Power Analyzer PW8001	✓	✓
Power Analyzer PW6001	✓	✓
Power Analyzer PW3390	✓	✓
3CH Current Unit U8977	✓	✓
Current Unit 8971	▲ (Requires the 9318, CT9901)	▲ (Requires the 9318, CT9901)

## Delivering Wide Operating Temperature Range and High-precision Current Measurement

### AC/DC CURRENT SENSOR CT6862, CT6863



- Super high precision
- Wide-bandwidth DC to 1 MHz (CT6862-05) excellent frequency characteristics
- Applications in the fields of electric and hybrid electric vehicles
- Wide operating temperature range(-30 °C to 85 °C) fit for automobile applications
- Ideal for evaluation of solar power generation and fuel cells to measure battery charge and discharge and the secondary side of inverters
- For observing waveforms to be used with the oscilloscopes or Memory HiCorders (use with SENSOR UNIT)

Model No. (Order Code)	CT6862-05	CT6863-05
	(50 A AC/DC, ME15W terminal)	(200 A AC/DC, ME15W terminal)

Note: These products cannot be used alone. The optional SENSOR UNIT is required in order to supply power and connect the clamp to a Memory HiCorder or other instrument. Products can be directly connected to the compatible Power Meters.

#### Basic specifications (Accuracy guaranteed for 1 year)

	CT6862-05	CT6863-05
Rated current	50 A AC/DC	200 A AC/DC
Max. allowable input	100 A rms (requires derating)	400 A rms (requires derating)
Frequency characteristics	Amplitude: DC to 1 MHz Phase: DC to 300 kHz	Amplitude: DC to 500 kHz Phase: DC to 300 kHz
Amplitude and Phase accuracy	DC ±0.05 % rdg ±0.01 % f.s. (Phase: Not defined) 16 Hz ≤ f ≤ 400 Hz ±0.05 % rdg ±0.01 % f.s. (Phase: ±0.2°) Defined to 1 MHz (CT6862-05) Defined to 500 kHz (CT6863-05)	
Output voltage	2 V / rated current value (This device outputs AC+DC voltage via the Sensor Unit.)	
Max. rated voltage to earth	1000 V AC/DC (50/60 Hz, CAT III)	
Core diameter	φ 24 mm (0.94 in)	
Operating temperature, humidity	-30°C to +85°C (-22°F to 185°F), 80% RH or less (with no condensation)	
Power supply	Power supplied via the Power Analyzer PW8001, PW6001, PW3390, or Sensor Unit CT9555, CT9556, CT9557, or 3CH CURRENT UNIT U8977	
Power consumption	5 VA max. (at 50 A/55 Hz, ±12 V power requirement)	6 VA max. (at 200 A/55 Hz, ±12 V power requirement)
Dimensions and mass	70 mm (2.76 in)W × 100 mm (3.94 in)H × 53 mm (2.09 in)D, 340 g (12.0 oz), cord length: 3 m (9.84 ft)	70 mm (2.76 in)W × 100 mm (3.94 in)H × 53 mm (2.09 in)D, 350 g (12.3 oz), cord length: 3 m (9.84 ft)
Included accessories	Instruction manual ×1, Mark bands ×6	

Compatible models	(CT6862)	CT6862-05	(CT6863)	CT6863-05
PW8001	▲ (Requires the CT9900)	✓	▲ (Requires the CT9900)	✓
PW6001	▲ (Requires the CT9900)	✓	▲ (Requires the CT9900)	✓
PW3390	▲ (Requires the CT9900)	✓	▲ (Requires the CT9900)	✓
U8977	▲ (Requires the CT9900)	✓	▲ (Requires the CT9900)	✓
8971	▲ (Requires the 9318)	▲ (Requires the 9318, CT9901)	▲ (Requires the 9318)	▲ (Requires the 9318, CT9901)

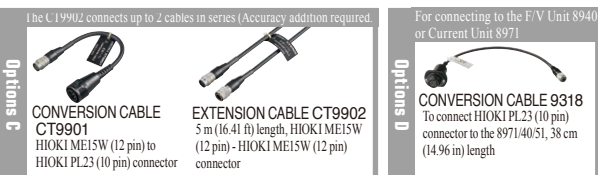

## High-precision Current Testing

### AC/DC CURRENT PROBE CT6844A, CT6845A, CT6846A



- Combined accuracy with HIOKI power analyzer PW8001, PW6001 and PW3390 is specified (DC, 45 Hz  $\leq$  f  $\leq$  66 Hz). For details of combined accuracy, refer to the instruction manual.
- Frequency bandwidth: DC to 500 kHz (CT6844A), DC to 200 kHz (CT6845A), DC to 100 kHz (CT6846A)
- Ideal for use in environmental testing with broad -40°C to 85°C temperature range
- Single-handed operation and robust locking mechanism
- Large jaw for clamping thick and paired wires (CT6845A, CT6846A)
- Power supplied via the measurement instrument (when connecting HIOKI POWER ANALYZER or MEMORY HiCORDER)
- Ideal for EV inverter evaluation and PV power generation PCS evaluation

Model No. (Order Code)	<b>CT6844A</b>	(500 A AC/DC, ME15W terminal)
	<b>CT6845A</b>	(500 A AC/DC, ME15W terminal)
	<b>CT6846A</b>	(1000 A AC/DC, ME15W terminal)

Compatible models	CT6844A	CT6845A	CT6846A
PW8001	✓	✓	✓
PW6001	✓	✓	✓
PW3390	✓	✓	✓
U8977	✓	✓	✓
8971	▲ (Requires the 9318, CT9901)	▲ (Requires the 9318, CT9901)	▲ (Requires the 9318, CT9901)

#### Basic specifications (Accuracy guaranteed for 1 year)

	CT6844A	CT6845A	CT6846A
Rated current	500 A AC/DC		1000 A AC/DC
Frequency characteristics	DC to 500 kHz	DC to 200 kHz	DC to 100 kHz
Core diameter	$\phi$ 20 mm (0.79 in)		
Max. allowable input	$\pm$ 800 Apeak (Within 20 ms in an environment of 40°C/104°F or less)	$\pm$ 1500 Apeak (Within 20 ms in an environment of 40°C/104°F or less)	$\pm$ 1900 Apeak (Within 20 ms in an environment of 40°C/104°F or less)
Output voltage	4 mV/A		2 mV/A
Output resistance	50 $\Omega$ $\pm$ 10 $\Omega$		
Accuracy (amplitude)	DC: $\pm$ 0.2 % rdg +0.02 % f.s., DC < f $\leq$ 100 Hz $\pm$ 0.2 % rdg $\pm$ 0.01 % f.s.		
Linearity	$\pm$ 20 ppm Typical		
Common-Mode Voltage Rejection Ratio (CMRR)	DC to 1 kHz: 150 dB or greater 1 kHz to 10 kHz: 135 dB or greater 10 kHz to 100 kHz: 120 dB or greater 100 kHz to 300 kHz: 100 dB or greater (effect on output voltage and common mode voltage)	DC to 1 kHz: 150 dB or greater 1 kHz to 10 kHz: 130 dB or greater 10 kHz to 100 kHz: 100 dB or greater (effect on output voltage and common mode voltage)	DC to 1 kHz: 150 dB or greater 1 kHz to 10 kHz: 130 dB or greater 10 kHz to 50 kHz: 100 dB or greater (effect on output voltage and common mode voltage)
Automatic phase correction	Automatically performs phase correction when connected to PW8001		
Operating temperature, humidity	-40 °C to +85 °C (-40 °F to 185 °F), 80% RH or less (with no condensation)		
Standards	Safety IEC 61010-2-032:2012/EN 61010-2-032:2012 Type D EMC IEC 61326-1:2012/EN 61326-1:2013		
Withstand voltage	AC 4,260 V		
Power supply	Power supplied via the Power Analyzer PW8001, PW6001, PW3390, Sensor Unit CT9555, CT9556, CT9557, or 3CH CURRENT UNIT U8977		
Max. rated power	7 VA max. (at 500 A/55 Hz, $\pm$ 12 V power requirement)		7 VA max. (at 1000 A/55 Hz, $\pm$ 12 V power requirement)
Dimensions and mass	153 mm (6.02 in)W $\times$ 67 mm (2.64 in)H $\times$ 25 mm (0.68 in)D, 400 g (14.1 oz), cord length: 3 m (9.84 ft)	238 mm (9.37 in)W $\times$ 116 mm (4.57 in)H $\times$ 35 mm (1.38 in)D, 860 g (30.3 oz), cord length: 3 m (9.84 ft)	238 mm (9.37 in)W $\times$ 116 mm (4.57 in)H $\times$ 35 mm (1.38 in)D, 990 g (34.9 oz), cord length: 3 m (9.84 ft)
Included accessories	Instruction manual $\times$ 1, Mark bands $\times$ 6, Carrying Case $\times$ 1		

Note: These products cannot be used alone. The optional SENSOR UNIT is required in order to supply power and connect the clamp to a Memory HiCorder or other instrument. Products can be directly connected to the compatible Power Meters.

Current Sensors

**Options A**

**SENSOR UNIT CT9555**  
Power supply for current sensors (1ch, with waveform output)

**SENSOR UNIT CT9556**  
Power supply for current sensors (1ch, with waveform / RMS output)

**SENSOR UNIT CT9557**  
Power supply for current sensors (4ch, with waveform / total waveform / total RMS output)

**CONNECTION CORD L9217**  
Cord has insulated BNC connectors at both ends, 1.6 m (5.25 ft) length

**CONNECTION CORD 9165**  
Cord has metallic BNC connectors at both ends, use at metallic terminal, 1.5 m (4.92 ft) length

**Options C**

The CT9902 connects up to 2 cables in series (Accuracy addition required).

**CONVERSION CABLE CT9901**  
HIOKI ME15W (12 pin) to HIOKI PL23 (10 pin) connector

**EXTENSION CABLE CT9902**  
5 m (16.41 ft) length, HIOKI ME15W (12 pin) - HIOKI ME15W (12 pin) connector

**Options D**

For connecting to the P/V Unit 8940 or Current Unit 8971

**CONVERSION CABLE 9318**  
To connect HIOKI PL23 (10 pin) connector to the 8971/4051, 38 cm (14.96 in) length

## Power Supply for 4ch High-Precision Current Sensors Capable of Adding Current Waveforms

### SENSOR UNIT CT9557



- Power supply for high-precision current sensors with waveform output functionality
- Channel-specific waveform output, total waveform output, total RMS output
- Ideal for measuring multi-cable circuits

Model No. (Order Code) **CT9557** (For the CT6841A, etc., ME15W connector)

#### Basic specifications (Accuracy guaranteed for 1 year)

Connectable current sensors	Current sensors with a Hioki ME15W (male) output connector (CT6866-05, 9709-05, CT6846-05, etc.) *The separately available Conversion Cable CT9900 is required in order to use a current sensor equipped with a PL23 (10-pin) terminal
Output Terminal	BNC Terminal
Output voltage	Waveform output / Total waveform output: 2 V f.s. Total RMS output: 2 V DC f.s.
Output resistance	50 $\Omega$
Operating temperature range	-10 °C to 50 °C (14 °F to 122 °F)
Power supply	AC Adapter Z1002 (100 to 240 V AC, 50/60 Hz, maximum rated power when used with sensors: 155 VA) External power supply (10 to 30 V DC; maximum rated power: 60 VA)
Dimensions and mass	116 mm (4.57 in)W $\times$ 67 mm (2.64 in)H $\times$ 132 mm (5.20 in)D (excluding protruding parts), 420 g (14.8 oz)
Included accessories	AC Adapter Z1002 $\times$ 1, Power cord $\times$ 1, Instruction manual $\times$ 1

## Power Supplies for High-Precision Current Sensors

### SENSOR UNIT CT9555, CT9556



- Power supply for high-precision current sensors with waveform output functionality (CT9555)
- Power supply for high-precision current sensors with waveform output / RMS output functionality (CT9556)

Model No. (Order Code) **CT9555** (For the CT6841A, etc., ME15W connector)  
**CT9556** (For the CT6841A, etc., ME15W connector)

#### Basic specifications (Accuracy guaranteed for 1 year)

	CT9555	CT9556
Connectable current sensors	Current sensors with a Hioki ME15W (male) output connector (CT6866-05, 9709-05, CT6846-05, etc.) *The separately available Conversion Cable CT9900 is required in order to use a current sensor equipped with a PL23 (10-pin) terminal	
Output Terminal	BNC Terminal	
Output voltage	Waveform output: 2 V f.s.	Waveform output: 2 V f.s. RMS output: 2 V DC f.s.
Output resistance	50 $\Omega$	
Operating temperature range	-10 °C to 50 °C (14 °F to 122 °F)	
Power supply	AC Adapter Z1008 (100 to 240 V AC, 50/60 Hz, maximum rated power when used with sensors: 45 VA) External power supply (10 to 30 V DC; maximum rated power: 15 VA)	
Dimensions and mass	33 mm (1.30 in)W $\times$ 67 mm (2.64 in)H $\times$ 132 mm (5.20 in)D (excluding protruding parts), 200 g (7.1 oz)	
Included accessories	AC Adapter Z1008 $\times$ 1, Power cord $\times$ 1, Instruction manual $\times$ 1	

#### Shared options for CT9555, CT9556 and CT9557

**Options B**

**CONNECTION CABLE CT9904**  
ME15W (12 pin) terminal to ME15W (12 pin) terminal, 1 m (3.28 ft) length (for connecting CT9557 total output to PW8001, PW6001 or PW3390 only)

**CONNECTION CORD L9217**  
Cord has insulated BNC connectors at both ends, 1.6 m (5.25 ft) length

**CONNECTION CORD 9165**  
Cord has metallic BNC connectors at both ends, use at metallic terminal, 1.5 m (4.92 ft) length

**CONVERSION CABLE CT9900**  
PL23 (10 pin) to ME15W (12 pin) connector

**CONVERSION CABLE CT9901**  
ME15W (12 pin) to PL23 (10 pin) connector

## High-precision Current Testing

### AC/DC CURRENT PROBE CT6841A, CT6843A



- Combined accuracy with HIOKI power analyzer PW8001, PW6001 and PW3390 is specified (DC, 45 Hz ≤ f ≤ 66 Hz). For details of combined accuracy, refer to the instruction manual.
- Frequency bandwidth: DC to 2 MHz (CT6841A), DC to 700 kHz (CT6843A)
- Ideal for use in environmental testing with broad -40°C to 85°C temperature range
- Single-handed operation and robust locking mechanism
- Large jaw for clamping thick and paired wires (CT6845A, CT6846A)
- Power supplied via the measurement instrument (when connecting HIOKI POWER ANALYZER or MEMORY HiCORDER)
- Ideal for EV inverter evaluation and PV power generation PCS evaluation

Model No. (Order Code)	<b>CT6841A</b>	(20 A AC/DC, ME15W terminal)
	<b>CT6843A</b>	(200 A AC/DC, ME15W terminal)

Note: These products cannot be used alone. The optional SENSOR UNIT is required in order to supply power and connect the clamp to a Memory HiCorder or other instrument. Products can be directly connected to the compatible Power Meters.

#### Basic specifications (Accuracy guaranteed for 1 year)

	CT6841A	CT6843A
Rated current	20 A AC/DC	200 A AC/DC
Frequency characteristics	DC to 2 MHz	DC to 700 kHz
Core diameter	φ 20 mm (0.79 in)	
Max. allowable input	±60 Apeak (Within 20 ms in an environment of 40°C/104°F or less)	
Output voltage	100 mV/A	10 mV/A
Output resistance	50 Ω ± 10 Ω	
Accuracy (amplitude)	DC: ±0.2 % rdg +0.05 % f.s. DC < f ≤ 100 Hz ±0.2 % rdg ±0.01 % f.s.	DC: ±0.2 % rdg +0.02 % f.s. DC < f ≤ 100 Hz ±0.2 % rdg ±0.01 % f.s.
Linearity	±20 ppm Typical	
Common-Mode Voltage Rejection Ratio (CMRR)	DC to 1 kHz: 140 dB or greater 1 kHz to 10 kHz: 125 dB or greater 10 kHz to 100 kHz: 100 dB or greater 100 kHz to 1 MHz: 80 dB or greater (effect on output voltage and common mode voltage)	DC to 1 kHz: 150 dB or greater 1 kHz to 10 kHz: 135 dB or greater 10 kHz to 100 kHz: 115 dB or greater 100 kHz to 500 kHz: 95 dB or greater (effect on output voltage and common mode voltage)
Automatic phase correction	Automatically performs phase correction when connected to PW8001	
Operating temperature, humidity	-40 °C to +85 °C (-40 °F to 185 °F), 80% RH or less (with no condensation)	
Standards	Safety IEC 61010-2-032:2012/EN 61010-2-032:2012 Type D EMC IEC 61326-1:2012/EN 61326-1:2013	
Withstand voltage	AC 4,260 V	
Power supply	Power supplied via the Power Analyzer PW8001, PW6001, PW3390, Sensor Unit CT9555, CT9556, CT9557, or 3CH CURRENT UNIT U8977	
Max. rated power	5 VA max. (at 20 A/55 Hz, ±12 V power requirement)	6 VA max. (at 200 A/55 Hz, ±12 V power requirement)
Dimensions and mass	153 mm (6.02 in)W × 67 mm (2.64 in)H × 25 mm (0.98 in)D, cord length: 3 m (9.84 ft) CT6841A: 370 g (13.05 oz), CT6843A: 380 g (13.4 oz)	
Included accessories	Instruction manual ×1, Mark bands ×6, Carrying Case ×1	

Compatible models	CT6841A	CT6843A
Power Analyzer PW8001	✓	✓
Power Analyzer PW6001	✓	✓
Power Analyzer PW3390	✓	✓
3CH Current Unit U8977	✓	✓
Current Unit 8971	▲ (Requires 9318 and CT9901)	▲ (Requires 9318 and CT9901)

<b>Options A</b> SENSOR UNIT CT9555 Power supply for current sensors (1ch, with waveform output) SENSOR UNIT CT9556 Power supply for current sensors (1ch, with waveform/RMS output) SENSOR UNIT CT9557 Power supply for current sensors (4ch, with waveform/total waveform/total RMS output)	CONNECTION CORD L9217 Cord has insulated BNC connectors at both ends, 1.6 m (5.25 ft) length CONNECTION CORD 9165 Cord has metallic BNC connectors at both ends, use at metallic terminal, 1.5 m (4.92 ft) length	<b>Options C</b> CONVERSION CABLE CT9901 HIOKI ME15W (12 pin) to HIOKI PL23 (10 pin) connector EXTENSION CABLE CT9902 5 m (16.4 ft) length, HIOKI ME15W (12 pin) - HIOKI ME15W (12 pin) connector	<b>Options D</b> CONVERSION CABLE 9318 To connect HIOKI PL23 (10 pin) connector to the 8971/4051, 38 cm (14.96 in) length
---	--	---	---

## Ideal for Measuring AC Current with Low Frequencies such as Inverter Control Devices

### CLAMP ON SENSOR 9272



- Superior low frequency and phase characteristics suitable for testing the current and power of inverter control devices
- Wide 1 Hz to 100 kHz frequency bandwidth perfect for harmonic analysis, FFT analysis and waveform monitoring (AC only)

Model No. (Order Code)	<b>9272-05</b>	(20/200 A AC, ME15W terminal)
------------------------	----------------	-------------------------------

Note: This product cannot be used alone. The optional Sensor Unit is required in order to supply power and connect the clamp to a Memory HiCorder or other instrument. The clamp can be directly connected to a compatible Power Meters.



#### Basic specifications (Accuracy guaranteed for 1 year)

Rated current	20 A AC, or 200 A AC (selectable)	
Max. allowable input	50 A rms (at 20 A range), 300 A rms (at 200 A range)	
Frequency characteristics	1 Hz (±2 % rdg ±0.1 % f.s.) to 100 kHz (±30 % rdg ±0.1 % f.s.)	
Amplitude and Phase accuracy	Amplitude: ±0.3 % rdg ±0.01 % f.s. Phase: ±0.2 ° (45 to 66 Hz)	
Output voltage	2 V/20 A rated current range, or 2 V/200 A rated current range (This device outputs AC+DC voltage via the Sensor Unit.)	
Max. rated voltage to earth	600 V rms (CAT III)	
Core diameter	φ 46 mm (1.81 in)	
Power supply	Power supplied via the Power Analyzer PW8001, PW6001, PW3390, Sensor Unit CT9555, CT9556, CT9557, or 3CH CURRENT UNIT U8977	
Power consumption	5 VA Max. (when measuring 200 A)	
Dimensions and mass	78 mm (3.07 in)W × 188 mm (7.40 in)H × 35 mm (1.38 in)D, 430 g (15.2 oz), cord length: 3 m (9.84 ft)	
Included accessories	Carrying case 9355 ×1, Instruction manual ×1, Mark bands ×6	

Compatible models	(9272-10)	9272-05
Power Analyzer PW8001	▲ (Requires CT9900)	✓
Power Analyzer PW3390	▲ (Requires CT9900)	✓
3CH Current Unit U8977	▲ (Requires CT9900)	✓
Current Unit 8971	▲ (Requires the 9318)	▲ (Requires the 9318, CT9901)

<b>Options A</b> SENSOR UNIT CT9555 Power supply for current sensors (1ch, with waveform output) SENSOR UNIT CT9556 Power supply for current sensors (1ch, with waveform/RMS output) SENSOR UNIT CT9557 Power supply for current sensors (4ch, with waveform/total waveform/total RMS output)	CONNECTION CORD L9217 Cord has insulated BNC connectors at both ends, 1.6 m (5.25 ft) length CONNECTION CORD 9165 Cord has metallic BNC connectors at both ends, use at metallic terminal, 1.5 m (4.92 ft) length	<b>Options C</b> CONVERSION CABLE CT9901 HIOKI ME15W (12 pin) to HIOKI PL23 (10 pin) connector EXTENSION CABLE CT9902 5 m (16.4 ft) length, HIOKI ME15W (12 pin) - HIOKI ME15W (12 pin) connector	<b>Options D</b> CONVERSION CABLE 9318 To connect HIOKI PL23 (10 pin) connector to the 8971/4051, 38 cm (14.96 in) length
---	--	---	---

## Accurate, Long-term Recording and Easy Output Settings

### AC/DC AUTO-ZERO CURRENT SENSOR CT7700 series



CE  
CAT IV 600 V  
3 Year Warranty

- Accurately measure and record even when the temperature changes
- Ideal for site inspections by using detachable Display Unit
- Four output formats to output data to loggers or other devices (via Display Unit) WAVE, RMS, PEAK, Hz

Model No. (Order Code)	CT7742	(2000 A AC/DC, $\phi$ 55 mm (2.17 in))
	CT7736	(600 A AC/DC, $\phi$ 33 mm (1.30 in))
	CT7731	(100 A AC/DC, $\phi$ 33 mm (1.30 in))

Note: CT7700 series cannot be used alone. Use with the Display Unit CM7290, CM7291 to connect with Data Loggers and Memory HiCorders. When used in combination with CM7290 or CM7291, the frequency band of current display and waveform output becomes narrow.

#### Basic specifications (Accuracy guaranteed for 3 years)

	CT7742	CT7736	CT7731
Rated measurement current	2000 A AC/DC	600 A AC/DC	100 A AC/DC
Max. measurement current	2000 A (requires derating at frequency)	600 A (requires derating at frequency)	100 A (requires derating at frequency)
Max. allowable peak input	2840 A peak	900 A peak	150 A peak
Bandwidth	DC to 5 kHz (-3dB) (When used in combination with CM7290 or CM7291: DC 3 Hz to 1 kHz)		
Typical accuracy	$\pm 2.3$ deg. (DC < $f \leq 66$ Hz)	$\pm 1.8$ deg. (DC < $f \leq 66$ Hz)	$\pm 1.8$ deg. (DC < $f \leq 66$ Hz)
Output rate	0.1 mV/A	1 mV/A	1 mV/A
Max. rated voltage to earth	600 V AC/DC (CAT IV) 1000 V AC/DC (CAT III)	600 V AC/DC (CAT IV) 1000 V AC/DC (CAT III)	600 V AC/DC (CAT IV)
Core diameter	$\phi$ 55 mm (2.17 in) or less	$\phi$ 33 mm (1.30 in) or less	$\phi$ 33 mm (1.30 in) or less
Output connectors	HIOKI PL 14		
Operating temperature range	-25 °C to 65 °C (-13 °F to 149 °F)		
Dust and water resistance *	Jaws and barriers: IP50 / Grip: IP54 (when measuring insulated conductors only, Do not use when wet.)		IP40
Dimensions and mass	64 mm (2.52 in)W $\times$ 195 mm (7.68 in)H $\times$ 34 mm (1.34 in)D, 510 g (18.0 oz), Cable length 2.5 m (8.20 ft)	64 mm (2.52 in)W $\times$ 160 mm (6.30 in)H $\times$ 34 mm (1.34 in)D, 320 g (11.3 oz), Cable length 2.5 m (8.20 ft)	58 mm (2.28 in)W $\times$ 132 mm (5.20 in)H $\times$ 18mm (0.71 in)D, 250 g (8.8 oz), Cable length 2.5 m (8.20 ft)
Included accessory	None		

\* Waterproof characteristics intended to maintain measurement function; measuring energized parts while instrument is wet will increase risk of electric shock.

## Accurate, Instantaneous Waveforms Recording and Easy Output Settings

### AC/DC CURRENT SENSOR CT6600 series



CE  
CAT IV 600 V  
3 Year Warranty

- Ideal for observing instantaneous waveforms in laboratories and other temperature-controlled environments
- Ideal for site inspections by using detachable Display Unit
- Four output formats to output data to loggers or other devices (via Display Unit) WAVE, RMS, PEAK, Hz

Model No. (Order Code)	CT6642	(2000 A AC/DC, $\phi$ 55 mm (2.17 in))
	CT6636	(600 A AC/DC, $\phi$ 33 mm (1.30 in))
	CT6631	(100 A AC/DC, $\phi$ 33 mm (1.30 in))

Note: CT6600 series cannot be used alone. Use with the Display Unit CM7290, CM7291 to connect with Data Loggers and Memory HiCorders. When used in combination with CM7290 or CM7291, the frequency band of current display and waveform output becomes narrow.

#### Basic specifications (Accuracy guaranteed for 3 years)

	CT6642	CT6636	CT6631
Rated measurement current	2000 A AC/DC	600 A AC/DC	100 A AC/DC
Max. measurement current	2000 A (requires derating at frequency)	600 A (requires derating at frequency)	100 A (requires derating at frequency)
Max. allowable peak input	2840 A peak	900 A peak	150 A peak
Bandwidth	DC to 10 kHz (-3dB) (When used in combination with CM7290 or CM7291: DC 3 Hz to 1 kHz)		
Typical accuracy	$\pm 2.3$ deg. (DC < $f \leq 66$ Hz)	$\pm 1.8$ deg. (DC < $f \leq 66$ Hz)	$\pm 1.8$ deg. (DC < $f \leq 66$ Hz)
Output rate	0.1 mV/A	1 mV/A	1 mV/A
Max. rated voltage to earth	600 V AC/DC (CAT IV) 1000 V AC/DC (CAT III)	600 V AC/DC (CAT IV) 1000 V AC/DC (CAT III)	600 V AC/DC (CAT IV)
Core diameter	$\phi$ 55 mm (2.17 in) or less	$\phi$ 33 mm (1.30 in) or less	$\phi$ 33 mm (1.30 in) or less
Output connectors	HIOKI PL 14		
Operating temperature range	-25 °C to 65 °C (-13 °F to 149 °F)		
Dust and water resistance *	Jaws and barriers: IP50 / Grip: IP54 (when measuring insulated conductors only, Do not use when wet.)		IP40
Dimensions and mass	64 mm (2.52 in)W $\times$ 195 mm (7.68 in)H $\times$ 34 mm (1.34 in)D, 510 g (18.0 oz), Cable length 2.5 m (8.20 ft)	64 mm (2.52 in)W $\times$ 160 mm (6.30 in)H $\times$ 34 mm (1.34 in)D, 320 g (11.3 oz), Cable length 2.5 m (8.20 ft)	58 mm (2.28 in)W $\times$ 132 mm (5.20 in)H $\times$ 18mm (0.71 in)D, 250 g (8.8 oz), Cable length 2.5 m (8.20 ft)
Included accessory	None		

\* Waterproof characteristics intended to maintain measurement function; measuring energized parts while instrument is wet will increase risk of electric shock.

#### Shared options for CT7000 series

Display, Output	<p>DISPLAY UNIT CM7291 Power supply for the CT7000 series single drive, Measure, Display, Signal output function, built-in Bluetooth® wireless technology</p>	<p>DISPLAY UNIT CM7290 Power supply for the CT7000 series single drive, Measure, Display, Signal output function</p>	<p>EXTENSION CABLE L0220-01 2 m (6.56 ft) length</p>	<p>EXTENSION CABLE L0220-02 5 m (16.41 ft) length</p>	<p>EXTENSION CABLE L0220-03 10 m (32.81 ft) length</p>	<p>EXTENSION CABLE L0220-04 20 m (65.62 ft) length</p>	<p>EXTENSION CABLE L0220-05 30 m (98.43 ft) length</p>	<p>EXTENSION CABLE L0220-06 50 m (164.06 ft) length</p>	<p>EXTENSION CABLE L0220-07 100 m (328.11 ft) length</p>
	Case	<p>CARRYING CASE C0220 For storing sensor <math>\times</math>1, CM7290 <math>\times</math>1, AC adapter <math>\times</math>1, and output cord</p>	<p>CARRYING CASE C0221 For storing sensor <math>\times</math>3, CM7290 <math>\times</math>1, AC adapter <math>\times</math>1, output cord, and 30 m extension cable</p>						



## Multi-functional Display Unit to Use Right on the Field or Output to Advanced Recorder or Logger

### DISPLAY UNIT CM7290, CM7291



Bluetooth®

CM7290

CM7291 only

- Send measured values to a smartphone or tablet using Bluetooth® wireless technology (CM7291)
- Use the GENNECT Cross dedicated app to display and review measured values and waveforms in real time (CM7291)
- Power supply and signal output for Current Sensor CT7000 series
- Simultaneous dual display of the measured values, frequency, and output rate
- Four output formats to output data to loggers or other devices (via Display Unit)
- Supports AC adapter, AA alkaline batteries, and external power supply

Model No. (Order Code) **CM7290** (For the CT7000 series)  
**CM7291** (For the CT7000 series, with built-in Bluetooth® wireless technology)

Note: CM7290, CM7291 cannot be used alone. Use with CT7000 series. When used in combination with the CT7000 sensor series, the frequency band for current display and waveform output is narrower than the sensor band.

- Data can be downloaded to tablets and smartphones using Hioki's dedicated apps available from the Google Play or App Store. (CM7291)



\*Android, Google Play and the Google Play logo are trademarks of Google Inc.  
\*iOS is a registered trademark of Cisco Technology, Inc. and/or its affiliates in the United States and certain other countries.  
\*Phone, iPad, iPad mini, iPad Pro and iPod touch are trademarks of Apple Inc.  
\*Apple and the Apple logo are trademarks of Apple Inc. App Store is a service mark of Apple Inc.  
\*Microsoft, Windows, Windows Vista, and Excel are either registered trademarks or trademarks of Microsoft Corporation in the United States and/or other countries.  
\*Company names and Product names appearing in this catalog are trademarks or registered trademarks of various companies.  
\*The Bluetooth® word mark and logos are registered trademarks owned by Bluetooth SIG, Inc. and any use of such marks by HIOKI E.E. CORPORATION is under license.  
\*For the latest information about countries and regions where wireless operation is currently supported, please visit the Hioki website.

### Basic specifications (Accuracy guaranteed for 3 years)

Sensor	CT7642, 7742	CT7636, 7736	CT7631, 7731
Measurement parameters	DC, AC, DC+AC, Hz		
Crest factor	3 at 5000 count or 2.5 at 6000 count for AC and DC+AC		
Output method	WAVE, RMS, PEAK, FREQ		
Input connectors	HIOKI PL 14		
Output update time	PEAK--- FAST: 0.02 s / NORMAL: 0.2 s / SLOW: 1 s FREQ--- FAST: 0.2 s / NORMAL: 0.2 s / SLOW: 3.0 s (WAVE, RMS: analog output)		
PEAK sensing duration	2 ms or greater (during PEAK MAX/PEAK MIN and PEAK output)		
Other functions	Auto range, Zero adjustment at power-up, Analysis display, Filter, Output amplification, Display value hold, Backlight, Auto-power save, Save settings, keypad lock		
Typical accuracy (WAVE output DC)	±2.0% rdg ±10.8 mV (60.00 A range)	±2.5% rdg ±30.8 mV (60.00 A range)	±1.5% rdg ±5.8 mV (60.00 A range)
Typical accuracy (RMS output AC)	±2.3% rdg ±10.8 mV (60.00 A range)	±2.8% rdg ±30.8 mV (60.00 A range)	±1.8% rdg ±5.8 mV (60.00 A range)
Communication interface	Built in Bluetooth® 4.0 LE, Display of measured values on an iOS or Android handset (CM7291 only)		
Power supply	LR6 alkaline batteries (AA) ×2, Continuous use: 16 h (backlight OFF and WAVE or RMS output, when used with CT7600s), Rated power 2.5 VA or AC adapter 9445-02/03 (100 to 240V AC), or 5 to 15 V DC external power supply, Rated power 2.5 VA		
Dust and water resistance *	IP54 (with sensor connected and caps fitted to AC adapter and power connector)		
Dimensions and mass	52 mm (2.05 in)W × 163 mm (6.42 in)H × 37 mm (1.46 in)D, 220 g (7.8 oz) (including protector and battery)		
Included accessories	LR6 alkaline batteries ×2, Protector (attached to unit) ×1, Instruction manual ×1		

\* Waterproof characteristics intended to maintain measurement function; measuring energized parts while instrument is wet will increase risk of electric shock.



Connectable sensor 1	Connectable sensor 2	Output cord	Other options
<p>AC/DC AUTO-ZERO CURRENT SENSOR CT7742 2000 A AC/DC, φ 55 mm (2.17 in), 2.5 m (8.20 ft) cord length</p> <p>AC/DC AUTO-ZERO CURRENT SENSOR CT7736 600 A AC/DC, φ 33 mm (1.30 in), 2.5 m (8.20 ft) cord length</p> <p>AC/DC AUTO-ZERO CURRENT SENSOR CT7731 100 A AC/DC, φ 33 mm (1.30 in), 2.5 m (8.20 ft) cord length</p> <p>AC/DC CURRENT SENSOR CT7642 2000 A AC/DC, φ 55 mm (2.17 in), 2.5 m (8.20 ft) cord length</p> <p>AC/DC CURRENT SENSOR CT7636 600 A AC/DC, φ 33 mm (1.30 in), 2.5 m (8.20 ft) cord length</p> <p>AC/DC CURRENT SENSOR CT7631 100 A AC/DC, φ 33 mm (1.30 in), 2.5 m (8.20 ft) cord length</p> <p>AC FLEXIBLE CURRENT SENSOR CT7046 600/6000 A AC, φ 254 mm (10.00 in)</p> <p>AC FLEXIBLE CURRENT SENSOR CT7045 600/6000 A AC, φ 180 mm (7.09 in)</p> <p>AC FLEXIBLE CURRENT SENSOR CT7044 600/6000 A AC, φ 100 mm (3.94 in)</p>	<p>AC LEAKAGE CURRENT SENSOR CT7116 6 A AC, φ 40 mm (1.57 in), 2.5 m (8.20 ft) cord length</p> <p>AC CURRENT SENSOR CT7126 60 A AC, φ 15 mm (0.59 in), 2.5 m (8.20 ft) cord length</p> <p>AC CURRENT SENSOR CT7131 100 A AC, φ 15 mm (0.59 in), 2.5 m (8.20 ft) cord length</p> <p>AC CURRENT SENSOR CT7136 600 A AC, φ 46 mm (1.81 in), 2.5 m (8.20 ft) cord length</p>	<p>OUTPUT CORD L9094 Connect to Banana terminal, 1.5 m (4.92 ft) length</p> <p>OUTPUT CORD L9095 Connect to BNC terminal, 1.5 m (4.92 ft) length</p> <p>OUTPUT CORD L9096 Connect to terminal block, 1.5 m (4.92 ft) length</p>	<p>AC ADAPTER 9445-02 100 to 240 V AC</p> <p>MAGNETIC STRAP Z5004</p>

## Easy to loop around, even in confined spaces

### AC FLEXIBLE CURRENT SENSOR CT7040 series

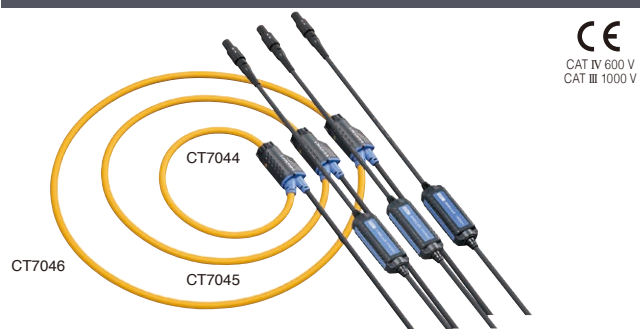

CAT IV 600 V  
CAT III 1000 V

- Thinner cables are easier to use in confined spaces and with complicated wiring
- Supports large current measurements up to 6000 A
- Wide 10 Hz to 50 kHz band with excellent frequency characteristics
- Choose from three conductor diameter sizes
- Ideal for site inspections by using detachable Display Unit
- Four output formats to output data to loggers or other devices (via Display Unit) WAVE, RMS, PEAK, Hz

Model No. (Order Code) **CT7046** (6000 A, φ254 mm (10.00 in))  
**CT7045** (6000 A, φ180 mm (7.09 in))  
**CT7044** (6000 A, φ100 mm (3.94 in))

Note: CT7040 series cannot be used alone. Use with the Display Unit CM7290, CM7291 to connect with Data Loggers and Memory HiCorders. When used in combination with CM7290 or CM7291, the frequency band of current display and waveform output becomes narrow. CT7046, CT7045, and CT7044 are a flexible current sensor for measuring large currents. It is not suitable for measuring minute current such as leakage current.

### Basic specifications (Accuracy guaranteed for 1 year)

	CT7046	CT7045	CT7044
Rated measurement current	6000 A AC		
Internal Measurement range	600A AC / 6000A AC (Range is controlled by main device)		
Max. allowable input	10000 A continuous (at 6000 A range, 45 to 66 Hz, requires derating)		
Bandwidth	10 Hz to 50 kHz (±3dB) (When used in combination with CM7290 or CM7291: 10 Hz to 1 kHz)		
Amplitude and phase accuracy	±1.5 % rdg ±0.25 % f.s. (f.s. is internal range, 45 to 66 Hz), ±1 deg		
Output rate	1 mV/A (600 A*), 0.1 mV/A (6000 A) *Selectable only when used with CM7290, CM7291, PQ3100		
Max. rated voltage to earth	600 V AC (CAT IV), 1000 V AC (CAT III)		
Loop diameter	φ 254 mm (10.00 in) or less	φ 180 mm (7.09 in) or less	φ 100 mm (3.94 in) or less
Dustproof, waterproof	IP54* (When sensor is connected to a compatible instrument.) * Do not use when met.		
Output connectors	HIOKI PL 14		
Operating temperature range	-25 °C to 65 °C (-13 °F to 149 °F)		
Dust and water resistance *	IP54 (when connected to a supported instrument, Do not make measurements when wet.)		
Dimensions	Flexible loop cable diameter: φ7.4 mm (0.29 in), Cable length: Between flexible loop and battery box: 2.3 m (7.55 ft), Output cable: 20 cm (0.66 ft), Battery box 25 mm (0.98 in)W × 72 mm (2.83 in)H × 20 mm (0.79 in)D		
Mass	186 g (6.6 oz)	174 g (6.1 oz)	160 g (5.6 oz)
Included accessory	Instruction manual ×1		

\* Waterproof characteristics intended to maintain measurement function; measuring energized parts while instrument is wet will increase risk of electric shock.



Display Output

DISPLAY UNIT CM7291  
Display of current sensor, signal output, built-in Bluetooth® wireless technology

DISPLAY UNIT CM7290  
Display of current sensor, signal output

## Easy to Loop Around, Even in Confined Spaces

### AC FLEXIBLE CURRENT SENSOR CT9667 series

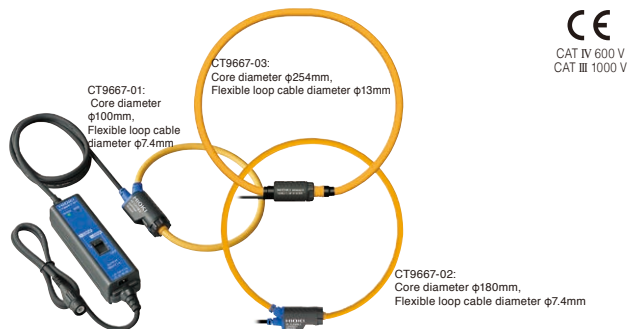

CE  
CAT IV 600 V  
CAT III 1000 V

CT9667-01:  
Core diameter  
 $\phi$ 100mm,  
Flexible loop cable  
diameter  $\phi$ 7.4mm

CT9667-03:  
Core diameter  $\phi$ 254mm,  
Flexible loop cable diameter  $\phi$ 13mm

CT9667-02:  
Core diameter  $\phi$ 180mm,  
Flexible loop cable diameter  $\phi$ 7.4mm

- Thinner cables are easy to use in confined spaces and with complicated wiring (-01, -02)
- Shaped so that it's easy to route through complex wiring
- Easily supports large current measurements up to 5000 A
- Wide 10 Hz to 20 kHz band with excellent frequency characteristics
- Choose from three conductor diameter sizes
- Combine with Hioki power meters or Memory HiCorders (with BNC input terminals)

Model No. (Order Code) **CT9667-01** ( $\phi$ 100 mm (0.30 in))  
**CT9667-02** ( $\phi$ 180 mm (7.09 in))  
**CT9667-03** ( $\phi$ 254 mm (10.00 in))

Note: These current sensors may also be used with HIOKI power quality analyzers, power meters or Memory HiCorders. CT9667 is a flexible current sensor for measuring large currents. It is not suitable for measuring minute current such as leakage current.

#### Basic specifications (Accuracy guaranteed for 1 year)

	CT9667-01	CT9667-02	CT9667-03
Rated input current	5000 A AC/ 500 A AC		
Max. allowable input	10000 A continuous (45 to 66 Hz, requires derating at frequency)		
Bandwidth	10 Hz to 20 kHz ( $\pm$ 3dB)		
Amplitude and phase accuracy	$\pm$ 2 % rdg $\pm$ 0.3 % f.s. (45 to 66 Hz, at center of flexible loop) Phase: $\pm$ 1 deg (45 to 66 Hz)		
Output voltage	500 mV AC/f.s. (0.1 mV AC/A) at 5000 A range 500 mV AC/f.s. (1 mV AC/A) at 500 A range		
Max. rated voltage to earth	1000 V AC (CAT III), 600 V AC (CAT IV)		
Core diameter	$\phi$ 100 mm (3.94 in)	$\phi$ 180 mm (7.09 in)	$\phi$ 254 mm (10.00 in)
Output terminal	BNC		
Operating temperature	-25 °C to +65 °C (-13 °F to 149 °F)	-25 °C to +65 °C (-13 °F to 149 °F)	-10 °C to +50 °C (14 °F to 122 °F)
Power supply	LR6 (AA) alkaline batteries $\times$ 2, Continuous use : 7 days (rated power 35 mVA), or AC adapter 9445-02-03 (rated power 0.2 VA), or External power supply 5 to 15 V DC (rated power 0.2 VA)		
Dust and water resistance	Flexible loop only: IP54		N/A
Dimensions and mass	Flexible loop cable diameter: $\phi$ 7.4 mm (0.29 in), Cable length: Between flexible loop and battery box: 2 m (6.56 ft), Output cable: 1 m (3.28 ft), Battery box: 35 mm (1.38 in)W $\times$ 120.5 mm (4.74 in)H $\times$ 34 mm (1.34 in)D, 280 g (9.9 oz)		Flexible loop cable diameter: $\phi$ 13 mm (0.51 in), Cable length: Between flexible loop and battery box: 2 m (6.56 ft), Output cable: 1 m (3.28 ft) Battery box: 35 mm (1.38 in)W $\times$ 120.5 mm (4.74 in)H $\times$ 34 mm (1.34 in)D, 470 g (16.6 oz)
Included accessories	LR6 (AA) alkaline batteries $\times$ 2, Instruction manual $\times$ 1		

Options



AC ADAPTER 9445-02  
100 to 240V AC



CONVERSION ADAPTER 9704  
Receiving side BNC (female), output banana (male) \*Not compatible with older generation Memory HiCorders with banana input terminals

## Simply Connect to a Tester or Recorder to Easily Measure Large Currents

### CLAMP ON PROBE 9132-50, 9010-50



CE  
CAT III 600 V

9132-50

9010-50

- Economical clamp sensors for waveform recording with Memory HiCorders
- Choose from up to six general-purpose ranges

Order Code **9132-50** (BNC output terminal)  
**9010-50** (BNC output terminal)

Note: For commercial power lines, 50/60 Hz (separate power supply not required).

#### Basic specifications (Accuracy guaranteed for 1 year)

	9132-50	9010-50
Rated current	20 A to 1000 A AC, 6 ranges	10 A to 500 A AC, 6 ranges
Accuracy	$\pm$ 3 % rdg $\pm$ 0.2 % f.s. (45 to 66 Hz)	$\pm$ 2 % rdg $\pm$ 1 % f.s. (45 to 66 Hz)
Frequency characteristics	Add to amplitude accuracy for frequencies from 40 to 1 kHz: $\pm$ 1 % rdg	Add to amplitude accuracy for frequencies from 40 to 1 kHz: $\pm$ 6 % rdg (at 10 A and 20 A range) $\pm$ 3 % rdg (for 50 A range and above)
Output rate	0.2 V AC f.s. (f.s. = setting range) (Connect to a voltage input device providing a high input impedance of 1 M $\Omega$ )	
Max. allowable input	1000 A rms continuous (all ranges) (For 40 Hz to 500 Hz: 100 %, and for 500 Hz to 1 kHz: within 90 % of derating)	150 A rms continuous (10/20/50 A ranges) 400 A rms continuous (100/200 A ranges) 650 A rms continuous (500 A range) (For 40 Hz to 100 Hz: 100 %, and for 100 Hz to 1 kHz: within 50 % of derating)
Max. rated voltage to earth	600 Vrms (50/60 Hz, CAT III)	
Core diameter	$\phi$ 55 mm (2.17 in), or 20 mm (0.79 in) $\times$ 80 mm (3.15 in) busbar	$\phi$ 46 mm (1.81 in)
Dimensions and mass	100 mm (3.94 in)W $\times$ 224 mm (8.82 in)H $\times$ 35 mm (1.38 in)D, 600 g (21.2 oz), cord length: 3 m (9.84 ft)	78 mm (3.07 in)W $\times$ 188 mm (7.40 in)H $\times$ 35 mm (1.38 in)D, 420 g (14.8 oz), cord length: 3 m (9.84 ft)
Included accessory	Instruction manual $\times$ 1	

Options



CONVERSION ADAPTER 9704  
Receiving side BNC (female), output banana (male) \*Not compatible with older generation Memory HiCorders with banana input terminals

## Superior Phase Characteristics Let You Record Waveforms Accurately

### CLAMP ON PROBE 9018-50



CE  
CAT III 600 V

- Choose from up to six general-purpose ranges
- Accurately record and analyze waveforms and harmonic signals

Order Code **9018-50** (BNC output terminal)

Note: For commercial power lines, 50/60 Hz (separate power supply not required).

#### Basic specifications (Accuracy guaranteed for 1 year)

Rated current	10 A to 500 A AC, 6 ranges
Accuracy	$\pm$ 1.5 % rdg $\pm$ 0.1 % f.s. (45 to 66 Hz)
Frequency characteristics	Add to amplitude accuracy : $\pm$ 1 % rdg Add to phase accuracy : $\pm$ 2.5 ° for frequencies from 40 Hz to 3 kHz
Output rate	0.2 V AC f.s. (f.s. = setting range) (Connect to a voltage input device providing a high input impedance of 1 M $\Omega$ )
Max. allowable input	150 A rms continuous (10/20/50 A ranges) 400 A rms continuous (100/200 A ranges) 650 A rms continuous (500 A range) (For 40 Hz to 100 Hz: 100 %, and for 100 Hz to 1 kHz: within 50 % of derating)
Max. rated voltage to earth	600 Vrms (50/60 Hz, CAT III)
Core diameter	$\phi$ 46 mm (1.81 in)
Dimensions and mass	78 mm (3.07 in)W $\times$ 188 mm (7.40 in)H $\times$ 35 mm (1.38 in)D, 420 g (14.8 oz), cord length: 3 m (9.84 ft)
Included accessory	Instruction manual $\times$ 1

Options





CONVERSION ADAPTER 9704  
Receiving side BNC (female), output banana (male) \*Not compatible with older generation Memory HiCorders with banana input terminals





## Sensors for Master to Branch Circuits

f.s. is the sensor's rated measurement current value.



**For load currents:** for the P03100/3198, CM7290/7291, and similar products (PL14 terminal)

Model No. (Order Code)	CT7126	CT7131	CT7136
			
Rated measurement current	60 A AC	100 A AC	600 A AC
Max. measurement current	Continuous 60 A (45 to 66 Hz)	Continuous 130 A (45 to 66 Hz)	Continuous 600 A (45 to 66 Hz)
Output rate	10 mV/A	1 mV/A	1 mV/A
Amplitude accuracy (45 to 66 Hz)	±0.3% rdg ±0.01% f.s.	±0.3% rdg ±0.02% f.s.	±0.3% rdg ±0.01% f.s.
Phase accuracy	±2° (45 Hz to 5 kHz)	±1° (45 Hz to 5 kHz)	±0.5° (45 Hz to 5 kHz)
Amplitude frequency characteristics	Within ±2.04% at 40 Hz - 20 kHz	Within ±2.05% at 40 Hz - 20 kHz	Within ±2.54% at 40 Hz - 20 kHz
Max. rated voltage to earth	300 V AC rms or less		1000 V AC rms or less
Measurable conductor diameter	φ 15 mm (0.59 in) or less		φ 46 mm (1.81 in) or less
Operating temperature and humidity	-10°C to 50°C (14°F to 122°F), 80% RH or less (no condensation)		
Dustproofness and waterproofness	IP40 (EN60529) (with sensor connected and jaw closed)		
Dimensions and mass	46 mm (1.81 in)W × 135 mm (5.31 in)H × 21 mm (0.83 in)D, 190 g (6.7 oz) Cable length 2.5 m (8.20 ft) (there is an optional extension cable), Output terminal: PL14		78 mm (3.07 in)W × 152 mm (5.98 in)H × 42 mm (1.65 in)D, 350 g (12.3 oz)



**For load currents:** for the PW3360 series, PW3198, 3197, 3169 series, MR8800 series, and similar products (BNC terminal)

Model No. (Order Code)	9694	9660	9661	9669
				
Rated measurement current	5 A AC	100 A AC	500 A AC	1000 A AC
Max. measurement current	Continuous 50 A (45 to 66 Hz)	Continuous 130 A (45 to 66 Hz)	Continuous 550 A (45 to 66 Hz)	Continuous 1000 A (45 to 66 Hz)
Output rate	10 mV AC/A	1 mV AC/A	1 mV AC/A	0.5 mV AC/A
Amplitude accuracy (45 to 66 Hz)	±0.3% rdg ±0.02% f.s.		±0.3% rdg ±0.01% f.s.	±1.0% rdg ±0.01% f.s.
Phase accuracy	±2° (45 Hz to 5 kHz)	±1° (45 Hz to 5 kHz)	±0.5° (45 Hz to 5 kHz)	±1° (45 Hz to 5 kHz)
Amplitude frequency characteristics	Within ±1% at 40 Hz - 5 kHz (deviation from amplitude accuracy)			Within ±2% at 40 Hz - 5 kHz (deviation from accuracy)
Max. rated voltage to earth	300 V AC rms or less		600 V AC rms or less	
Measurable conductor diameter	φ 15 mm (0.59 in) or less		φ 46 mm (1.81 in) or less	φ 55 mm (2.17 in) or less 80 × 20 mm, Bus bars
Operating temperature and humidity	0°C to 50°C (32°F to 122°F) 80% RH or less (no condensation)		0°C to 50°C (32°F to 122°F) 80% RH or less (no condensation)	
Dustproofness and waterproofness	N/A		N/A	
Dimensions and mass	46 mm (1.81 in)W × 135 mm (5.31 in)H × 21 mm (0.83 in)D, 230 g (8.1 oz) Cord length 3 m (9.84 ft), Output terminal: BNC		78 mm (3.07 in)W × 152 mm (5.98 in)H × 42 mm (1.65 in)D, 380 g (13.4 oz) H × 42 mm (1.65 in)D, 590 g (20.8 oz)	

**For leak currents:** for the P03100 (PL14 terminal) and similar products (BNC terminal)

Model No. (Order Code)	CT7116	9675	9657-10
			
Rated measurement current	6 A AC	10 A AC (for leak current measurement, 50/60 Hz)	
Max. measurement current (45 to 66 Hz)	Continuous 10 A	Continuous 10 A	Continuous 30 A
Output rate	100 mV AC/A	100 mV AC/A	100 mV AC/A
Amplitude accuracy (45 to 66 Hz)	±1.0% rdg ±0.05% f.s.	±1.0% rdg ±0.05% f.s.	±1.0% rdg ±0.05% f.s.
Phase accuracy (60 Hz or 60 Hz)	±3° or less	±5° or less	±3° or less
Amplitude frequency characteristics	40 Hz to 5 kHz	40 Hz to 5 kHz: ±5%	40 Hz to 5 kHz: ±3°
Residual current characteristics	Max. 5 mA (in 100 A go and return electric wire)	Max. 1 mA (in 10 A go and return electric wire)	Max. 5 mA (in 100 A go and return electric wire)
Effect of external magnetic field (400 A/m, 50 Hz / 60 Hz)	Corresponding to 5 mA 7.5 mA max.	7.5 mA max.	Corresponding to 5 mA 7.5 mA max.
Measurable conductor diameter	φ 40 mm (1.57 in) or less (Insulated conductor)	φ 30 mm (1.18 in) or less	φ 40 mm (1.57 in) or less
Operating temperature and humidity	-25°C to 65°C (-13°F to 149°F), 80% RH or less (no condensation)	0°C to 50°C (32°F to 122°F), 80% RH or less (no condensation)	
Dustproof, waterproof	IP40 (with sensor connected and jaw closed)	No regulation	
Dimensions and mass	74 mm (2.91 in)W × 145 mm (5.71 in)H × 42 mm (1.65 in)D, 340 g (12.0 oz), Cord length: 2.5 m (8.20 ft), Output terminal: PL14	60 mm (2.36 in)W × 112.5 mm (4.43 in)H × 23.6 mm (0.93 in)D, 160 g (5.6 oz), Cord length: 3 m (9.84 ft), Output terminal: BNC	74 mm (2.91 in)W × 145 mm (5.71 in)H × 42 mm (1.65 in)D, 380 g (13.4 oz), Cord length: 3 m (9.84 ft), Output terminal: BNC

**For load currents:** for the PW3198 and similar products

Model No. (Order Code)	9695-02	9695-03
		
Rated measurement current	50 A AC	100 A AC
Max. measurement current	Continuous 60 A (45 to 66 Hz)	Continuous 130 A (45 to 66 Hz)
Output rate	10 mV AC/A	1 mV AC/A
Amplitude accuracy (45 to 66 Hz)	±0.3% rdg ±0.02% f.s.	
Phase accuracy	±2° (45 Hz to 5 kHz)	±1° (45 Hz to 5 kHz)
Amplitude frequency characteristics	Within ±1% at 40 Hz - 5 kHz (deviation from amplitude accuracy)	
Max. rated voltage to earth	300 V AC rms or less (Insulated conductor)	
Measurable conductor diameter	φ 15 mm (0.59 in) or less	
Operating temperature and humidity	0°C to 50°C (32°F to 122°F), 80% RH or less (no condensation)	
Dimensions and mass	50.5 mm (1.99 in)W × 58 mm (2.28 in)H × 18.7 mm (0.74 in)D, 50 g (1.8 oz) Output terminal: M3 terminal (outside 3 mm, 0.12 inch diameter) Option: Connection cable 9219 (3 m, 9.84 ft length)	

f.s. is the sensor's rated measurement current value.

● 9695 OPTION CONNECTION CABLE 9219  
Connect with the 9695-02/-03, Output BNC terminal, 3 m (9.84 ft) length



## Clamp-type CT that enables measurement in excess of 1000 A (clamp ammeter option/AC use only)

### CLAMP ON ADAPTER 9290-10

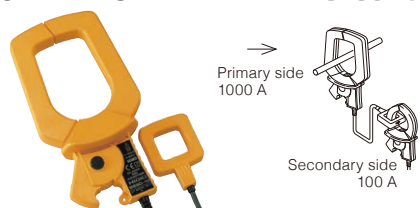

CE  
CAT III 600 V

■ Basic specifications (Accuracy guaranteed for 1 year)

Rated primary current	AC 1000 A continued (Maximum 1500 A for 5 minutes or shorter)
Rated secondary current	AC 100 A (10 : 1 CT ratio)
Amplitude accuracy	±1.5% rdg
Phase accuracy	±1.0° or less
Frequency characteristics	Amplitude: 20 Hz to 5 kHz: ±2.0% rdg (deviation from accuracy) Phase: 20 Hz to 5 kHz: ±1.0° or less (deviation from accuracy)
Max. rated voltage to earth	600 V AC rms (insulated wire)
Core jaw dia.	φ55 mm (2.17 in) or 80 mm (3.15 in) × 20 mm (0.79 in) bus-bar
Dimensions and mass	99.5 mm (3.92 in)W × 188 mm (7.40 in)H × 42 mm (1.65 in)D, 580 g (20.5 oz), cord length 3 m (9.84 ft)
Included accessories	Instruction manual ×1, Mark band ×6

Note: Cannot use with Model 9279

- Outputs large currents of 1000 A AC continuously (1500 A for 5 minutes) at a CT ratio of 10:1
- Expands the measurement range of normal clamp ammeters
- Excellent phase characteristics; also used to expand power meter measurement ranges

## Definitively Measure the White in Laser Displays - Specially Designed for RGB Lasers

**RGB LASER METER TM6102**  
**RGB LASER LUMINANCE METER TM6103**  
**OPTICAL POWER METER TM6104**



- Proprietary Discrete Centroid Wavelength Method for laser photometry
- RGB mixed light can be input directly
- Cut adjustment time in half with white balance navigation
- Measure up to 9 points on 12-inch\* screen simultaneously  
 \*12 inches: 4:3 250 mm × 180 mm (9.84 in × 7.09 in)
- Modulated light function for displays with a wide color gamut
- Low incidence angle dependence in chromaticity (TM6102)
- The oblique incident light properties are similar to the cosine law for angle of incidence (TM6102)
- For screens, backlights (TM6103)
- RGB laser module evaluation (TM6104)

Model No. (Order Code) **TM6102** (Illuminance)  
**TM6103** (Luminance)  
**TM6104** (Optical power)

### Basic specifications (Accuracy guaranteed for 1 year)

	TM6102	TM6103	TM6104
Measurement object	Laser light <i>Note: Accuracy is guaranteed with a laser light source. Accuracy is not guaranteed with standard illuminant A (light bulb).</i>		
Measurement parameters	Irradiance, illuminance, centroid wavelength	Radiance, luminance, centroid wavelength	Radiant flux (optical power), luminous flux, centroid wavelength
Radiometric quantity	Irradiance	Radiance	Radiant flux (Optical power)
Measurement range	0.0002 to 200 [W/m <sup>2</sup> ]	0.002 to 600 [W/sr • m <sup>2</sup> ]	0.00001 to 130 [mW]
Relative accuracy	±4.6% rdg (473 nm, 40 μW), Standard (532 nm, 60 μW), ±4.6% rdg (633 nm, 80 μW)	±4.6% rdg (473 nm, 40 μW), Standard (532 nm, 60 μW), ±4.6% rdg (633 nm, 80 μW)	N/A
Accuracy	±6.5% rdg (532 nm, 9 mW/m <sup>2</sup> )	±8% rdg (532 nm, 3 W/sr • m <sup>2</sup> )	±4.2% rdg (473 nm, 0.1 mW), ±4.2% rdg (532 nm, 0.1 mW), ±4.2% rdg (632.8 nm, 0.1 mW)
Photometric quantity	Illuminance	Luminance	Luminous flux
Measurement range	0.2 to 110 000 [lx]	2 to 300 000 [cd/m <sup>2</sup> ]	10 μlm to 60 lm
Centroid wavelength measurement range	Blue : 435 nm to 477 nm, Green : 505 nm to 550 nm, Red : 615 nm to 665 nm		
White balance adjustment assistance functions	(Set parameters) Target value of photometric quantity, tolerance of photometric quantity, target value of chromaticity (x, y), tolerance of chromaticity (x, y)		
Interfaces	LAN (TCP/IP) * A display is not available on the unit.		
Power supply	AC ADAPTER: Z1008 (100 V AC to 240 V AC, 9.5 VA)		
Dimensions and mass	65 mm (2.56 in) W × 83 mm (3.27 in) H × 126 mm (4.96 in) D, 700 g (24.7 oz)	65 mm (2.56 in) W × 83 mm (3.27 in) H × 175.7 mm (6.92 in) D, 790 g (27.9 oz)	65 mm (2.56 in) W × 83 mm (3.27 in) H × 135.5 mm (5.33 in) D, 720 g (25.4 oz)
Included accessories	AC ADAPTER: Z1008 ×1, Power cord ×1, Light shielding cap ×1, LAN cable (3 m, 9.84 ft length), Instruction manual ×1, Application disk CD-R (RGB Laser Utility application program) ×1		

## Laser Display Evaluation Lineup

### Multipoint Measurements for Laser Displays and Laser Projectors

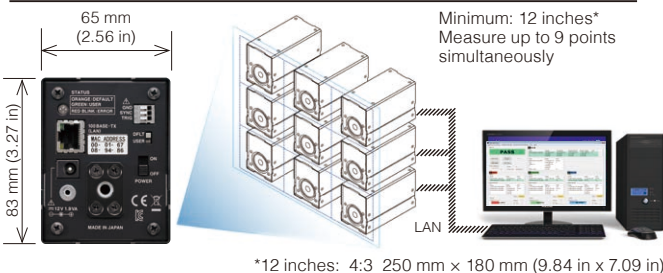

### Applicable in Any Measurement Scenario

Choose from three models to measure any display unit, including the latest HUDs (heads-up displays).

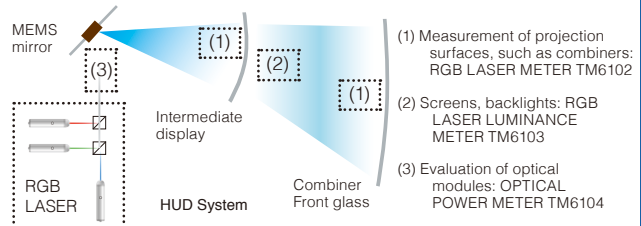

## Improve Productivity with Ultra-fast and High-precision Measurement!

**LED OPTICAL METER TM6101**



- Optical characteristic measuring instrument for white LED and LED lighting devices
- High-precision filter system delivers high speed and high precision
- Rapid measurement with approx. 5ms at its fastest
- Stability of chromaticity values is within ± 0.0001 (3σ)
- Influence caused by angle of incidence is within ± 0.001 for chromaticity values

Model No. (Order Code) **TM6101**

*Note: Can be connected to an integration sphere via a 1-inch port.*

### Basic specifications (Accuracy guaranteed for 1 year)

Measurement items	(1) Illuminance, Luminous flux, Luminous Intensity (2) Chromaticity (3) Color Rendering Index (4) Correlated Color Temperature and Δuv (5) Dominant wavelength and excitation purity
Measurement range	[Illuminance] 5 lx to 100000 lx
Applicable standard	Compliant with special type illuminance measuring instruments* specified in Japanese Industrial Standard (JIS) C 1609-1:2006 Illuminance meters Part 1: General measuring instruments. Performance (1) Illuminance linearity*: 2% ±1 dgt (2) Visible range relative special responsivity characteristics*: 1.5% *Terms translated into English by Hioki English translation of JIS C 1609-1:2006 has not been published by Japanese Standards Association. In the event of any doubt arising, the original standard in Japanese takes precedence.
Spectral responsivity characteristics of colour-matching functions	Performance: Meets with tolerance limits specified as Table 1 (Tolerance limits to deviation of spectral responsivity of photo-electric colorimeter) in 5.2 Photoelectric colorimeter of JIS Z 8724:1997 Methods of colour measurement - Light-source colour.
Compensation	Dark current compensation, Reference value compensation, (Illuminance, Luminous Intensity, Luminous Flux, Chromaticity)
Post-correction backup	Saving of user correction values: Reference value correction values can be saved on the connected computer
Interfaces	USB 2.0, Digital I/O (Input: External trigger, Output: End of measurement)
Optical detector	[Incoming radiation diameter] φ 11.3 mm ±0.1 mm
Measurement function	Control, Trigger function, Averaging, Auto-range function
Display	Illuminance, Luminous flux, Luminous Intensity, Chromaticity, Color Rendering Index, Correlated Color Temperature, Dominant wavelength
Power supply	AC adapter 9418-15 (100 to 240 V AC, 50/60 Hz, 6 VA)
Dimensions and mass	[Main unit] 210 mm (8.17 in)W × 30 mm (1.18 in)H × 135 mm (5.31 in)D, 1 kg (35.3 oz) [Sensor unit] 70 mm (2.76 in)W × 39.5 mm (1.56 in)H × 172 mm (6.77 in)D, 550 g (19.4 oz)
Included accessories	AC adapter 9418-15 ×1, USB cable ×1, Main unit/ sensor unit connection cable (2 m, 6.56 ft) ×1, Cap ×1, Connecting port connecting screws ×4, Ferrite cores ×3, Rubber feet ×4, Instruction manual ×1, CD-R (PC application software, Measurement library) ×1

## Handy Light Power Meter That's Ideal for Testing Lds for Optical Discs

### OPTICAL POWER METER 3664



USB 1.1



**Discontinuation scheduled**

#### Optional sensor for blue-violet optical lasers only (Sold separately)

OPTICAL SENSOR 9743  
(Handheld model)  
OPTICAL SENSOR 9743-10  
(Detachable model)

- 4.5 digits and broad dynamic range with 0.01 dBm resolution
- Automatic correction of sensor sensitivity using measurement wavelength input
- Remote operation on a computer screen and data capture via a USB connection
- Analog output function

Model No. (Order Code) **3664**

Note: This product cannot perform measurement alone. Please purchase an optional light sensor separately.

Use of Optical Sensor 9743/ 9743-10 that are exclusively for blue-violet optical lasers is not supported on earlier versions of Model 3664 (Version 1.01 or earlier). Please visit [www.hioki.com](http://www.hioki.com) to download the Hioki 3664 Setup Utility to enable compatibility of the Optical Sensors with all versions of Optical Power Meter 3664.

#### Basic specifications (Accuracy guaranteed for 1 year)

Measurement items	Optical power (W, dBm)
Measurable wavelength	Depends on optical sensor in use (option)
Measurable power	Depends on optical sensor in use (option)
Accuracy	±0.7 % (±5 % in combination with the optional sensor)
Wavelength sensitivity compensation	Can be set for every 1 nm, Automatic compensation for the sensor's sensitivity
Display	19999 max. Display resolution: 0.01 dBm / 0.01 dB, Measurement display unit: nW, μW, mW, dBm, dB
Analog output	Depends on optical sensor in use (option) (1 V approx. or 0.7 V approx. when the sensor calibration point input)
Functions	Scaling, Relative measurement, Max. value/ Min. value/ Average-value display, Auto power save, Setting backup, Battery check
Interfaces	USB 1.1 (Output measurement value and remote control)
Power supply	LR6 (AA) alkaline batteries ×4, Continuous use : 60 hr (using with the 9742 optical sensor as correction input), or AC adapter 9445-02, 1.6 VA max.
Dimensions and mass	85 mm (3.35 in)W × 160 mm (6.30 in)H × 35 mm (1.38 in)D, 270 g (9.5 oz) (without batteries)
Included accessories	AC adapter 9445-02 ×1, Output cord L9094 ×1, Driver software (CD-R) ×1, LR6 (AA) alkaline batteries ×4, USB cable ×1, Strap ×1, Instruction manual ×1



AC ADAPTER  
9445-02  
100 to 240 V AC

OUTPUT CORD L9094  
3.5 mm (0.14 in) dia. mini plug to banana, 1.5 m (4.92 ft) length

USB Cable  
1 m (3.28 ft) cord length

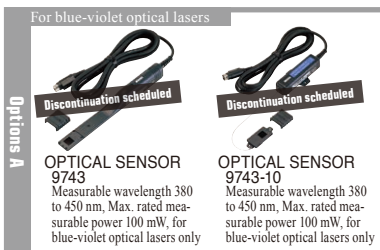

Options A

For blue-violet optical lasers

OPTICAL SENSOR 9743  
Measurable wavelength 380 to 450 nm, Max. rated measurable power 100 mW, for blue-violet optical lasers only

OPTICAL SENSOR 9743-10  
Measurable wavelength 380 to 450 nm, Max. rated measurable power 100 mW, for blue-violet optical lasers only

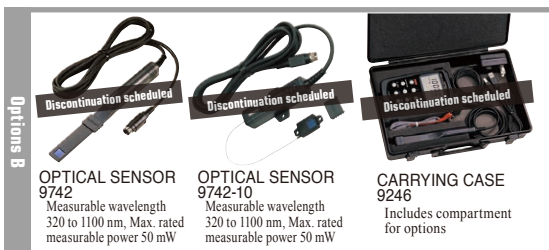

Options B

OPTICAL SENSOR 9742  
Measurable wavelength 320 to 1100 nm, Max. rated measurable power 50 mW

OPTICAL SENSOR 9742-10  
Measurable wavelength 320 to 1100 nm, Max. rated measurable power 50 mW

CARRYING CASE 9246  
Includes compartment for options

#### Optical sensor basic specifications (Accuracy guaranteed for 1 year)

	9742, 9742-10	9743, 9743-10
Measurable wavelength	320 nm to 1100 nm	380 to 450 nm
Measurable power	-59 dBm to +17 dBm (at the calibration wavelength)	-50 dBm to +20 dBm (at the calibration wavelength)
Max. rated measurable power	50 mW (+17 dBm) *at all direction irradiation	100 mW (+20 dBm) *at all direction irradiation
Optic receptacle element	Si photo-diode, 9.6 mm (0.38 in) × 9.6 mm (0.38 in)	Si photo-diode, 10 mm (0.39 in) × 10 mm (0.39 in)
Measurement accuracy	±4.3 % (±5 % in combination with the Optical power meter 3664)	±4.3 % (±5 % in combination with the Optical power meter 3664)
Calibration conditions	Calibration wavelength: 633 nm, Calibration power: 100 μW, φ 2 mm parallel beam, Perpendicular input to the center of optical sensor, by CW light	Calibration wavelength: 405 nm, Calibration power: 100 μW, φ 1.5 mm parallel beam, Perpendicular input to the center of optical sensor, by CW light
Dimensions and mass	See outline drawings; 100 g (3.5 oz)	See outline drawings; [9743] 100 g (3.5 oz) [9743-10] 110 g (3.9 oz)

#### OPTICAL SENSOR 9742

2 m (6.56 ft) cord length

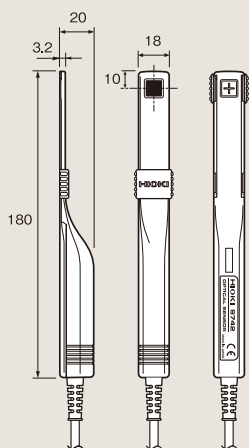

#### OPTICAL SENSOR 9742-10

2 m (6.56 ft) cord length

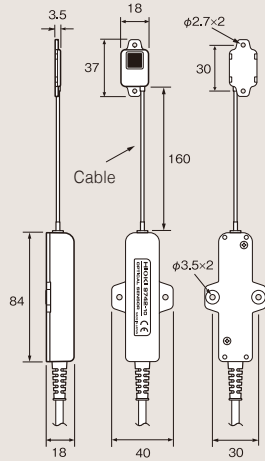

(can be secured with screws)

#### OPTICAL SENSOR 9743

2 m (6.56 ft) cord length

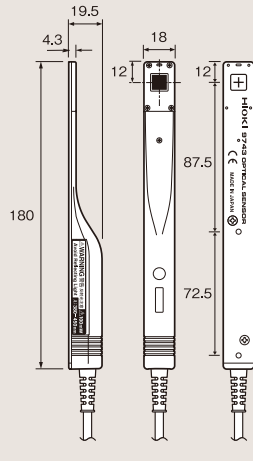

(can be secured with screws)

#### OPTICAL SENSOR 9743-10

2 m (6.56 ft) cord length

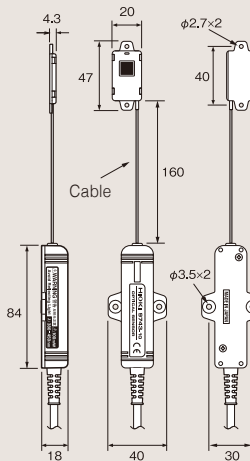

(can be secured with screws)

## A LAN Cable Tester Capable of Identifying the Location of Wire Breaks

### LAN CABLE HiTESTER 3665



#### Bundled accessories



TERMINATOR 9690 ID 0, ×1



CARRYING CASE Stores the 3665-20 and 9690

- Wire map check : Detect split pairs with wiring check
- Cable length : Get NVP-Enhanced measurement accuracy
- Direction check : Identify up to 21 cable destinations

Model No. (Order Code) **3665-20** (English model)

Note: For direction checks enabling individual wires to be identified, please purchase optional Terminators 9690-01 to -04.

#### Basic specifications (Accuracy guaranteed for 1 year)

Measurable cable	Twisted-pair cable, characteristic impedance: 100 Ω, shielded and unshielded, CAT 3, 4, 5, 5e, 6 and 6A
Compatible connectors	RJ-45 plugs
Wire Map test	Detectable errors: open, short, reversed, transposed, split pairs and other incorrect wiring (Wiring condition and shielding can be confirmed using the Terminator 9690)
Cable length measurement	Measurable lengths: 2 m to 300 m (6.6 ft to 984 ft) Measurement accuracy: ± 4 % rdg ± 1 m (3.3 ft) (condition of regulation: single wire) Display resolution: 0.1 m (0.3 ft)
Direction measurement	Up to 21 cables can be identified using the supplied Terminator 9690 and optional Models 9690-01 to 9690-04
Power supply	LR6 (AA) alkaline battery ×2, 1.4 VA max., Continuous use : 50 hr (at measurement interval of 1 minute)
Dimensions and mass	85 mm (3.35 in)W × 130 mm (5.12 in)H × 33 mm (1.30 in)D, 160 g (5.6 oz) (without batteries)
Included accessories	Terminator 9690 ×1, Carrying case ×1, LR6 (AA) alkaline battery ×2, Instruction manual ×1

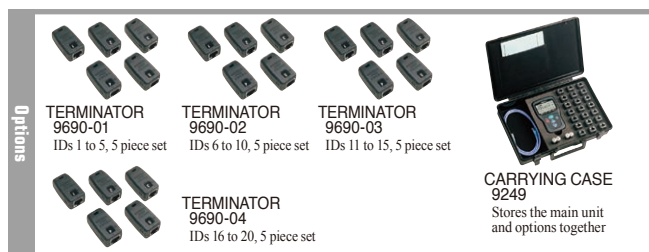

Options

TERMINATOR 9690-01  
IDs 1 to 5, 5 piece set

TERMINATOR 9690-02  
IDs 6 to 10, 5 piece set

TERMINATOR 9690-03  
IDs 11 to 15, 5 piece set

TERMINATOR 9690-04  
IDs 16 to 20, 5 piece set

CARRYING CASE 9249  
Stores the main unit and options together

## Inspect Solar Panel Bypass Diodes for Opens and Shorts in Broad Daylight Without Covering Panels

### BYPASS DIODE TESTER FT4310



#### Basic specifications (Accuracy guaranteed for 1 year)

Measurement items	Open-circuit voltage, Short-circuit current, Bypass route resistor
[BPD TEST mode]	
Measurement items	Bypass diode comparator judgment, Bypass route resistor, Open-circuit voltage, Short-circuit current, Measurement (applied) current
Measurement object	Crystal system string Open-circuit voltage: 1000 V DC or less, Rated current: 2 A to 12 A DC
Measurement method	Short-circuit and pulse voltage application
Measurement accuracy	Open-circuit voltage: $\pm 0.2\%$ rdg $\pm 3$ dgt (at 0 to $\pm 1000$ V) Short-circuit current: $\pm 3\%$ rdg $\pm 3$ dgt (at 0.0 to 15.0 A) Bypass route resistance: $\pm 5\%$ rdg $\pm 5$ dgt (at 0.0 to 15.0 $\Omega$ , During pure resistance measurement)
Measurement time	2 s or less (3 seconds or less when measurement voltage is 10 V or less)
Possible number of measurements	3000 times (Comparator, backlight, Bluetooth* OFF) LR6 Alkaline battery $\times 6$
[Voc mode]	
Measurement items	Open-circuit voltage
Measurement range	0 V to 1000 V DC (Displayed up to 1200 V DC), Accuracy: $\pm 0.2\%$ rdg $\pm 3$ dgt
Response time	Within 1 sec.
[General]	
Dustproof and waterproof	IP40 (EN60529)
Functions	Displays the number of bypass diode measurements, Automatic polarity judgment, function, Comparison display, Auto hold, Live circuit indicator, Buzzer sounds, Backlight, Comparator, Battery indicator, Auto power off, Bluetooth* wireless technology
Interface	Bluetooth* 4.0LE, Display of measured values on an iOS or Android handset
Power supply	LR6 (AA) alkaline battery $\times 6$ , Maximum rated power 18 VA Continuous operating time: 45 hours (Comparator, backlight, Bluetooth* OFF)
Dimensions and mass	152W $\times$ 92H $\times$ 69D mm (5.98 W $\times$ 3.62 H $\times$ 2.72 D in) 650 g (22.9 oz) (including batteries, excluding test leads)

- Test for open or short-circuit bypass diodes even during the day\*1
- Easily test using the strings in the junction boxes\*2
- Save time - simultaneously measure all electrical parameters\*3
- Automatically transfer data wirelessly (Available for Android and iOS devices\*4)

\*1 Testing can also be performed at night. Testing for short-circuit faults can only be performed during the day.  
\*2 There is no need to climb onto the roof and dramatically improving work efficiency.  
\*3 Measure open-circuit voltage, short-circuit current, and bypass route resistance and display all three values at once.  
\*4 Automatically transfer data with Bluetooth\* wireless technology

Model No. (Order Code) **FT4310** (Built-in Bluetooth\* wireless technology)

Note: The FT4310 cannot measure strings installed in parallel. Please contact Hioki for more information.

■ Data can be downloaded to tablets and smartphones using Hioki's dedicated apps available from the Google Play or App Store. Search for "HIOKI" and download the "GENNECT Cross" app.



\*Android, Google Play and the Google Play logo are trademarks of Google Inc.  
\*iOS is a registered trademark of Cisco Technology, Inc. and/or its affiliates in the United States and certain other countries.  
\*iPhone, iPad, iPad mini, iPad Pro and iPod touch are trademarks of Apple Inc.  
\*Apple and the Apple logo are trademarks of Apple Inc. App Store is a service mark of Apple Inc.  
\*Microsoft, Windows, Windows Vista, and Excel are either registered trademarks or trademarks of Microsoft Corporation in the United States and/or other countries.  
\*Company names and Product names appearing in this catalog are trademarks or registered trademarks of various companies.  
\*The Bluetooth\* word mark and logos are registered trademarks owned by Bluetooth SIG, Inc. and any use of such marks by HIOKI E.E. CORPORATION is under license.  
\*For the latest information about countries and regions where wireless operation is currently supported, please visit the Hioki website.

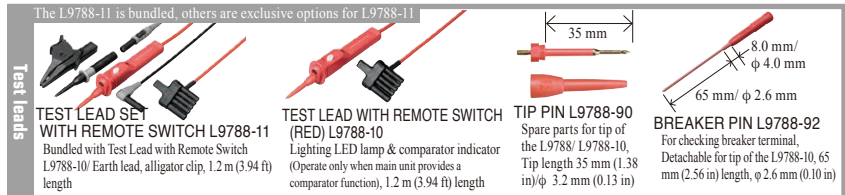

### Easily inspect bypass diodes for open and short-circuit faults even in broad daylight

#### Reference Issues caused by faulty bypass diodes

**Normal reading:** Current is routed around panels that are covered by shadows

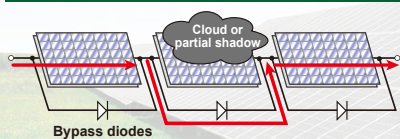

When a solar panel is obscured by a partial shadow (or when it fails), the current bypasses the panel in order prevent any drop-off in generating efficiency.

**Short-circuit fault:** Generating capacity falls

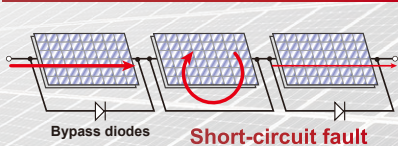

When a short-circuit fault occurs, the generated current flows in a loop, making it impossible to capture the generated power, resulting in lowered efficiency.

**Open fault:** Potential fire

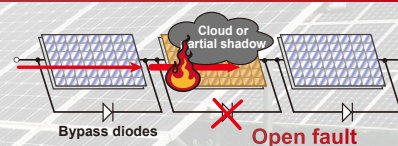

When an open fault occurs, current is forced to flow to the defective cell when it's covered by a shadow, causing the panel to heat up and posing the risk of fire.

## Robust Support for 3-Axis Magnetic Flux Density Measurement

### MAGNETIC FIELD HITESTER FT3470



- Complies with ICNIRP 2010 guidelines as well as other relevant standards for evaluation testing.
- Complies with IEC 62110/IEEE 644 as well as IEC 62233.
- Bundled with 3 cm<sup>2</sup> Sensor used for magnetic field distribution analysis, and 100 cm<sup>2</sup> Sensor used with the IEC/EN 62233 standard analysis
- User-selectable display units (T, A/m, and G)
- Simple operation for easy measurement
- Bundled with PC application software
- Level output for RMS value, or 3-axis waveform output for magnetic fields



**100 cm<sup>2</sup> Sensor**  
(FT3470-51 and FT3470-52 bundled)  
Cross-sectional area: 100 cm<sup>2</sup>, Standard sensor for use with the IEC/EN 62233 standard.



**3 cm<sup>2</sup> Sensor**  
(FT3470-52 only bundled)  
Cross-sectional area: 3 cm<sup>2</sup>, Enables detailed analysis of magnetic field distribution for measurement targets.

Model No. (Order Code) **FT3470-51** (100 cm<sup>2</sup> Sensor bundled)  
**FT3470-52** (100 cm<sup>2</sup> Sensor, 3 cm<sup>2</sup> Sensor bundled)

#### Basic specifications (Accuracy guaranteed for 1 year)

Magnetic flux density (Bandwidth)	10 Hz to 400 kHz/ 10 Hz to 2 kHz/ 2 kHz to 400 kHz
Exposure level	General Public/ Occupational
Display	Single axes X, Y, Z (2000 counts), Composite RMS value R (3464 counts), Magnetic flux density (unit: T, G, A/m), Exposure level (unit: %)
Magnetic flux density/ Ranges, Accuracy	[X, Y, Z axes] Effective measuring ranges: 2.000 μT to 2.000 mT, 4 ranges, Accuracy: ±3.5% rdg ±0.5% f.s. [R axis] Effective measuring ranges: 3.464 μT to 3.464 mT, 4 ranges, Accuracy: ±3.5% rdg ±0.5% f.s. [Valid measurement frequency range] at 10 Hz-400 kHz mode: 50 Hz to 100 kHz, at 10 Hz-2 kHz mode: 50 Hz to 1 kHz, at 2 kHz-400 kHz mode: 5 kHz to 100 kHz
Exposure level/ Ranges, Accuracy	[X, Y, Z axes] Effective measuring ranges: 20.00 % to 200.0 %, 2 ranges [R axis] Effective measuring ranges: 34.64 % to 346.4 %, 2 ranges, Accuracy: Smoothed edges 50 Hz to 1 kHz ±3.5% rdg ±0.5% f.s. Accuracy: Smoothed edges 1 kHz to 100 kHz ±5.0% rdg ±0.5% f.s.
Interfaces	[Supporting output] Resultant RMS level output, Exposure level output, Waveform output of magnetic flux density X/ Y/ Z each axis, Output rate: 0.1 mV/display value count [USB 1.1] Data saving with the PC application
Other functions	Memory function: Up to 99 measured value data, Slow function, Holds the maximum value, Auto power off, Buzzer sound on/off
Power supply	LR6 (AA) alkaline battery ×4, 0.8 VA (at battery operation), Continuous use of 10 hr, or AC adapter 9445-02 (1.0 VA max. consumption)
Dimensions and mass	Main unit: 100 mm (3.94 in)W × 150 mm (5.91 in)H × 42 mm (1.65 in)D, 830 g (29.3 oz), (including batteries) 100 cm <sup>2</sup> Sensor: φ122 mm (4.80 in) × 295 mm (11.61 in)L, 220 g (7.8 oz) 3 cm <sup>2</sup> Sensor: □ 27 mm (1.06 in) × 165 mm (6.50 in)L, 95g (3.4 oz)
Included accessories for the FT3470-51	100 cm <sup>2</sup> Sensor ×1, Instruction manual ×1, CD-R (PC application software Data Viewer for FT3470) ×1, USB cable ×1, LR6 (AA) alkaline battery ×4, AC adapter 9445-02 ×1, Carrying case ×1
Included accessories for the FT3470-52	100 cm <sup>2</sup> Sensor ×1, 3 cm <sup>2</sup> Sensor ×1, Instruction manual ×1, CD-R (PC application software Data Viewer for FT3470) ×1, USB cable ×1, LR6 (AA) alkaline battery ×4, AC adapter 9445-02 ×1, Extension cable 9758 ×1, Output cable 9759 ×1, Carrying case ×1

#### Bundled PC application software (DATA VIEWER for the FT3470)

Operating environment	Computer running under Windows 7 (32/64-bit), Vista (32/64-bit), XP
Functions	RMS value data logging/ Save to a PC in a batch, CSV file format

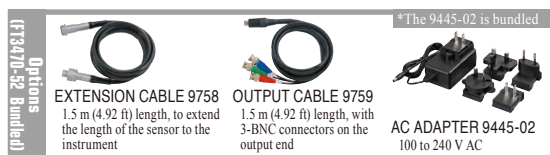



## Non-Contact Infrared Thermometer Featuring Simple, One-Touch Measurement

### INFRARED THERMOMETER FT3700, FT3701



- Pistol design with easy-to-see display
- A full menu of basic measuring functions
- Easily test in difficult locations, moving objects or where there is danger of electric shock

Model No. (Order Code) **FT3700-20** (Long-focus type)  
**FT3701-20** (Long focus, precise-field type)

Note: Laser Product Caution Notice

A caution label is attached to the thermometer. Be sure to observe the operating precautions on the label.



#### Basic specifications (Accuracy guaranteed for 1 year)

	FT3700-20	FT3701-20
Measurement temperature range	-60.0 to 550.0 °C (-76 to 1022 °F), 0.1 °C resolution	-60.0 to 760.0 °C (-76 to 1400 °F), 0.1 °C resolution
Accuracy	-35.0 to -0.1 °C (-31.0 to 31.9 °F) : ±10 %rdg ±2 °C 0.0 to 100.0 °C (-32.0 to 212.0 °F) : ±2 °C 100.1 to 500.0 °C (212.1 to 932.0 °F) : ±2% rdg <i>Note) -60.0 to -35.1 °C (-76.0 to -31.1 °F), and over 500.1 °C (932.0 °F) : Accuracy not specified</i>	
Response time	1 sec (90%)	
Measurement wavelength	8 to 14 μm	
Thermal emissivity compensation	ε=0.10 to 1.00 (0.01 step)	
Measurement field diameter	φ 83 mm at 1000 mm (3.27 in at 3.28 ft) (Distance : Spot = 12 : 1)	φ 100 mm at 3000 mm (3.94 in at 9.84 ft) (Distance : Spot = 30 : 1)
Sighting	Two-beam laser marker Max 1 mW (class 2), Red	
Functions	Continuous measurement mode, MAX/ MIN/ DIF (MAX - MIN)/ AVG measurement, Alarm, Backlight, Auto power-off	
Power supply	LR03 (AAA) alkaline battery ×2, 150 mVA, Continuous use of 140 hours (With laser marker, backlight and buzzer are OFF)	
Dimensions and mass	48 mm (1.89 in)W × 172 mm (6.77 in)H × 119 mm (4.69 in)D, 256 g (9.0 oz), (including batteries)	
Included accessories	Instruction manual ×1, LR03 alkaline battery ×2, Carrying case ×1	

FT3700-20 Measurement distance and field diameter

FT3701-20 Measurement distance and field diameter

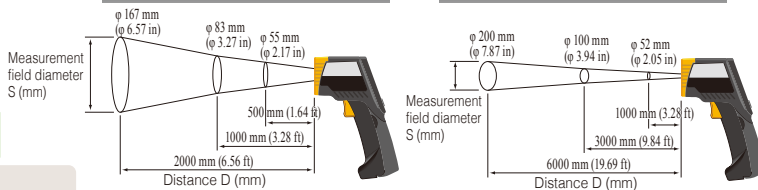

## Convenient Measurement of Sound Levels from Electrical Equipment and Machinery

### SOUND LEVEL METER FT3432



Hand strap VM-63-017 (Bundled)

- Simple operation, no range switching needed
- Compact, lightweight design for easy one-handed operation
- 30 dB to 137 dB
- Analog output

Model No. (Order Code) **FT3432**

#### Basic specifications (Accuracy guaranteed for 1 year)

Applicable standards	IEC 61672-1: 2013 Class 2, JIS C 1509-1:2017 Class2, JIS C 1516:2014 Class2
Measurement functions	Sound level, Equivalent continuous sound level, Sound exposure level, Maximum Sound level, C weighting peak sound level (measurement possible only when peak range is selected)
Measurement times	1/5/10 minutes, or 1 hour
Frequency weighting characteristics	A weighting, or C weighting
Measurement level range	[Wide range] A weighting: 30 dB to 137 dB, C weighting: 36 dB to 137 dB [Peak range] A weighting: 65 dB to 137 dB, C weighting: 65 dB to 137 dB
Frequency range	20 Hz to 8000 Hz
Microphone	1/2-inch electret condenser microphone
Time weighting characteristics	Fast, or Slow
Other functions	Storing processing results (Storing capacity : 199 pieces of data), Warning indications, Bar graph
Output	DC output connector: DC output: 3 V (full scale), 25 mV/dB, Output impedance: 50 Ω AC monitor output connector: AC output: 1 Vrms +600 mVrms, -400 mVrms (at 110 dB) (Upper limit: 1.8 Vrms), Output impedance: 600 Ω, Frequency weighting characteristics: Z weighting
Power supply	LR03 (AAA) alkaline battery ×2, Continuous use 9 hr at wide range, R03 (AAA) manganese battery ×2, Continuous use 3 hr at wide range, Consumption: 80 mA
Dimensions and mass	63 mm (2.48 in)W × 120 mm (4.72 in)H × 23.5 mm (0.93 in)D, 105 g (3.7 oz), (including batteries)
Included accessories	Wind screen WS-14 ×1, Hand strap VM-63-017 ×1, Windscreen fall out prevention rubber NL-27-014 ×1, Silicon cover NL-27-089 ×1, Carrying Case 9757 ×1, LR03 (AAA) alkaline batteries ×2, Instruction manual ×1

Options

- AC MONITOR OUTPUT CABLE CC-98A
- DC OUTPUT CABLE CC-98D
- SOUND LEVEL METER TRIPOD ST-80
- TRIPOD EXTENSION ROD ST-80-100
- CARRYING CASE 9757 Soft type

\*Carrying case 9757 is bundled

## High Reliability LUX METER Series, Complies with DIN Class B and JIS Class AA, Compatible with LED/OLED Lighting

### LUX METER FT3424, FT3425



FT3424



Bluetooth®  
FT3425



Sensor unit and main display can be separated. Sold separately

USB 2.0

CE

3 Year Warranty

- Measured illuminance data is automatically sent to smartphone or tablet with Bluetooth® wireless technology (FT3425)
- Compatible with LED/OLED lighting
- Complies with DIN 5032-7:1985 class B and JIS C 1609-1:2006 general AA class
- Timer hold function lets you make measurements in remote locations while avoiding the effects of shadows and reflections
- Save up to 99 measured values in the instrument's internal memory and transfer them to a computer later for improved work efficiency

#### Basic specifications (Accuracy guaranteed for 2 years)

Standards	DIN 5032-7: 1985 class B, JIS C 1609-1: 2006 general AA class
Light receiving element	Silicon photo diode
Range selection	Auto/ Manual
Linearity	±2% rdg (Multiply by 1.5 for display values in excess of 3000 lx.)
Accuracy guarantee for temperature and humidity	21 °C to 27 °C (69.8 °F to 80.6 °F), 75% rh or less (non-condensing)
Response time	Auto range: within 5 seconds, Manual range: within 2 seconds
D/A output	Output level: 2 V/range f.s. (2.5 V is output when the range f.s. is exceeded.) Output accuracy: ±1% rdg ±5 mV (at display count)
Functions	Timer hold function, Memory function (Up to 99 measured data can be saved), Hold, Auto power off, Buzzer sound, Backlight, Zero adjustment
Interfaces	USB 2.0 (FT3424/FT3425), Bluetooth® 4.0LE (FT3425 only)
Power supply	LR6 Alkaline battery ×2, Max. rated power 500 mVA, or R6 Manganese battery ×2, or USB bus power (5 VDC)
Continuous battery operation time	300 hours (when using LR6 batteries, with Bluetooth® OFF), 80 hours (when using LR6 batteries, with Bluetooth® ON)
Dimensions and mass (including the batteries)	78 mm (3.07 in)W × 170 mm (6.69 in)H × 39 mm (1.54 in)D, 310 g (10.9 oz, FT3424) / 320 g (11.3 oz, FT3425)
Included accessories	Instruction Manual ×1, AA/LR6 Alkaline battery ×2, Sensor cap (with strap) ×1, Carrying case (soft) ×1, Strap (for instrument) ×1, USB cable (0.9 m/2.95 ft) ×1, CD (USB driver, dedicated computer application software, and communications specifications) ×1, Precautions Concerning Use of Equipment that Emits Radio Waves ×1 (only FT3425)

Only FT3425 is equipped with Bluetooth® wireless technology, others are shared specifications

#### Measurement ranges

Range	Measurement range	Display steps
20 lx	0.00 lx to 20.00 lx	1 count step
200 lx	0.0 lx to 200.0 lx	1 count step
2000 lx	0 lx to 2000 lx	1 count step
20000 lx	00 lx to 20000 lx	10 count step
200000 lx	000 lx to 200000 lx	100 count step

- Data can be downloaded to tablets and smartphones using Hioki's dedicated apps available from the Google Play or App Store. (FT3425 only)
- Search for "HIOKI" and download the "GENNECT Cross" app.



Model No. (Order Code) **FT3424**  
**FT3425** (Built in Bluetooth(R) wireless technology)

Options

Extendible length: 0.5 m (1.64 ft) to 1.6 m (5.25 ft)

Mounting method of instrument  
**EXTENSION CART Z5023**  
This cart with caster wheels can be easily moved between measurement locations.

**CONNECTION CABLE L9820**  
Use when positioning the sensor unit and display unit separately during use. 2 m (6.56 ft) length

**OUTPUT CORD L9094**  
3.5 mm (0.14 in) dia. mini plug to banana, 1.5 m (4.92 ft) length

**OUTPUT CORD L9095**  
Connect to BNC terminal, 1.5 m (4.92 ft) length

**OUTPUT CORD L9096**  
Connect to terminal block, 1.5 m (4.92 ft) length

**CARRYING CASE C0202**  
Soft case

**CARRYING CASE C0201**  
Semi-hard case

C0202: For storing the instrument with the CONNECTION CABLE, OUTPUT CORD, and USB Cable  
C0201: For storing the instrument with OUTPUT CORD and USB Cable

## Temperature Probes

### Probe specifications (9472, 9473, 9474, 9475: Waterproof construction)

Model (Order Code)	9472 (Discontinued)	9473 (Discontinued)	9474	9475
Material type	K type thermocouple (Chromel / Almel)			
Contact type	Non-grounded	Non-grounded	Non-grounded	Non-grounded
Tolerance	*2			
Response (90%)*1	About 5 sec	About 10 sec	About 5 sec	About 10 sec
Size of Sheath (mm), (inch)	φ 2.3 × 150 (mm) φ 0.09 × 5.91 (in)	φ 4.8 × 300 (mm) φ 0.19 × 11.81 (in)	φ 2.3 × 100 (mm) φ 0.09 × 3.94 (in)	φ 4.8 × 100 (mm) φ 0.19 × 3.94 (in)
Compensation lead	Conventional type (-20 to 90°C, -4 to 194°F), 1m (3.28 ft)			
Grip heat resistance	80 °C (176 °F)			
Measurement temperature	-100 to 300 °C -148 to 572 °F	0 to 800 °C 32 to 1472 °F	-100 to 300 °C -148 to 572 °F	-100 to 500 °C -148 to 932 °F

\*1 Sheath type: Responsiveness in ice water at 0 °C (32 °F) and in boiling water at 100 °C (212 °F)  
Surface type: Responsiveness on a metal surface at 0 °C (32 °F) and at 100 °C (212 °F)  
\*2 At -40 °C (-40 °F) and more, the greater of ±1.5 °C (±2.7 °F) and ±0.4 % of the measured value  
\*3 ±2.5 °C [(T-Ts) ≤ 100 °C], -0.03 × T °C to +2.5 °C [100 °C < (T-Ts)],  
T: measured temperature (-40 °C to 500 °C), Ts: environmental temperature (0 °C to 40 °C)

### Probe specifications

Model (Order Code)	9180 (Discontinued)	9183	9181
Material type	K type thermocouple (Chromel / Almel)		
Contact type	Non-grounded	Grounded	
Tolerance	9180: *4 9183: *2	±2.5 °C (±4.5 °F) [(T-Ts) ≤ 100 °C (180 °F)] -0.035 × T °C to +2.5 °C [100 °C (180 °F) < (T-Ts)] T: measurement temp. (-50 °C to 400 °C) Ts: environment temp. (0 °C to 50 °C)	
Response (90%)*1	About 5 sec		About 3 sec
Size of Sheath (mm), (inch)	φ 3.2 × 150 (mm) φ 0.13 × 5.91 (in)		φ 13 (mm) φ 0.51 (in)
Compensation lead	Conventional type (-20 to 90°C, -4 to 194°F), 1m (3.28 ft)		
Grip heat resistance	150 °C (302 °F), Grip size φ 13 × 100 mm (φ 0.51 in × 3.94 in)		
Measurement temperature	-50 to 750 °C -58 to 1382 °F		-50 to 400 °C -58 to 752 °F

\*1 Sheath type: Responsiveness in ice water at 0 °C (32 °F) and in boiling water at 100 °C (212 °F)  
Surface type: Responsiveness on a metal surface at 0 °C (32 °F) and at 100 °C (212 °F)  
\*2 At -40 °C (-40 °F) and more, the greater of ±1.5 °C (±2.7 °F) and ±0.4 % of the measured value  
\*4 At -40 °C (-40 °F) and more, the greater of ±2.5 °C (±4.5 °F) and ±0.75 % of the measured value

Due to short range ordering, type K thermocouples exhibit increased thermal electromotive force when used to measure temperatures from 250°C to 600°C.

**Discontinued**

**SHEATH TYPE TEMPERATURE PROBE 9472**  
K type, Size of Sheath: φ 2.3 mm (0.09 in) × 150 mm (5.91 in), 1 m (3.28 ft) Cord length

**Discontinuation scheduled**

**SHEATH TYPE TEMPERATURE PROBE 9474**  
K type, Size of Sheath: φ 2.3 mm (0.09 in) × 100 mm (3.94 in), 1 m (3.28 ft) Cord length

**Discontinued**

**SHEATH TYPE TEMPERATURE PROBE 9473**  
K type, Size of Sheath: φ 4.8 mm (0.19 in) × 300 mm (11.81 in), 1 m (3.28 ft) Cord length

**Discontinuation scheduled**

**SHEATH TYPE TEMPERATURE PROBE 9475**  
K type, Size of Sheath: φ 4.8 mm (0.19 in) × 100 mm (3.94 in), 1 m (3.28 ft) Cord length

Due to short range ordering, type K thermocouples exhibit increased thermal electromotive force when used to measure temperatures from 250°C to 600°C.

**Discontinued**

**SHEATH TYPE TEMPERATURE PROBE 9180**  
K type, Size of Sheath: φ 3.2 mm (0.13 in) × 150 mm (5.91 in), 1 m (3.28 ft) Cord length

**Discontinued**

**SURFACE TEMPERATURE PROBE 9181**  
K type, Tip dia.: φ 13 mm (0.51 in), 1 m (3.28 ft) Cord length

**Discontinued**

**SHEATH TYPE TEMPERATURE PROBE 9183**  
K type, Size of Sheath: φ 3.2 mm (0.13 in) × 150 mm (5.91 in), 1 m (3.28 ft) Cord length

**Discontinued**

**SURFACE TEMPERATURE PROBE 9476-50**  
K type, Tip dia.: φ 20 mm (0.79 in), 1 m (3.28 ft) Cord length

**The 9478 is used for the LCR METER IM3533/IM3590** \*These probes are options for the Temperature HiTester 3446-01, 3447-01, both of which are discontinued.

**For the LCR meter IM3533/IM3590** \*For Model 3447-01

**SHEATH TYPE TEMPERATURE PROBE 9478**  
Pt100 type, Tip dia. φ 2.3 mm (0.09 in), 1 m (3.28 ft) Cord length

**For Model 3446-01**

**SHEATH TYPE TEMPERATURE PROBE 9472-50**  
K type, Size of Sheath: φ 2.3 mm (0.09 in) × 150 mm (5.91 in), 1 m (3.28 ft) Cord length

**Discontinued**

**SURFACE TYPE TEMPERATURE PROBE 9476-50**  
K type, Tip dia. φ 20 mm (0.79 in), 1 m (3.28 ft) Cord length

# Digital Multimeters/ Testers

World's Premier Digital Multimeter! Superior Accuracy and High Response, Topped with Safety Terminal Shutters

## DIGITAL MULTIMETER DT4281, DT4282



DT4281

DT4282

- 60000 count, 5-digit display, high-resolution measurements
- $\pm 0.025\%$  DC V basic accuracy, wide 20 Hz to 100 kHz AC V frequency characteristics
- Low-pass filter cuts high harmonics (when measuring inverter fundamental waveforms)
- Includes multiple measurement functions such as DC+ACV, temperature, capacitance, and frequency
- Terminal shutter mechanism (prevents erroneous test lead insertion)
- Measures large currents with optional clamp probe (only for DT4281, which has no 10 A terminal for accident prevention)
- Measure up to 10A with direct input (DT4282 only)
- Dual display lets you check voltage and frequency simultaneously
- Magnetic strap (Optional)
- Rear kickstand
- Store probes at the back of the tester
- Identify excessively high input with a red screen backlight
- Robust design capable of withstanding a drop from a height of 1 m
- USB communications function supports PC measurements (optional)
- Broad -15 (5°F) to 55°C (131°F) operating temperature range

Model No. (Order Code) **DT4281** (Direct and current clamp input terminals)  
**DT4282** (10 A direct input)

Regarding DMM Accuracy Due to the many ranges and functions available in a DMM, only the basic accuracy is indicated for reference. Please refer to the individual catalogs for detailed accuracy information.

### Basic specifications (Accuracy guaranteed for 1 year)

	DT4281	DT4282
DC Voltage range	60.000 mV to 1000.0 V, 6 ranges, Basic accuracy: $\pm 0.025\%$ rdg $\pm 2$ dgt	
AC Voltage* range	60.000 mV to 1000.0 V, 6 ranges, Frequency characteristics: 20 Hz - 100 kHz Basic accuracy 45 - 65 Hz: $\pm 0.2\%$ rdg $\pm 25$ dgt (True RMS, crest factor 3)	
DC + AC Voltage* range	6.0000 V to 1000.0 V, 4 ranges, Frequency characteristics: 20 Hz - 100 kHz Basic accuracy 45 - 65 Hz: $\pm 0.3\%$ rdg $\pm 30$ dgt (True RMS, crest factor 3)	
Resistance range	60.000 $\Omega$ to 600.0 M $\Omega$ , 8 ranges, (Conductance: 600.00 nS, DT4282 only) Basic accuracy: $\pm 0.03\%$ rdg $\pm 2$ dgt	
DC Current range	600.00 $\mu$ A to 600.00 mA, 4 ranges	600.00 $\mu$ A to 10.000 A, 6 ranges
	Basic accuracy: $\pm 0.05\%$ rdg $\pm 5$ dgt	
AC Current* range	600.00 $\mu$ A to 600.00 mA, 4 ranges	600.00 $\mu$ A to 10.000 A, 6 ranges
	Basic accuracy 45 - 65 Hz: $\pm 0.6\%$ rdg $\pm 5$ dgt (True RMS, crest factor 3) Frequency characteristics: 20 Hz - 20 kHz (at 600 $\mu$ A to 600 mA range)	
AC Current* range (use with Clamp on probes)	10.00 A to 1000 A, 7 ranges Add the Clamp on probe accuracy to Basic accuracy 40 - 65 Hz: $\pm 0.6\%$ rdg $\pm 2$ dgt (True RMS, crest factor 3)	N/A
Peak	DC V measurement: Signal width 4 msec or more (single), 1 msec or more (repeated) AC V, DC/AC A measurement: Signal width 1 msec or more (single), 250 $\mu$ sec or more (repeated)	
Capacitance range	1.000 nF to 100.0 mF, 9 ranges, Basic accuracy: $\pm 1.0\%$ rdg $\pm 5$ dgt	
Continuity check	Continuity threshold: 20/50/100/500 $\Omega$ , Response time: 10 ms or more	
Diode test	Open terminal voltage: 4.5 V or less, Testing current 1.2 mA or less, Threshold of forward voltage: 0.15 V to 3 V, seven stages	
Frequency range	AC V, DC+AC V, AC A measurement, at pulse width 1 $\mu$ s or more (50 % duty ratio) 99.999 Hz (0.5 Hz or more) to 500.00 kHz, 5 ranges, $\pm 0.005\%$ rdg $\pm 3$ dgt	
dB conversion	Standard impedance setting (dBm), 4 $\Omega$ to 1200 $\Omega$ , 20 stages Display dB conversion value of AC voltage (dBV)	
Temperature (thermocouples)	K: -40.0 $^{\circ}$ C to 800.0 $^{\circ}$ C (-40.0 $^{\circ}$ F to 1472.0 $^{\circ}$ F) Add accuracy of the Thermocouple probe to main unit accuracy: $\pm 0.5\%$ rdg $\pm 3$ $^{\circ}$ C	
Other functions	Filter function (Remove harmonic noise, use only at 600 VAC, 1000 VAC ranges), Display value hold, Auto hold, Max/Min value display, Sampling select, Relative display, Measurement memory (400 data), Auto-power save, USB communication (option), 4-20 mA % conversion	
Display	Main and Sub displays: 5-digits LCD, max. 60000 digits	
Display refresh rates	5 times/s (Capacitance measurement: 0.05 to 2 times/s, depending on measured value, Temperature: 1 time/s)	
Power supply	LR6 (AA) alkaline batteries $\times 4$ , Continuous use: 100 hours	
Dimensions and mass	93 mm (3.66 in)W $\times$ 197 mm (7.76 in)H $\times$ 53 mm (2.09 in)D, 650 g (22.9 oz) (including test leads holder and batteries)	
Included accessories	Test lead L9207-10 $\times 1$ , Instruction manual $\times 1$ , LR6 alkaline battery $\times 4$	

\* Zero-suppression: For small inputs below the guarantee range, zero is effectively displayed

### Shared options for the DT4280 series, DT4261, DT4250 series

L9207-10 is bundled (DT4280 series, DT4250 series)  
L9300 is bundled (DT4261)

**TEST LEAD L9207-10**  
90 cm (2.95 ft) length

**TEST LEAD L9300**  
95 cm (37.4 in), Integrated cap and protective finger guard

Attach L9207-10 with the cap removed.  
Slide the guard of L9300 and attach as measurement category II.

**CONTACT PIN SET L4933**  
Attaches to the tip of the Test Lead L9207-10/ L9300/ DT4911/ L9206, 60V DC/ 30V AC

**SMALL ALLIGATOR CLIP SET L4934**  
Attaches to the tip of the L4932/ L9207-10/ L9300/ DT4911/ L9206, CAT III 300V, CAT II 600V

For DT4251, 4253 Clamp-on current sensor (Note: Use with the Conversion Adapter 9704, required for connecting Clamp On Probes to DT4281, 4251, 4253)

**CLAMP ON PROBE 9010-50**  
10 to 500 AAC,  $\phi 46$  mm ( $\phi 1.81$  in), 3 m (9.84 ft) length

**CLAMP ON PROBE 9018-50**  
Wide-band type, 10 to 500 AAC,  $\phi 46$  mm ( $\phi 1.81$  in), 3 m (9.84 ft) length

**CLAMP ON PROBE 9132-50**  
20 to 1000 AAC,  $\phi 55$  mm ( $\phi 2.17$  in) or 80  $\times$  20 mm (3.15  $\times$  0.79 in), 3 m (9.84 ft) length

**CONVERSION ADAPTER 9704**  
Receiving end: Female BNC; Output end: Male banana-plug \*Not compatible with older generation MEMORY HICORDERs with banana input terminals

Options for the L4930, Test Pin Set L4932 is required when using the Small Alligator Clip Set L4934

**CONNECTION CABLE SET L4930**  
12 m (3.94 ft) length, CAT IV 600V, CAT III 1000V

**EXTENSION CABLE SET L4931**  
Expands the length of the L4930/L4940, 1.5 m (4.92 ft) length

**TEST PIN SET L4932**  
Attaches to the tip of the L4930/L4940, CAT IV 600V, CAT III 1000V

**SMALL ALLIGATOR CLIP SET L4934**  
Attaches to the tip of the L4932, L9207-10/DT4911, L9206, CAT III 300V, CAT II 600V

**ALLIGATOR CLIP SET L4935**  
Attaches to the tip of the L4930/L4940, CAT IV 600V, CAT III 1000V

**BUS BAR CLIP SET L4936**  
Attaches to the tip of the L4930/L4940, CAT III 600V

**MAGNETIC ADAPTER SET L4937**  
Attaches to the tip of the L4930/L4940, CAT III 1000V

**MAGNETIC ADAPTER 9804**  
Attaches to the tip of voltage cord,  $\phi 11$  mm (0.43 in), compatible M6 pan screws

**TEST PIN SET L4938**  
Attaches to the tip of the L4930/L4940, CAT III 600V

**BREAKER PIN SET L4939**  
Attaches to the tip of the L4930/L4940, CAT III 600V

**GRABBER CLIP L9243**  
Attaches to the tip of the L4930/L4940, CAT II 1000 V, 185 mm (7.28 in) length

Temperature measurement

**THERMOCOUPLES(K) DT4910**  
K type, tip exposed, 0.3 mm (0.01 in) diameter, 80 cm (2.62 ft) length, -40 to 260  $^{\circ}$ C (-40 to 500  $^{\circ}$ F)

Other options

**COMMUNICATION PACKAGE(USB) DT4900-01**  
Compatible to Windows 10

**MAGNETIC STRAP Z5020**  
Extra strength

**CARRYING CASE C0202**

**CARRYING CASE C0207**  
Bag type

Not compatible with DT 4281, DT4282

**CARRYING CASE C0201**

DMM Testers

### Ideal for checking ripple voltage in DC supply systems

**DC + ACV**

Peak measurement function & DC+AC voltage measurement  
Capture ripple voltage component on direct current signals.

Input waveform

DC+AC measurement 100 V

-PEAK measurement 85.9 V

+PEAK measurement 114.1 V

### Optimized for inverter system measurements

**LPF 1kHz**

Low-pass filter cuts harmonic waveform components

The (1 kHz cutoff) low-pass filter function cuts high harmonic components when measuring the secondary output voltage of an inverter.

**Filter off**

Typical waveform + harmonic components

Display: 23.15 V, 48508 Hz

**Filter on**

Typical waveform component

Display: 20230 V, 49973 Hz

Refer to the detailed catalog

## Analyzing Issues in the Field and Dramatically Improving Work Efficiency

### DIGITAL MULTIMETER DT4261



DT4261



CAT IV 600 V  
CAT III 1000 V



When Z3210 is installed

- Capable of measuring up to cat III 2000 V with DC HIGH VOLTAGE PROBE P2000\*  
Dramatically improves the safety of maintenance of large-scale solar power generation facilities
- \*1: 2000 V is supported only when the optional DC HIGH VOLTAGE PROBE P2000 is used.
- Helping personnel analyze issues in the field
- Stop worrying about losing test lead caps
- Boost work efficiency with digitalization (Excel® Direct Input Function)
- Excellent dust and water resistance (compliant with the IP54 international standard)
- Ensuring safety by preventing erroneous test lead insertion (terminal shutters)

Model No. (Order Code) **DT4261** (Wireless Adapter Z3210 not included)  
**DT4261-90** (Bundled with the Wireless Adapter Z3210)

■ Data can be downloaded to tablets and smartphones using HioKI's dedicated apps available from the Google Play or App Store. Search for "HIOKI" and download the "GENNECT Cross" app.



\*Android, Google Play and the Google Play logo are trademarks of Google Inc.  
\*iOS is a registered trademark of Cisco Technology, Inc. and/or its affiliates in the United States and certain other countries.  
\*iPhone, iPad, iPad mini, iPad Pro and iPod touch are trademarks of Apple Inc.  
\*Apple and the Apple logo are trademarks of Apple Inc. App Store is a service mark of Apple Inc.  
\*Microsoft, Windows, Windows Vista, and Excel are either registered trademarks or trademarks of Microsoft Corporation in the United States and/or other countries.  
\*Company names and Product names appearing in this catalog are trademarks or registered trademarks of various companies.  
\*The Bluetooth® word mark and logos are registered trademarks owned by Bluetooth SIG, Inc. and any use of such marks by HIOKI E.E. CORPORATION is under license.  
\*For the latest information about countries and regions where wireless operation is currently supported, please visit the HioKI website.

Regarding DMM Accuracy	Due to the many ranges and functions available in a DMM, only the basic accuracy is indicated for reference. Please refer to the individual catalogs for detailed accuracy information.
■ Basic specifications (Accuracy guaranteed for 1 year)	
DC Voltage range	600.0 mV to 1000 V, 5 ranges, Basic accuracy: $\pm 0.15\%$ rdg. $\pm 2$ dgt.
AC Voltage range	6.000 V to 1000 V, 4 ranges, Frequency characteristics: 40 Hz to 1 kHz Basic accuracy 40 Hz - 500 Hz: $\pm 0.9\%$ rdg. $\pm 3$ dgt. (True RMS, crest factor 3 or less)
DC + AC Voltage range	6.000 V to 1000 V, 4 ranges, Frequency characteristics: DC, 40 Hz to 1 kHz Basic accuracy DC, 40 Hz - 500 Hz: $\pm 1.0\%$ rdg. $\pm 13$ dgt. (True RMS, crest factor 3 or less)
LoZ V	600.0 V, 1 range, Frequency characteristics: DC, 40 Hz to 1 kHz Basic accuracy DC, 40 Hz - 500 Hz: $\pm 1.0\%$ rdg. $\pm 13$ dgt. (True RMS, crest factor 3 or less)
Resistance range	600.0 $\Omega$ to 60.00 M $\Omega$ , 6 ranges, Basic accuracy: $\pm 0.7\%$ rdg. $\pm 3$ dgt.
DC Current range	600.0 mA to 10.00 A, 3 ranges Basic accuracy: $\pm 0.5\%$ rdg. $\pm 3$ dgt.
AC Current range	600.0 mA to 10.00 A, 3 ranges Basic accuracy 40 Hz - 500 Hz: $\pm 1.4\%$ rdg. $\pm 3$ dgt. (True RMS, crest factor 3 or less) Frequency characteristics: 40 Hz to 1 kHz
AC Current range (use with Clamp on probes)	10.00 A to 1000 A, 7 ranges Basic accuracy 40 Hz - 500 Hz: Add the Clamp on probe accuracy to $\pm 0.9\%$ rdg. $\pm 3$ dgt. (True RMS, crest factor 3 or less)
Capacitance range	1.000 $\mu$ F to 10.00 mF, 5 ranges, Basic accuracy: $\pm 1.9\%$ rdg. $\pm 5$ dgt.
Continuity Check	Continuity threshold ON : 25 $\Omega$ , Continuity threshold OFF : 245 $\Omega$ , Response time: 0.5 ms or more
Diode test	Open terminal voltage: 2.0 V or less, Testing current: 0.2 mA or less, Threshold of forward voltage: 0.15 V to 1.8V
Voltage frequency range	99.99 Hz to 99.99 kHz, 4 ranges (Limited by minimum sensitivity voltage) Basic accuracy: $\pm 0.1\%$ rdg. $\pm 1$ dgt.
Current frequency range	99.99 Hz to 9.999 kHz, 3 ranges (Limited by minimum sensitivity current) Basic accuracy: $\pm 0.1\%$ rdg. $\pm 1$ dgt.
Other functions	Mis-insertion prevention shutters, fuse check function, user setting retention function, filter function, zero-adjustment, display value hold, auto hold, MAX/MIN value display, PEAK value display, auto-power save, USB communication (when optional Communication Package DT4900-01 is installed), wireless communication (when optional Wireless Adapter Z3210 is installed)
Display	Main and sub displays: 4-digits LCD, max. 6000 digits (excluding frequency measurement), bar-graph
Display refresh rates	5 times/s (Capacitance measurement: 0.05 to 5 times/s, depending on measured value, Frequency: 1 to 2 times/s)
Power supply	LR6 (AA) alkaline batteries $\times$ 3, Continuous operating time: 130 hr. (without Z3210 installed), 70 hr. (with Z3210 installed and using wireless communications)
Dimensions and mass	87 mm (3.43 in.) W $\times$ 185 mm (7.28 in.) H $\times$ 47 mm (1.85 in.) D, 480 g (16.9 oz.) (with test leads holder and batteries)
Included accessories	Test Lead L9300 $\times$ 1, Instruction Manual $\times$ 1, LR6 (AA) alkaline battery $\times$ 3, Operating Precautions $\times$ 1

#### Option for DT4261

L4943 is bundled with P2000



DC HIGH VOLTAGE PROBE P2000  
CAT III 2000 V  
CONNECTION CABLE SET L4943 is bundled



CONNECTION CABLE SET L4943  
Bundled with P2000,  
Cable length: 65 mm (2.56 in.)

When Z3210 is installed



GENNECT Cross  
SF4071, SF4072  
Mobile app for iOS, Android

#### Bluetooth® communication with Z3210 attached to DT4261

Refer to the detailed catalog

Install the Wireless Adapter Z3210 to the DT4261 to enable Bluetooth® communications.  
With the Z3210, you can transfer data directly to an Excel® file or pair the instrument with GENNECT Cross.

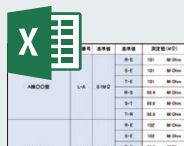

Z3210  
For more details



Attach to enable Bluetooth® wireless technology

Transport to the Excel® file

Transport to GENNECT Cross

# Digital Multimeters/ Testers

## Standard DMM that Delivers Top Safety and Reliability - General Purpose Testers with Rich Measurement Functions

### DIGITAL MULTIMETER DT4252, DT4256



DT4252



DT4256



- $\pm 0.3\%$  DC V basic accuracy, wide 40 Hz to 1 kHz AC V frequency characteristics
- Measure up to 10A with direct input
- Dual display lets you check voltage and frequency simultaneously
- Low-pass filter cuts high harmonics (when measuring inverter fundamental waveforms)
- USB communications function supports PC measurements (optional)
- Broad -25 (-13°F) to 65°C (149°F) operating temperature range (DT4256)

Model No. (Order Code)	<b>DT4252</b>	(10 A direct input)
	<b>DT4256</b>	(Multi-functional model, with 10 A direct input)

**Regarding DMM Accuracy** Due to the many ranges and functions available in a DMM, only the basic accuracy is indicated for reference. Please refer to the individual catalogs for detailed accuracy information.

#### Basic specifications (Accuracy guaranteed for 1 year)

	DT4252	DT4256
DC Voltage range	600.0 mV to 1000 V, 5 ranges	
	Basic accuracy: $\pm 0.3\%$ rdg $\pm 5$ dgt	Basic accuracy: $\pm 0.3\%$ rdg $\pm 3$ dgt
AC Voltage range	6.000 V to 1000 V, 4 ranges, Frequency characteristics: 40 Hz to 1 kHz	
	Basic accuracy 40 - 500 Hz: $\pm 0.9\%$ rdg $\pm 3$ dgt (True RMS, crest factor 3)	
AUTO AC/DCV	N/A	Yes
Resistance range	600.0 $\Omega$ to 60.00 M $\Omega$ , 6 ranges, Basic accuracy: $\pm 0.7\%$ rdg $\pm 5$ dgt	600.0 $\Omega$ to 60.00 M $\Omega$ , 6 ranges, Basic accuracy: $\pm 0.7\%$ rdg $\pm 3$ dgt
DC Current range	6.000 A / 10.00 A, 2 ranges, Basic accuracy: $\pm 0.9\%$ rdg $\pm 5$ dgt	600.0 mA to 10.00 A, 4 ranges, Basic accuracy: $\pm 0.9\%$ rdg $\pm 3$ dgt
AC Current range	6.000 A / 10.00 A, 2 ranges, Basic accuracy 40 - 500 Hz: $\pm 1.4\%$ rdg $\pm 3$ dgt (True RMS, crest factor 3, 40 Hz to 1 kHz)	600.0 mA to 10.00 A, 3 ranges, Basic accuracy 40 - 500 Hz: $\pm 1.4\%$ rdg $\pm 3$ dgt (True RMS, crest factor 3, 40 Hz to 1 kHz)
AC Current range (use with Clamp on probes)	N/A	10.00 A to 1000 A, 7 ranges, Add the Clamp on probe accuracy to basic accuracy 40 - 1 kHz: $\pm 0.9\%$ rdg $\pm 3$ dgt (True RMS, crest factor 3)
Voltage detection (50/60 Hz)	N/A	Hi: AC40 V to 600 V, Lo: AC80 V to 600 V
Capacitance range	1.000 $\mu$ F to 10.00 mF, 5 ranges, Basic accuracy: $\pm 1.9\%$ rdg $\pm 5$ dgt	
Frequency range	99.99 Hz (5 Hz or more) to 99.99 kHz, 4 ranges (limited by the minimum detectable voltage and current), Basic accuracy: $\pm 0.1\%$ rdg $\pm 1$ dgt	
Continuity check	Continuity threshold [ON]: 25 $\Omega$ or less (Indicate buzzer sound, red LED), [OFF]: 245 $\Omega$ or more, Response time: 0.5 ms or more	
Diode test	Open terminal voltage: 5.0 V or less, Testing current 0.5 mA or less, Threshold of forward voltage: 0.15 V to 1.5 V	
Other functions	Filter function, Display value hold, Auto hold, Max/Min/Average value display, Relative display, Auto-power save, USB communication (option)	
Display	Main and Sub displays: 4-digits LCD, max. 6000 digits, bar graph	
Display refresh rates	5 times/s (Capacitance measurement: 0.05 to 5 times/s, depending on measured value, Frequency: 1 to 2 time/s, Temperature: 1 time/s)	
Power supply	LR03 alkaline batteries $\times 4$ , Continuous use: 130 hours (backlight OFF)	
Dimensions and mass	84 mm (3.31 in)W $\times$ 174 mm (6.85 in)H $\times$ 52 mm (2.05 in)D, 390 g (13.8 oz) (including batteries and holster)	
Included accessories	Test lead L9207-10 $\times 1$ , Holster $\times 1$ , Instruction manual $\times 1$ , LR03 alkaline battery $\times 4$	

## Standard DMM that Delivers Top Safety and Reliability - Application-Specific Testers to Meet Your Needs

### DIGITAL MULTIMETER DT4253, DT4255



DT4253



DT4255



- Ideal for measuring currents ranging from instrumentation signals (4 to 20 mA) to flame currents ( $\mu$ A) with built in high-sensitivity current ranges (DT4253)
- Prevents short-circuit accidents with a fast-blow fuse and current-limiting resistor (DT4255)
- Prevents accidents with clamp-on sensor-based current measurement (DT4255)
- Voltage detection function (DT4255)
- Low-pass filter cuts high harmonics (when measuring inverter fundamental waveforms)
- Broad -25°C (-13°F) to 65°C (149°F) operating temperature range (DT4255)
- Dual display lets you check voltage and frequency simultaneously

\*1 Your instrument can be used to measure voltages in excess of 1000 V DC if and only if both of the following conditions are satisfied: 1. The circuit under measurement is isolated from the commercial power grid. 2. The circuit under measurement is isolated from ground.

Model No. (Order Code)	<b>DT4253</b>	(With mA DC, temperature)
	<b>DT4255</b>	(With fused measurement terminals)

**Regarding DMM Accuracy** Due to the many ranges and functions available in a DMM, only the basic accuracy is indicated for reference. Please refer to the individual catalogs for detailed accuracy information.

#### Basic specifications (Accuracy guaranteed for 1 year)

	DT4253	DT4255
DC Voltage range	600.0 mV to 1000 V	
	5 ranges, Basic accuracy: $\pm 0.3\%$ rdg $\pm 5$ dgt	5 ranges, Basic accuracy: $\pm 0.3\%$ rdg $\pm 3$ dgt
AC Voltage range	6.000 V to 1000 V, 4 ranges, Frequency characteristics: 40 Hz to 1 kHz	
	Basic accuracy 40 - 500 Hz: $\pm 0.9\%$ rdg $\pm 3$ dgt (True RMS, crest factor 3)	
AUTO AC/DCV	Yes	
Resistance range	600.0 $\Omega$ to 60.00 M $\Omega$ , 6 ranges, Basic accuracy: $\pm 0.7\%$ rdg $\pm 5$ dgt	600.0 $\Omega$ to 60.00 M $\Omega$ , 6 ranges, Basic accuracy: $\pm 0.7\%$ rdg $\pm 3$ dgt
DC Current range	60.00 $\mu$ A to 60.00 mA, 4 ranges, Basic accuracy: $\pm 0.8\%$ rdg $\pm 5$ dgt	N/A
From 4 to 20mA Percentage conversion display	Yes	N/A
AC Current range (use with Clamp on probes)	10.00 A to 1000 A, 7 ranges, Add the Clamp on probe accuracy to basic accuracy 40 - 1 kHz: $\pm 0.9\%$ rdg $\pm 3$ dgt (True RMS, crest factor 3)	
Temperature (thermocouples)	K: -40.0 to 400.0 $^{\circ}$ C, Add the Temperature probe accuracy to basic accuracy: $\pm 0.5\%$ rdg $\pm 2$ $^{\circ}$ C	N/A
Voltage detection	N/A	
Capacitance range	1.000 $\mu$ F to 10.00 mF, 5 ranges, Basic accuracy: $\pm 1.9\%$ rdg $\pm 5$ dgt	
Frequency range	99.99 Hz to 99.99 kHz, 4 ranges (limited by the minimum detectable voltage), Basic accuracy: $\pm 0.1\%$ rdg $\pm 1$ dgt	
Continuity check	Continuity threshold [ON]: 25 $\Omega$ or less, [OFF]: 245 $\Omega$ or more, Response time: 0.5 ms or more	
Diode test	Open terminal voltage: 5.0 V or less, Testing current 0.5 mA or less, Threshold of forward voltage: 0.15 V to 1.5 V	
Other functions	Filter function, Display value hold, Auto hold, Max/Min/Average value display, Relative display, Auto-power save, USB communication (option)	
Display	Main and Sub displays: 4-digits LCD, max. 6000 digits, bar graph	
Display refresh rates	5 times/s (Capacitance measurement: 0.05 to 5 times/s, depending on measured value, Frequency: 1 to 2 time/s)	
Power supply	LR03 alkaline batteries $\times 4$ , Continuous use: 130 hours (backlight OFF)	
Dimensions and mass	84 mm (3.31 in)W $\times$ 174 mm (6.85 in)H $\times$ 52 mm (2.05 in)D, 390 g (13.8 oz) (including batteries and holster)	
Included accessories	Test lead L9207-10 $\times 1$ , Holster $\times 1$ , Instruction manual $\times 1$ , LR03 alkaline battery $\times 4$	

\*1 Your instrument can be used to measure voltages in excess of 1000 V DC if and only if both of the following conditions are satisfied: 1. The circuit under measurement is isolated from the commercial power grid. 2. The circuit under measurement is isolated from ground.

#### Key Point

#### Absolute prevention of short-circuit accidents (DT4255)

In the event of erroneous operation, a protective circuit functions to prevent a short-circuit. A current-limiting resistor limits the short-circuit current if damage to the tester's circuitry results in a short-circuit condition, and a fast-blow fuse quickly disconnects the circuit to ensure safety.

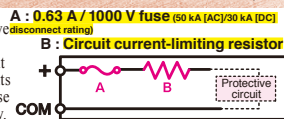

## Premier Pocket DMM with CAT IV 300V/ CAT III 600V Safety

### DIGITAL MULTIMETER DT4221, DT4222



- Achieving a high level of safety in a compact body and lightweight design
- Resistance and diode testing functions omitted by design in pursuit of added safety (DT4221)
- Voltage detection function (DT4221)
- Resistance, Capacitance measurement and diode testing (DT4222)
- Robust design capable of withstanding a drop from a height of 1 m
- Test leads conveniently wrap around the back
- $\pm 0.5\%$  DC V basic accuracy, wide 40 Hz to 1 kHz AC V frequency characteristics
- Low-pass filter cuts high harmonics (when measuring inverter fundamental waveforms)
- Broad -10 (14°F) to 50°C (122°F) operating temperature range
- Display backlight

Model No. (Order Code) **DT4221** (V measurement only, for electrical work)  
**DT4222** (With C/R measurement, for general use)

**Regarding DMM Accuracy** Due to the many ranges and functions available in a DMM, only the basic accuracy is indicated for reference. Please refer to the individual catalogs for detailed accuracy information.

#### Basic specifications (Accuracy guaranteed for 1 year)

	DT4221	DT4222
DC Voltage range	600.0 mV to 600.0 V, 4 ranges, Basic accuracy: $\pm 0.5\%$ rdg $\pm 5$ dgt	
AC Voltage range	6.000 V to 600.0 V, 3 ranges, Frequency characteristics: 40 Hz - 1 kHz Basic accuracy 40 - 500 Hz: $\pm 1.0\%$ rdg $\pm 3$ dgt (True RMS, crest factor 3)	
Resistance range	N/A	600.0 $\Omega$ to 60.00 M $\Omega$ , 6 ranges Basic accuracy: $\pm 0.9\%$ rdg $\pm 5$ dgt
Capacitance range	N/A	1.000 $\mu$ F to 10.00 mF, 5 ranges Basic accuracy: $\pm 1.9\%$ rdg $\pm 5$ dgt
Frequency range	AC V measurement: 99.99 Hz (5 Hz or more) to 9.999 kHz, 3 ranges Basic accuracy: $\pm 0.1\%$ rdg $\pm 2$ dgt	
Continuity check	Continuity threshold [ON]: 25 $\Omega$ or less (buzzer sound), [OFF]: 245 $\Omega$ or more Response time: 0.5 ms or more	
Diode test	N/A	Open terminal voltage: 2.5 V or less, Testing current 0.5 mA or less, Threshold of forward voltage: 0.15 V to 1.5 V
Voltage detection	80 V to 600 V AC	N/A
Other functions	Filter function, Display value hold, Relative display, Auto-power save	
Display	Main and Sub displays: 4-digits LCD, max. 6000 digits, bar graph	
Display refresh rates	5 times/s (Capacitance measurement: 0.05 to 5 times/s, depending on measured value, Frequency: 1 to 2 time/s)	
Power supply	LR03 alkaline batteries $\times 1$ , Continuous use: 40 hours (backlight OFF)	
Dimensions and mass	72 mm (2.83 in)W $\times$ 149 mm (5.87 in)H $\times$ 38 mm (1.50 in)D, 190 g (6.7 oz) (including batteries and holster)	
Included accessories	Test lead DT4911 $\times 1$ , Holster $\times 1$ , Instruction manual $\times 1$ , LR03 alkaline battery $\times 1$	

## Proprietary Protection Function Against Accidental Voltage Input Prevents Power Failure and Fires

### DIGITAL MULTIMETER DT4223, DT4224



- Achieving a high level of safety in a compact body and lightweight design
- Circuit breaker false trip prevention function helps avoid accidents resulting from breakers that mistakenly trip due to incorrect input
- Resistance measurement and voltage detection function (DT4223)
- More convenient function: Resistance, Capacitance measurement and diode testing (DT4224)
- Robust design capable of withstanding a drop from a height of 1 m
- Test leads conveniently wrap around the back
- $\pm 0.5\%$  DC V basic accuracy, wide 40 Hz to 1 kHz AC V frequency characteristics
- Low-pass filter cuts high harmonics (when measuring inverter fundamental waveforms)
- Broad -10 (14°F) to 65°C (149°F) operating temperature range
- Display backlight

Model No. (Order Code) **DT4223** (With resistance measurement, for electrical work)  
**DT4224** (With C/R measurement, for general use)

**Regarding DMM Accuracy** Due to the many ranges and functions available in a DMM, only the basic accuracy is indicated for reference. Please refer to the individual catalogs for detailed accuracy information.

#### Basic specifications (Accuracy guaranteed for 1 year)

	DT4223	DT4224
DC Voltage range	600.0 mV to 600.0 V, 4 ranges, Basic accuracy: $\pm 0.5\%$ rdg $\pm 5$ dgt	
AC Voltage range	6.000 V to 600.0 V, 3 ranges, Frequency characteristics: 40 Hz - 1 kHz Basic accuracy 40 - 500 Hz: $\pm 1.0\%$ rdg $\pm 3$ dgt (True RMS, crest factor 3)	
Resistance range	600.0 $\Omega$ to 60.00 M $\Omega$ , 6 ranges Basic accuracy: $\pm 0.9\%$ rdg $\pm 5$ dgt	
Capacitance range	N/A	1.000 $\mu$ F to 10.00 mF, 5 ranges, Basic accuracy: $\pm 1.9\%$ rdg $\pm 5$ dgt
Frequency range	AC V measurement: 99.99 Hz (5 Hz or more) to 9.999 kHz, 3 ranges Basic accuracy: $\pm 0.1\%$ rdg $\pm 2$ dgt	
Continuity check	Continuity threshold [ON]: 25 $\Omega$ or less (buzzer sound), [OFF]: 245 $\Omega$ or more Response time: 0.5 ms or more	
Diode test	N/A	Open terminal voltage: 2.5 V or less, Testing current 0.5 mA or less, Threshold of forward voltage: 0.15 V to 1.5 V
Voltage detection	80 V to 600 V AC	N/A
Other functions	Circuit breaker false trip prevention function, Filter function, Display value hold, Relative display, Auto-power save	
Display	Main and Sub displays: 4-digits LCD, max. 6000 digits, bar graph	
Display refresh rates	5 times/s (Capacitance measurement: 0.05 to 5 times/s, depending on measured value, Frequency: 1 to 2 time/s)	
Power supply	LR03 alkaline batteries $\times 1$ , Continuous use: 35 hours (backlight OFF)	
Dimensions and mass	72 mm (2.83 in)W $\times$ 149 mm (5.87 in)H $\times$ 38 mm (1.50 in)D, 190 g (6.7 oz) (including batteries and holster)	
Included accessories	Test lead DT4911 $\times 1$ , Holster $\times 1$ , Instruction manual $\times 1$ , LR03 alkaline battery $\times 1$	

### Shared options for the DT4220 series

Test leads	<p>DT4911 is bundled</p> <p><b>TEST LEAD DT4911</b> CAT IV 300V, CAT III 600V, 54cm (1.77ft) length</p>	<p>Attach DT4911 with the cap removed.</p> <p><b>CONTACT PIN SET L4933</b> Attaches to the tip of the Test Lead L9207-10/ L9300/DT4911/L9206, 60V DC/30V AC</p>	<p><b>SMALL ALLIGATOR CLIP SET L4934</b> Attaches to the tip of the L4932/L9207-10/L9300/ DT4911/L9206, CAT III 300V, CAT II 600V</p>
------------	---	---	---

Other options	<p><b>MAGNETIC STRAP Z502</b> Extra strength</p>	<p><b>MAGNETIC STRAP Z5004</b></p>	<p><b>CARRYING CASE C0200</b></p>
---------------	--	------------------------------------	-----------------------------------

## Pencil-type DMM with LED Light

### PENCIL HiTESTER 3246-60



Not CE Marked  
CAT IV 300 V  
CAT III 600 V

3 Year  
Warranty

Removable  
test pin sleeves  
prevent short-  
circuits

- Test lead and main unit in a single body
- Overload protection to 600 V at resistance or continuity functions
- LED light brightly illuminates test points

Model No. (Order Code) **3246-60**

**Regarding DMM Accuracy** Due to the many ranges and functions available in a DMM, only the basic accuracy is indicated for reference. Please refer to the individual catalogs for detailed accuracy information.

**Basic specifications** (Accuracy guaranteed for 1 year)

DC Voltage range	419.9 mV to 600 V, 5 ranges, Basic accuracy: $\pm 1.3\% \text{ rdg} \pm 4 \text{ dgt}$
AC Voltage range	4.199 V to 600 V, 4 ranges, Basic accuracy 50 - 500 Hz : $\pm 2.3\% \text{ rdg} \pm 8 \text{ dgt}$ (Average rectified)
Resistance range	419.9 $\Omega$ to 41.99 M $\Omega$ , 6 ranges, Basic accuracy: $\pm 2.0\% \text{ rdg} \pm 4 \text{ dgt}$
Continuity buzzer	Detection level 50 $\Omega \pm 40 \Omega$
Diode check	Judges the right direction only, Open terminal voltage: 3.4 V or less, Testing current: 800 $\mu\text{A}$ or less
Auto power save	Available (cancel selectable)
Display	Digital LCD, max. 4199 digits
Sampling rate	2.5 times/sec
Power supply	Coin type lithium battery (CR2032) $\times 1$ , Continuous use: 150 hours (at DC V function), 30 hours (with light turned on for 10 seconds and off for 20 seconds per cycle and in DC V function)
Dimensions and mass	30 mm (1.18 in)W $\times$ 182 mm (7.17 in)H $\times$ 26.5 mm (1.04 in)D, 80 g (2.8 oz)
Included accessories	Instruction manual $\times 1$ , Coin type lithium battery (CR2032) $\times 1$ (for trial purposes only), Sleeves (Red/ Black each 1)

## Compact ! Palm Size Body, Less Than 1cm Thin!

### CARD HiTESTER 3244-60



CE  
CAT III 300 V  
CAT II 600 V

3 Year  
Warranty

Removable  
test pin sleeves  
prevent short-  
circuits

Rugged external case C0204 protects the DMM. Standard accessory.

- Better contact test leads with 15 mm gold-plated tip pin
- Only 9.5 mm(0.37 in) thick and 60 g(2.1 oz) in weight
- Full auto-ranging function and automatic power saving function
- Overload protection to 500 V at resistance or continuity functions

Model No. (Order Code) **3244-60**

**Regarding DMM Accuracy** Due to the many ranges and functions available in a DMM, only the basic accuracy is indicated for reference. Please refer to the individual catalogs for detailed accuracy information.

**Basic specifications** (Accuracy guaranteed for 1 year)

DC Voltage range	419.9 mV to 500 V, 5 ranges, Basic accuracy: $\pm 0.7\% \text{ rdg} \pm 4 \text{ dgt}$
AC Voltage range	4.199 V to 500 V, 4 ranges, Basic accuracy 50 - 500 Hz : $\pm 2.3\% \text{ rdg} \pm 8 \text{ dgt}$ (Average rectified)
Resistance range	419.9 $\Omega$ to 41.99 M $\Omega$ , 6 ranges, Basic accuracy: $\pm 2.0\% \text{ rdg} \pm 4 \text{ dgt}$
Continuity buzzer	Detection level 50 $\Omega \pm 40 \Omega$ , Diode check: Not available
Auto power save	Available (cancel selectable)
Display	Digital LCD, max. 4199 digits
Sampling rate	2.5 times/sec
Power supply	Coin type lithium battery (CR2032) $\times 1$ , Continuous use: 150 hours
Dimensions and mass	55 mm (2.17 in)W $\times$ 109 mm (4.29 in)H $\times$ 9.5 mm (0.37 in)D, 60 g (2.1 oz)
Included accessories	Instruction manual $\times 1$ , Carrying case $\times 1$ , Coin type lithium battery (CR2032) $\times 1$ (for trial purposes only), Sleeves (Red/ Black each 1)

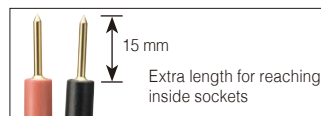

\*When used in CAT III environments, test pin sleeves are required.



## Basic Analog Tester (20 kilohm/V)

### HiTESTER 3030-10

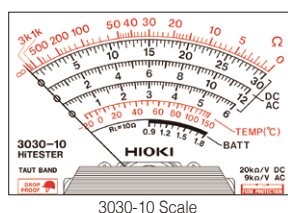

Not CE Marked  
CAT III 600 V

Drop-  
proof

3 Year  
Warranty

- Drop proof design withstands drop onto a concrete floor from a height of 1 meter
- LED check, Battery check support

Model No. (Order Code) **3030-10**

**Basic specifications** (Accuracy guaranteed for 1 year)

DC Voltage range	0.3 V (16.7 k $\Omega$ /V), 3/12/30/120/300/600 V (20 k $\Omega$ /V) Accuracy: $\pm 2.5\% \text{ f.s.}$ Max. rated voltage: 600 V
AC Voltage range	12 V (9 k $\Omega$ /V) Accuracy: $\pm 4\% \text{ f.s.}$ 30/120/300/600 V (9 k $\Omega$ /V) Accuracy: $\pm 2.5\% \text{ f.s.}$ Average rectifier effective value, Max. rated voltage: 600 V
DC Current range	60 $\mu\text{A}$ /30 m/300 mA (300 mV internal voltage drop) Accuracy: $\pm 3\% \text{ f.s.}$
Resistance range	0 to 3 k $\Omega$ (center scale 30 $\Omega$ ), R $\times 1$ , R $\times 10$ , R $\times 100$ , R $\times 1 \text{ k}$ Accuracy: $\pm 3\% \text{ of scale length}$
Battery check	0.9 to 1.8 V, load resistance 10 $\Omega$ , Accuracy: $\pm 6\% \text{ f.s.}$
Temperature scale	Note: The 3030-10 includes a temperature measurement scale, but because the optional Thermister Temperature Probe 9021-01 has been discontinued, the scale is not available for new customers.
Power supply	For resistance measurement range, R6P (AA) $\times 2$ batteries
Dimensions and mass	95 mm (3.74 in)W $\times$ 141 mm (5.55 in)H $\times$ 39 mm (1.54 in)D, 280 g (9.9 oz)
Included accessories	Test lead L9207-30 $\times 1$ , Spare fuse $\times 1$ , R6P (AA) manganese batteries $\times 2$ , Instruction manual $\times 1$ , Carrying case 9390 $\times 1$

\*The L9207-30 and the 9390 are bundled



DMM Testers

## Quick Response Comparator Offering Reading Stability in High-speed Digital Format

### INSULATION TESTER IR4057-50



CAT III 600 V



When Z3210 is installed

#### Basic specifications (Accuracy guaranteed for 1 year)

Rated output voltage	50 V DC	125 V DC	250 V DC	500 V DC	1000 V DC
Effective maximum indicated value	100 MΩ	250 MΩ	500 MΩ	2000 MΩ	4000 MΩ
Accuracy 1st effective measuring range MΩ	±2 % rdg ±2 dgt 0.200 - 10.00	±2 % rdg ±2 dgt 0.200 - 25.0	±2 % rdg ±2 dgt 0.200 - 50.0	±2 % rdg ±2 dgt 0.200 - 500	±2 % rdg ±2 dgt 0.200 - 1000
Lower limit resistance	0.05 MΩ	0.125 MΩ	0.25 MΩ	0.5 MΩ	1 MΩ
Overload protection	600 V AC (10s)				660 V AC (10s)
DC voltage range	4.2 V (0.001 V resolution) to 600 V (1 V resolution), 4 ranges, Accuracy: ±1.3% rdg ±4 dgt, Input resistance: 100 kΩ or higher				
AC voltage range	420 V (0.1 V resolution) / 600 V (1 V resolution), 2 ranges, 50/60 Hz, Accuracy: ±2.3% rdg ±8 dgt, Input resistance: 100 kΩ or higher, Average rectifier				
Low resistance range	For checking the continuity of ground wiring, 10 Ω (0.01 Ω resolution) to 1000 Ω (1 Ω resolution), 3 ranges, Basic accuracy: ±3 % rdg ±2 dgt, testing current 200 mA or more (at 6 Ω or less)				
Display	Semi-transmissive FSTN LCD with back lighting, bar-graph indicator				
Response time	Approx. 0.3 second for PASS/FAIL decision (based on in-house testing)				
Other functions	Indicate MΩ measurement value after a lapse of one minute, Live circuit indicator, Automatic electric discharge, Automatic DC/AC detection, Comparator, Drop proof, Auto power save				
Power supply	LR6 (AA) alkaline batteries × 4, Continuous use: 20 hours (based on in-house testing) Number of measurements: 1000 times (at 5 s ON, 25 s OFF cycle, insulation measurement of lower limit resistance value to maintain nominal output voltage)				
Dimensions and mass	159 mm (6.26 in) W × 177 mm (6.97 in) H × 53 mm (2.09 in) D, 640 g (22.6 oz) (including batteries, excluding test leads)				
Included accessories	Connection cable L4930 ×1, Alligator clip set L4935 ×1, Test pin set L4938 ×1, Neck strap ×1, Instruction manual ×1, LR6 (AA) alkaline batteries ×4				

- Easily transfer measurement data to your smartphone or tablet by using our free app GENNECT Cross or to an Excel® file. (Wireless Adapter Z3210 is necessary)
- 5-range testing voltage of 50 V/100 MΩ to 1000 V/4000 MΩ
- Digital bar graph
- Stable & high-speed digital readings, 0.3 second response time for PASS/ FAIL decisions
- Drop proof onto concrete from 1m (3.28 feet)
- Bright LED, luminous LCD, test lead with bright LED lamp to illuminate near hand (Option L9788-11 or L9788-10)
- Continuity check via 200 mA testing
- Built in AC/DC voltage meter, useful for testing solar power generation systems and electric vehicles

Model No. (Order Code) **IR4057-50** (Wireless Adapter Z3210 not included)  
**IR4057-90** (Bundled with the Wireless Adapter Z3210)

■ Data can be downloaded to tablets and smartphones using HioKI's dedicated apps available from the Google Play or App Store. Search for "HIOKI" and download the "GENNECT Cross" app.



\*Android, Google Play and the Google Play logo are trademarks of Google Inc.  
\*IOS is a registered trademark of Cisco Technology, Inc. and/or its affiliates in the United States and certain other countries.  
\*iPhone, iPad, iPad mini, iPad Pro and iPod touch are trademarks of Apple Inc.  
\*Apple and the Apple logo are trademarks of Apple Inc. App Store is a service mark of Apple Inc.  
\*Microsoft, Windows, Windows Vista, and Excel are either registered trademarks or trademarks of Microsoft Corporation in the United States and/or other countries.  
\*Company names and Product names appearing in this catalog are trademarks or registered trademarks of various companies.  
\*The Bluetooth® word mark and logos are registered trademarks owned by Bluetooth SIG, Inc. and any use of such marks by HIOKI E.E. CORPORATION is under license.  
\*For the latest information about countries and regions where wireless operation is currently supported, please visit the HioKI website.

## Our Most Popular Model Offering Reading Stability in Medium-speed Digital Format

### INSULATION TESTER IR4056



IR4056-20



IR4056-21



Comparator function  
Fail alert with Red LED illuminator



Test lead L9788-10  
Bright LED lamp & comparator indicator (green lamp)



CAT III 600 V  
Excluding IR4056-21



#### Basic specifications (Accuracy guaranteed for 1 year)

Rated output voltage	50 V DC	125 V DC	250 V DC	500 V DC	1000 V DC
Effective maximum indicated value	100 MΩ	250 MΩ	500 MΩ	2000 MΩ	4000 MΩ
Accuracy 1st effective measuring range MΩ	±2 % rdg ±2 dgt 0.200 - 10.00	±2 % rdg ±2 dgt 0.200 - 25.0	±2 % rdg ±2 dgt 0.200 - 50.0	±2 % rdg ±2 dgt 0.200 - 500	±2 % rdg ±2 dgt 0.200 - 1000
Lower limit resistance	0.05 MΩ	0.125 MΩ	0.25 MΩ	0.5 MΩ	1 MΩ
Overload protection	600 V AC (10s)				660 V AC (10s)
DC voltage range	4.2 V (0.001 V resolution) to 600 V (1 V resolution), 4 ranges, Accuracy: ±1.3 % rdg ±4 dgt, Input resistance: 100 kΩ or higher				
AC voltage range	420 V (0.1 V resolution) / 600 V (1 V resolution), 2 ranges, 50/60 Hz, Accuracy: ±2.3% rdg ±8 dgt, Input resistance: 100 kΩ or higher, Average rectifier				
Low resistance range	For checking the continuity of ground wiring, 10 Ω (0.01 Ω resolution) to 1000 Ω (1 Ω resolution), 3 ranges, Basic accuracy: ±3 % rdg ±2 dgt, testing current 200 mA or more (at 6 Ω or less)				
Display	Semi-transmissive FSTN LCD with back lighting, bar-graph indicator				
Response time	Approx. 0.8 second for PASS/FAIL decision (based on in-house testing)				
Other functions	Live circuit indicator, Automatic electric discharge, Automatic DC/AC detection, Comparator, Drop proof, Auto power save				
Power supply	LR6 (AA) alkaline batteries ×4, Continuous use: 20 hours (Comparator off, back-light off, 500 V range, no load) Number of measurements: 1000 times (at 5 s ON, 25 s OFF cycle, insulation measurement of lower limit resistance value to maintain nominal output voltage)				
Dimensions and mass	159 mm (6.26 in)W × 177 mm (6.97 in)H × 53 mm (2.09 in)D, 600 g (21.2 oz) (including batteries, excluding test leads)				
Included accessories	[IR4056-20] Test lead L9787 ×1, Neck strap ×1, Instruction manual ×1, LR6 (AA) alkaline batteries ×4 [IR4056-21] Test lead set with remote switch L9788-11 ×1, Neck strap ×1, Instruction manual ×1, LR6 (AA) alkaline batteries ×4				

- 5-range testing voltage of 50 V/100 MΩ to 1000 V/4000 MΩ
- Stable & medium-speed digital readings, 0.8 second response time of PASS/ FAIL decisions
- Drop proof onto concrete from 1m (3.28 feet)
- Bright LED, luminous LCD, test lead with bright LED lamp to illuminate near hand (Also available in the IR4056-21)
- Continuity check via 200 mA testing
- Built in AC/DC voltage meter, useful for testing solar power generation systems and electric vehicles

Model No. (Order Code) **IR4056-20** (Economic model)  
**IR4056-21** (Economic model, Not CE marked)



## Measure PV Insulation Resistance Safely, Accurately and Quickly

### INSULATION TESTER IR4053



option



**TEST LEAD SET WITH REMOTE SWITCH L9788-11**  
Bundled with Remote switch type test lead L9788-10/ Earth lead, alligator clip, 1.2 m (3.94 ft) length



CAT III 600 V



#### ■ Basic specifications (Accuracy guaranteed for 1 year)

##### PVΩ measurement

Rated output voltage	500 V DC	1000 V DC
Effective maximum indicated value	2000 MΩ	4000 MΩ
Measuring range/ Accuracy	0.200 to 500 MΩ / ±4% rdg 501 to 2000 MΩ / ±8% rdg	0.200 to 1000 MΩ / ±4% rdg 1010 to 4000 MΩ / ±8% rdg
Other measuring range / Accuracy	0 to 0.199 MΩ / ±2% rdg ±6 dgt	

##### Insulation resistance measurement

Rated output voltage	50 V DC	125 V DC	250 V DC	500 V DC	1000 V DC
Effective maximum indicated value	100 MΩ	250 MΩ	500 MΩ	2000 MΩ	4000 MΩ
Accuracy 1st effective measuring range MΩ	±4% rdg 0.200 to 10.00	±4% rdg 0.200 to 25.0	±4% rdg 0.200 to 50.0	±4% rdg 0.200 to 500	±4% rdg 0.200 to 1000
Lower limit resistance	0.05 MΩ	0.125 MΩ	0.25 MΩ	0.5 MΩ	1 MΩ
Overload protection	600 V AC (10 s)				1200 V DC (10 s)

- Safely and accurately measure PV insulation resistance even while generating solar power
- Built-in PV dedicated function, display measurements in 4 seconds
- Five ranges (50/125/250/500/1000V) built in for normal insulation resistance measurement
- Built-in 1000 VDC voltage measurement for open voltage tests of PV systems that support 1000 V
- Built-in comparator function
- Drop proof design withstands drop onto concrete from a height of 1 meter

DC voltage range	4.2 V (0.001 V resolution) to 1000 V (1 V resolution), 4 ranges, Accuracy: ±1.3% rdg ±4 dgt, (Ranges in excess of 1000 V are not guaranteed for accuracy)				
AC voltage range	420 V (0.1 V resolution)/600 V (1 V resolution), 2 ranges, 50/60 Hz, Accuracy: ±2.3% rdg ±8 dgt, (Ranges in excess of 600 V are not guaranteed for accuracy)				
Display	Semi-transmissive FSTN LCD with back lighting, Backlight				
Response time	Insulation resistance range: 1 second, PVΩ function: 4 seconds (based on in-house tests)				
Other functions	Live circuit indicator, automatic electric discharge, automatic DC/AC detection, comparator, drop proof, auto power save				
Power supply	AA alkaline batteries (LR6) ×4, Continuous operating time: Approx. 20 hours (based on in-house tests)				
Dimensions and mass	159 mm (6.26 in) W × 177 mm H (6.97 in) H × 53 mm (2.09 in) D, Approx. 600 g (21.2 oz) (including batteries, excluding test lead)				
Included accessories	TEST LEAD L9787 ×1, Neck strap ×1, Instruction manual ×1, AA alkaline batteries (LR6) ×4				

Model No. (Order Code) **IR4053-10** (Bundled with standard Test Lead L9787)

### Shared options for the Insulation Tester IR4058, IR4057, IR4056, and IR4053

<p>Exclusively for the L9787 *The L9787 is bundled (IR4058-20, IR4057-20, IR4056-20, IR4053-10)</p> <p><b>L9787 options</b></p> <div style="display: flex; justify-content: space-around;"> <div style="text-align: center;"> <p><b>TEST LEAD L9787</b> Bundled with Line/ Earth lead, alligator clip, 1.2 m (3.94 ft) length</p> </div> <div style="text-align: center;"> <p><b>BREAKER PIN L9787-91</b> For checking breaker terminal, Detachable for tip of the L9787, 48 mm (1.89 in) length, φ 2.6 mm (0.10 in)</p> </div> </div>	<p>Exclusively for the L9788-10/ L9788-11 *The L9788-11 is bundled (IR4056-21)</p> <p><b>L9788 options</b></p> <div style="display: flex; justify-content: space-around;"> <div style="text-align: center;"> <p><b>TEST LEAD SET WITH REMOTE SWITCH L9788-11</b> Bundled with Test Lead with Remote Switch L9788-10/ Earth lead, alligator clip, 1.2 m (3.94 ft) length</p> </div> <div style="text-align: center;"> <p><b>TEST LEAD WITH REMOTE SWITCH (RED) L9788-10</b> Lighting LED lamp &amp; comparator indicator (Operate only when main unit provides a comparator function), 1.2 m (3.94 ft) length</p> </div> <div style="text-align: center;"> <p><b>TIP PIN L9788-90</b> Spare parts for tip of the L9788/ L9788-10, Tip length 35 mm (1.38 in)</p> </div> <div style="text-align: center;"> <p><b>BREAKER PIN L9788-92</b> For checking breaker terminal, Detachable for tip of the L9788-10, 65 mm (2.56 in) length, φ 2.6 mm (0.10 in)</p> </div> </div>
<p><b>Shared Option</b></p> <div style="display: flex; justify-content: center; align-items: center;"> <div style="margin-left: 10px;"> <p><b>MAGNETIC ADAPTER 9804-02</b> Attaches to the tip of cord, black ×1, φ11 mm (0.43 in)</p> </div> </div>	
<p><b>PC peripherals</b></p> <div style="display: flex; justify-content: center; align-items: center;"> <div style="margin-left: 10px;"> <p><b>GENNECT Cross SF4071, SF4072</b> Mobile app for iOS, Android</p> </div> </div> <p><small>*For the IR4057-90 only (when Z3210 is installed)</small></p>	

## Reliable and Efficient Insulation Testing in the Field

### ANALOG MΩ HiTESTER IR4018



- Single range testing voltage of 1000 V
- Test insulation resistance up to 2000 MΩ
- Built tough to withstand a 1-meter drop onto a concrete floor
- Bright LED luminous scale
- Check for live circuits and battery status
- Integrated hard case for quick and easy storage without disconnecting the leads

Model No. (Order Code) **IR4018-20**

#### Basic specifications (Accuracy guaranteed for 1 year)

Rated output voltage	1000 V DC
Effective maximum indicated value	2000 MΩ
Accuracy 1st effective measuring range	±2 % of scale length, 2 M to 1000 MΩ
Lower limit resistance	1 MΩ (measurement resistance value to maintain testing voltage)
Overload protection	660 V AC (10 sec.)
AC voltage range	0 to 600 V (50/60 Hz), ±5 % of maximum scale value accuracy, 500 kΩ or more input resistance
Other functions	Bright LED luminous scale, Drop proof (on concrete, 1 m/1 time), Battery check, Live circuit check, Auto discharge
Power supply	LR6 (AA) alkaline batteries ×4, Continuous use: 15 hours (no load)
Dimensions and mass	159 mm (6.26 in)W × 177 mm (6.97 in)H × 53 mm (2.09 in)D, 610 g (21.5 oz), (including battery, excluding test lead)
Included accessories	Test lead L9787 ×1, LR6 (AA) alkaline batteries ×4, Instruction manual ×1, Shoulder strap ×1

## Reliable and Efficient Insulation Testing in the Field

### ANALOG MΩ HiTESTER IR4017



- Single range testing voltage of 500 V
- Test insulation resistance up to 1000 MΩ
- Built tough to withstand a 1-meter drop onto a concrete floor
- Bright LED luminous scale
- Check for live circuits and battery status
- Integrated hard case for quick and easy storage without disconnecting the leads

Model No. (Order Code) **IR4017-20**

#### Basic specifications (Accuracy guaranteed for 1 year)

Rated output voltage	500 V DC
Effective maximum indicated value	1000 MΩ
Accuracy 1st effective measuring range	±2 % of scale length, 1 M to 500 MΩ
Lower limit resistance	0.5 MΩ (measurement resistance value to maintain testing voltage)
Overload protection	600 V AC (10 sec.)
AC voltage range	0 to 600 V (50/60 Hz), ±5 % of maximum scale value accuracy, 500 kΩ or more input resistance
Other functions	Bright LED luminous scale, Drop proof (on concrete, 1 m/1 time), Battery check, Live circuit check, Auto discharge
Power supply	LR6 (AA) alkaline batteries ×4, Continuous use: 20 hours (no load)
Dimensions and mass	159 mm (6.26 in)W × 177 mm (6.97 in)H × 53 mm (2.09 in)D, 610 g (21.5 oz), (including battery, excluding test lead)
Included accessories	Test lead L9787 ×1, LR6 (AA) alkaline batteries ×4, Instruction manual ×1, Shoulder strap ×1

## Reliable and Efficient Insulation Testing in the Field

### ANALOG MΩ HiTESTER IR4016



- Single range testing voltage of 500 V
- Test insulation resistance up to 100 MΩ
- Built tough to withstand a 1-meter drop onto a concrete floor
- Bright LED luminous scale
- Check for live circuits and battery status
- Integrated hard case for quick and easy storage without disconnecting the leads

Model No. (Order Code) **IR4016-20**

#### Basic specifications (Accuracy guaranteed for 1 year)

Rated output voltage	500 V DC
Effective maximum indicated value	100 MΩ
Accuracy 1st effective measuring range	±2 % of scale length, 0.1 M to 50 MΩ
Lower limit resistance	0.5 MΩ (measurement resistance value to maintain testing voltage)
Overload protection	600 V AC (10 sec.)
AC voltage range	0 to 600 V (50/60 Hz), ±5 % of maximum scale value accuracy, 500 kΩ or more input resistance
Other functions	Bright LED luminous scale, Drop proof (on concrete, 1 m/1 time), Battery check, Live circuit check, Auto discharge
Power supply	LR6 (AA) alkaline batteries ×4, Continuous use: 20 hours (no load)
Dimensions and mass	159 mm (6.26 in)W × 177 mm (6.97 in)H × 53 mm (2.09 in)D, 610 g (21.5 oz), (including battery, excluding test lead)
Included accessories	Test lead L9787 ×1, LR6 (AA) alkaline batteries ×4, Instruction manual ×1, Shoulder strap ×1

### Shared options for the Analog Megaohm HiTester series IR4018 to IR4016, 3490

Exclusively for the L9787 \*The L9787 is bundled

L9787 options



**TEST LEAD L9787**  
Bundled with Line/Earth lead, alligator clip, 1.2 m (3.94 ft) length

**BREAKER PIN L9787-91**  
For checking breaker terminal, Detachable for tip of the L9787, 48 mm (1.89 in) length, φ 2.6 mm (0.10 in)

Exclusively for the L9788-10/19788-11

L9788 options



**TEST LEAD SET WITH REMOTE SWITCH L9788-11**  
Bundled with Test Lead with Remote Switch L9788-10/Earth lead, alligator clip, 1.2 m (3.94 ft) length

**TEST LEAD WITH REMOTE SWITCH (RED) L9788-10**  
Lighting LED lamp & comparator indicator (Operate only when main unit provides a comparator function), 1.2 m (3.94 ft) length

**TIP PIN L9788-90**  
Spare parts for tip of the L9788/L9788-10, Tip length 35 mm (1.38 in) φ 3.2 mm (0.13 in)

**BREAKER PIN L9788-92**  
For checking breaker terminal, Detachable for tip of the L9788-10, 65 mm (2.56 in) length, φ 2.6 mm (0.10 in)

Attached to the Earth side lead tip

Shared option



**MAGNETIC ADAPTER 9804-02**  
Attaches to the tip of cord, black ×1, φ11 mm (0.43 in)

## Insulation Testing in 3 Easy Steps: Flip the Cover, Select Range & Test

### ANALOG MΩ HiTESTER 3490



- 3-range testing voltage of 250/500 V (insulation resistance testing up to 100 MΩ), and 1000 V (insulation testing up to 4000 MΩ)
- Continuity check at 3 Ω range via 200 mA testing
- Bright LED luminous scale
- Check for live circuits and battery status

Model No. (Order Code) **3490** (Bundled with standard Test Lead L9787)

#### ■ Basic specifications (Accuracy guaranteed for 1 year)

Rated output voltage	250 V DC	500 V DC	1000 V DC
Effective maximum indicated value	100 MΩ	100 MΩ	4000 MΩ
Accuracy 1st effective measuring range	±2 % of scale length 0.05 to 50 MΩ	±2 % of scale length 0.05 to 50 MΩ	±2 % of scale length 2 to 1000 MΩ
Lower limit resistance	0.25 MΩ	0.5 MΩ	1 MΩ
Overload protection	(Measurement resistance value to maintain testing voltage) 660 V AC (10 sec.)		
Low resistance range	3 Ω (at 200 mA testing current), ±0.09 Ω accuracy, 30 Ω (at 20 mA testing current), ±0.9 Ω accuracy, Open-circuit voltage: 4.1 to 6.9 V		
AC voltage range	0 to 600 V (50/60 Hz), ±5 % of maximum scale value accuracy, 100 kΩ or more input resistance		
Other functions	Bright LED luminous scale, Drop proof (on concrete, 1 m/1 time), Battery check, Live circuit check, Auto discharge		
Power supply	LR6 (AA) alkaline batteries ×4, Continuous use: 20 hours (at 500 V range, no load)		
Dimensions and mass	159 mm (6.26 in)W × 177 mm (6.97 in)H × 53 mm (2.09 in)D, 610 g (21.5 oz), (including battery, excluding test lead)		
Included accessories	Test lead L9787 ×1, Instruction manual ×1, Shoulder strap ×1, LR6 (AA) alkaline batteries ×4		

## Maximum 5kV Test Voltage - Up to 10 Teraohm of Insulated Resistance Testing

### HIGH VOLTAGE INSULATION TESTER IR3455



- Measure insulation of high-voltage equipment (such as transformers, cables, and motors)
- Wide testing voltage range, up to 5.00 kV from 250 V DC
- Wide measurement insulation range, up to 10 TΩ
- PI (Polarization Index) and DAR (Dielectric Absorption Ratio) automatically calculated / display
- Data memory function to reduce handwritten notes
- Bright LED luminous scale
- Extended operating temperature range of -10 °C to 50 °C

Model No. (Order Code) **IR3455** (250 V to 5 kV/ 10 TΩ)

#### ■ Basic specifications (Accuracy guaranteed for 1 year)

Test voltage	250 V to 5.00 kV DC, (Possible in 25 V steps between 250 V and 1 kV and in 100 V steps between 1 and 5 kV)
Measurement range	0.00 MΩ to 500 GΩ (250 V) 0.00 MΩ to 1.00 TΩ (500 V) 0.00 MΩ to 2.00 TΩ (1 kV) 0.00 MΩ to 5.00 TΩ (2.5 kV) 0.00 MΩ to 10.0 TΩ (5 kV)
Measurement current	1 mA (Test voltage 250 V to 1.00 kV), 0.5 mA (Test voltage 1.10 kV to 2.50 kV) 0.25 mA (Test voltage 2.60 kV to 5.00 kV), Short-circuit current: 2 mA or less
Resistance range	10 MΩ to 10 TΩ, 7 ranges (auto range)
Accuracy	±5% rdg ±5 dgt Up to [Test voltage (setting value)/Resistance measurable at 100 nA] ±20% rdg ±5 dgt [Test voltage (setting value)/Resistance measurable at 100 nA] to [Test voltage (setting value)/Resistance measurable at 1 nA] or 500 GΩ ±30% rdg ±50 dgt [Test voltage (setting value)/Resistance measurable at 1 nA] or 501 GΩ to 9.99 TΩ
Leakage current measurement	1.00 nA to 1.20 mA, 6 ranges (current measurement that occurs when test voltage is generated) Accuracy ±2.5% rdg ±5 dgt (1 mA range); refer to complete catalog for other ranges
Voltage measurement	±50 V to ±1.00 kV DC, 50 V to 750 V AC (50/60 Hz), Accuracy: ±5 % rdg ±5 dgt , Input resistance: Approx. 10 MΩ
Temperature measurement	-10.0 °C to 70.0 °C, 3 ranges (used with optional sensor) Accuracy ±1.0 °C (0.0 °C to 40.0 °C); refer to complete catalog for other ranges
Other functions	Insulation Diagnosis (Temperature compensation, PI/DAR display, Step voltage test), Data memory, Communication (USB 2.0, PC application software), auto discharge, hot conductor warning indication, etc.
Display	Digital LCD, max. 999 dgt with backlight, Bar graph display
Power supply	LR6 (AA) alkaline batteries ×6, Battery pack 9459, or AC adapter 9753 or 9418-15 (100 - 240 VAC) Continuous use : [LR6] 5 hr, [9459] 9 hr, (Occur 5 kV, +/- open terminal)
Dimensions and mass	260 mm (10.24 in)W × 250.6 mm (9.87 in)H × 119.5 mm (4.70 in)D, 2.8 kg (98.8 oz)
Included accessories	Test lead 9750-01 ×1, Test lead 9750-02 ×1, Test lead 9750-03 ×1, Alligator clip 9751-01 ×1, Alligator clip 9751-02 ×1, Alligator clip 9751-03 ×1, Instruction manual ×1, LR6 (AA) alkaline batteries ×6, USB cable ×1, PC application software (CD-R) ×1

Options



**TEMPERATURE SENSOR 9631-01**  
Molded type, 1 m (3.28 ft) length,  
-40 to 180 °C, 100 sec response time,  
sensor part dimensions φ 6 × 28 mm  
(φ 0.24 in × 1.10 in)



**TEMPERATURE SENSOR 9631-05**  
Molded type, 50 mm (1.97 in) length,  
-40 to 180 °C, 100 sec response time,  
sensor part dimensions φ 6 × 28 mm  
(φ 0.24 in × 1.10 in)



**TEST LEAD 9750-11**  
Red ×1, 10 m (32.81 ft) length  
**TEST LEAD 9750-12**  
Black ×1, 10 m (32.81 ft) length  
**TEST LEAD 9750-13**  
Blue ×1, 10 m (32.81 ft) length



**BATTERY PACK 9459**  
NiMH, Charges while installed in the main unit



**AC ADAPTER 9418-15**  
100 to 240 V AC

Bundled Accessories



**TEST LEAD 9750-01**  
Red ×1, 3 m (9.84 ft) length  
**TEST LEAD 9750-02**  
Black ×1, 3 m (9.84 ft) length  
**TEST LEAD 9750-03**  
Blue ×1, 3 m (9.84 ft) length



**ALLIGATOR CLIP 9751-01**  
Red ×1  
**ALLIGATOR CLIP 9751-02**  
Black ×1  
**ALLIGATOR CLIP 9751-03**  
Blue ×1

# Clamp Meters

## Innovative Current Sensor Design, Easily Get Into Tight Spaces

### AC/DC CLAMP METER CM4375-50



**CE**  
CAT IV 600 V  
CAT III 1000 V  
When using P2000:  
CAT IV 1000 V  
CAT III 2000 V



**True RMS**



When Z3210 is installed



- Easily get into tight spaces between cables thanks to thin sensor structure
- Automatic AC/DC function helps boost work efficiency, Measure up to 1000 A
- Measure DC voltages of up to 2000 V<sup>(\*)</sup> for open voltage inspections of solar panels
- Simultaneously measure inrush current in RMS and crest values
- Easily transfer measurement data to your smartphone or tablet by using our free app GENNECT Cross or to an Excel® file.<sup>(\*\*)</sup>
- Harmonic analysis from 1st to 30th order with GENNECT Cross<sup>(\*\*)</sup>

<sup>\*</sup> When using the optional DC High Voltage Probe P2000. The clamp meter itself is capable of measuring up to 1000 V DC.

<sup>\*\*</sup> Wireless Adapter Z3210 is necessary.

Model No. (Order Code) **CM4375-50** (Wireless Adapter Z3210 not included)  
**CM4375-90** (Bundled with the Wireless Adapter Z3210)  
**CM4375-91** (Bundled with the DC High Voltage Probe P2000)  
**CM4375-92** (Bundled with DC HIGH VOLTAGE PROBE P2000 and Wireless Adapter Z3210)

Shared options for CM4141-50, CM4371-50, CM4373-50 and CM4375-50

#### Basic specifications (Accuracy guaranteed for 1 year)

DC Current range	1000 A, (Max. display 999.9 A), Basic accuracy: $\pm 1.3\%$ rdg. $\pm 0.3$ A (at 30.1 A - 999.9 A)
AC Current range	1000 A (Max. display 999.9 A, 10 Hz to 1 kHz, True RMS), Basic accuracy 45-66 Hz: $\pm 1.8\%$ rdg. $\pm 0.3$ A (at 30.1 A - 900.0 A)
Crest factor	1000 A range: 1.5
DC+AC Current range	1000 A (DC, 10 Hz to 1 kHz, True RMS), Basic accuracy DC, 45-66 Hz: $\pm 1.3\%$ rdg. $\pm 1.3$ A (at 30.1 A - 900.0 A)
DC Power range	0.000 kVA to 1000 kVA (When using P2000: 0 kVA to 2000 kVA) (Automatically switched based on voltage range), Basic accuracy: $\pm 2.0\%$ rdg. $\pm 20$ dgt.
DC Voltage range	600.0 mV to 1000 V (When using P2000: 600.0 V to 2000 V)
AC Voltage range	6.000 V to 1000 V, 4 ranges (15 Hz to 1 kHz, True RMS), Basic accuracy 45 - 66 Hz: $\pm 0.9\%$ rdg. $\pm 0.003$ V (at 6 V)
DC+AC Voltage range	6.000 V to 1000 V, 4 ranges, Basic accuracy DC, 45-66 Hz: $\pm 1.0\%$ rdg. $\pm 0.013$ V (at 6 V)
Resistance range	600.0 $\Omega$ to 6.000 M $\Omega$ , 5 ranges, Basic accuracy: $\pm 0.7\%$ rdg. $\pm 0.5$ $\Omega$ (at 600 $\Omega$ )
Capacitance range	1.000 $\mu$ F to 1000 $\mu$ F, 4 ranges, Basic accuracy: $\pm 1.9\%$ rdg. $\pm 0.005$ $\mu$ F (at 1 $\mu$ F)
Frequency range	9.999 Hz to 999.9 Hz, 3 ranges, Basic accuracy: $\pm 0.1\%$ rdg. $\pm 0.003$ Hz (at 9.999 Hz)
Temperature (K)	-40.0 to 400.0 °C, add temperature probe accuracy to basic accuracy of $\pm 0.5\%$ rdg. $\pm 3.0$ °C
Other functions	Continuity check, Diode check, Automatic AC/DC detection, DC current and DC voltage polarity detection function, MAX/MIN/AVG/ PEAK MAX/PEAK MIN value display, Low-pass filter function, Display value hold, Auto hold, Backlight, Auto power save, Buzzer sound, Zero-adjustment
Dustproof, waterproof	IP54 (While in storage, or when measuring the current an insulated conductor. Do not use when wet.)
Power supply	LR03 Alkaline battery $\times 2$ Continuous use: approx. 40 hr (without Z3210 installed), approx. 20 hr. (with Z3210 installed and using wireless communications) Other conditions: 100 A AC measurement, backlight off, 23°C reference value
Core jaw diameter	$\phi 34$ mm (1.34 in)
Smallest dimension of jaw cross-section	9.5 mm (0.37 in) (Range value of 44 mm (1.73 in) from the tip of the jaw)
Dimensions and mass	65 mm (2.56 in) W $\times$ 242 mm (9.53 in) H $\times$ 35 mm (1.38 in) D mm, 350 g (12.3 oz)
Included accessories	Test Lead L9300, Carrying Case C0203, LR03 Alkaline battery $\times 2$ , Instruction Manual $\times 2$ , Operating Precautions $\times 1$

## True RMS 2000 A AC/DC Clamp Meter for the Toughest Situations With DMM Functions that Deliver Top Safety

### AC/DC CLAMP METER CM4373-50



**CE**  
CAT IV 600 V  
CAT III 1000 V  
When using P2000:  
CAT IV 1000 V  
CAT III 2000 V



**True RMS**



When Z3210 is installed



- Automatic AC/DC function helps boost work efficiency
- Measure DC voltages of up to 2000 V<sup>(\*)</sup> for open voltage inspections of solar panels
- Simultaneously measure inrush current in RMS and crest values
- Easily transfer measurement data to your smartphone or tablet by using our free app GENNECT Cross or to an Excel® file.<sup>(\*\*)</sup>
- Harmonic analysis from 1st to 30th order with GENNECT Cross<sup>(\*\*)</sup>

<sup>\*</sup> When using the optional DC High Voltage Probe P2000. The clamp meter itself is capable of measuring up to 1000 V DC.

<sup>\*\*</sup> Wireless Adapter Z3210 is necessary.

Model No. (Order Code) **CM4373-50** (Wireless Adapter Z3210 not included)  
**CM4373-90** (Bundled with the Wireless Adapter Z3210)  
**CM4373-91** (Bundled with the DC High Voltage Probe P2000)  
**CM4373-92** (Bundled with DC HIGH VOLTAGE PROBE P2000 and Wireless Adapter Z3210)

Shared options for CM4141-50, CM4371-50, CM4373-50 and CM4375-50

#### Basic specifications (Accuracy guaranteed for 1 year)

DC Current range	600.0 A/2000 A, Basic accuracy: $\pm 1.3\%$ rdg. $\pm 0.3$ A (600 A range)
AC Current range	600.0 A/2000 A (10 Hz to 1 kHz, True RMS), Basic accuracy 45 - 66 Hz: $\pm 1.3\%$ rdg. $\pm 0.3$ A (at 600 A)
Crest factor	600.0 A range: 3 or less, 2000 A range: 2.84 or less
DC+AC Current range	600.0 A/2000 A (10 Hz to 1 kHz, True RMS), Basic accuracy DC, 45-66 Hz: $\pm 1.3\%$ rdg. $\pm 1.3$ A (at 600 A)
DC Voltage range	600.0 mV to 1000 V (When using P2000: 600.0 V to 2000 V)
AC Voltage range	6.000 V to 1000 V, 4 ranges (15 Hz to 1 kHz, True RMS), Basic accuracy 45 - 66 Hz: $\pm 0.9\%$ rdg. $\pm 0.003$ V (at 6 V)
DC+AC Voltage range	6.000 V to 1000 V, 4 ranges, Basic accuracy DC, 45 - 66 Hz: $\pm 1.0\%$ rdg. $\pm 0.013$ V (at 6 V)
Resistance range	600.0 $\Omega$ to 6.000 M $\Omega$ , 5 ranges, Basic accuracy: $\pm 0.7\%$ rdg. $\pm 0.5$ $\Omega$ (at 600 $\Omega$ )
Capacitance range	1.000 $\mu$ F to 1000 $\mu$ F, 4 ranges, Basic accuracy: $\pm 1.9\%$ rdg. $\pm 0.005$ $\mu$ F (at 1 $\mu$ F)
Frequency range	9.999 Hz to 999.9 Hz, 3 ranges, Basic accuracy: $\pm 0.1\%$ rdg. $\pm 0.003$ Hz (at 9.999 Hz)
Temperature (K)	-40.0 to 400.0 °C, add temperature probe accuracy to basic accuracy of $\pm 0.5\%$ rdg. $\pm 3.0$ °C
Voltage detection	Hi: 40 V to 600 V AC, Lo: 80 V to 600 V AC, 50/60 Hz
Other functions	DC power, Continuity check, Diode check, Automatic AC/DC detection, Pass/fail judgement function of DC A and DC V, Max/Min/Average/PEAK MAX/PEAK MIN value display, Low-pass filter function, Display value hold, Auto hold, Back light, Auto-power save, Buzzer sounds, Zero-adjustment, etc.
Dustproof, waterproof	IP54 (While in storage, or when measuring the current an insulated conductor. Do not use when wet.)
Power supply	LR03 Alkaline battery $\times 2$ Continuous use: 40 hr (without Z3210 installed), 24 hr. (with Z3210 installed and using wireless communications) Other conditions: 100 A AC measurement, backlight off, 23°C reference value
Core jaw diameter	$\phi 55$ mm (2.17 in), Jaw dimension: 92 mm (3.62 in) W $\times$ 18 mm (0.71 in) D
Dimensions and mass	65 mm (2.56 in) W $\times$ 250 mm (9.84 in) H $\times$ 35 mm (1.38 in) D mm, 530 g (18.7 oz)
Included accessories	Test Lead L9300, Carrying Case C0203, LR03 Alkaline battery $\times 2$ , Instruction Manual $\times 2$ , Operating Precautions $\times 1$

# Clamp Meters

## True RMS 600 A AC/DC Clamp Meter for the Toughest Situations With DMM Functions that Deliver Top Safety

### AC/DC CLAMP METER CM4371-50

**New**



**CE**  
CAT IV 600 V  
CAT III 1000 V  
When using P2000:  
CAT IV 1000 V  
CAT III 2000 V

**3 Year Warranty**

**True RMS**

**Bluetooth**

When Z3210 is installed



Software

GENNECT Cross SF4071, SF4072  
Mobile app for iOS, Android

- Automatic AC/DC function helps boost work efficiency
- Measure DC voltages of up to 2000 V (\*) for open voltage inspections of solar panels
- Simultaneously measure inrush current in RMS and crest values
- Easily transfer measurement data to your smartphone or tablet by using our free app GENNECT Cross or to an Excel® file (\*\*)
- Harmonic analysis from 1st to 30th order with GENNECT Cross (\*\*)

\*1 When using the optional DC High Voltage Probe P2000. The clamp meter itself is capable of measuring up to 1000 V DC.

\*\*2 Wireless Adapter Z3210 is necessary.

Model No. (Order Code) **CM4371-50** (Wireless Adapter Z3210 not included)  
**CM4371-90** (Bundled with the Wireless Adapter Z3210)

#### Basic specifications (Accuracy guaranteed for 1 year)

DC Current range	20.00 A/600.0 A, Basic accuracy: $\pm 1.3\%$ rdg $\pm 0.08$ A (20 A range)
AC Current range	20.00 A/600.0 A (10 Hz to 1 kHz, True RMS), Basic accuracy: $\pm 1.3\%$ rdg $\pm 0.08$ A (at 20 A)
Crest factor	20.00 A range: 7.5, 600.0 A range: 3 or less
DC+AC Current range	20.00 A/600.0 A (10 Hz to 1 kHz, True RMS), Basic accuracy DC, 45-66 Hz: $\pm 1.3\%$ rdg $\pm 0.13$ A (at 20 A)
DC Voltage range	600.0 mV to 1000 V (When using P2000: 600.0 V to 2000 V)
AC Voltage range	6.000 V to 1000 V, 4 ranges (15 Hz to 1 kHz, True RMS), Basic accuracy 45 - 66 Hz: $\pm 0.9\%$ rdg $\pm 0.003$ V (at 6 V)
DC+AC Voltage range	6.000 V to 1000 V, 4 ranges, Basic accuracy DC, 45 - 66 Hz: $\pm 1.0\%$ rdg. $\pm 0.013$ V (at 6 V)
Resistance range	600.0 $\Omega$ to 6.000 M $\Omega$ , 5 ranges, Basic accuracy: $\pm 0.7\%$ rdg. $\pm 0.5$ $\Omega$ (at 600 $\Omega$ )
Capacitance range	1.000 $\mu$ F to 1000 $\mu$ F, 4 ranges, Basic accuracy: $\pm 1.9\%$ rdg. $\pm 0.005$ $\mu$ F (at 1 $\mu$ F)
Frequency range	9.999 Hz to 999.9 Hz, 3 ranges, Basic accuracy: $\pm 0.1\%$ rdg. $\pm 0.003$ Hz (at 9.999 Hz)
Temperature (K)	-40.0 to 400.0 $^{\circ}$ C, add temperature probe accuracy to basic accuracy of $\pm 0.5\%$ rdg $\pm 3.0$ $^{\circ}$ C
Voltage detection	Hi: 40 V to 600 V AC, Lo: 80 V to 600 V AC, 50/60 Hz
Other functions	DC power, Continuity check, Diode check, Automatic AC/DC detection, Pass/fail judgement function of DC A and DC V, Max/Min/Average/PEAK MAX/PEAK MIN value display, Low-pass filter function, Display value hold, Auto hold, Back light, Auto-power save, Buzzer sounds, Zero-adjustment
Dustproof, waterproof	IP54 (While in storage, or when measuring the current an insulated conductor. Do not use when wet.)
Power supply	LR03 Alkaline battery $\times 2$ Continuous use: 40 hr (without Z3210 installed), 20 hr. (with Z3210 installed and using wireless communications) Other conditions: 10 A AC measurement, backlight off, 23 $^{\circ}$ C reference value
Core jaw diameter	$\phi 33$ mm (1.30 in), Jaw dimension: 69 mm (2.72 in) W $\times$ 14 mm (0.55 in) D
Dimensions and mass	65 mm (2.56 in) W $\times$ 215 mm (8.46 in) H $\times$ 35 mm (1.38 in) D mm, 340 g (12.0 oz)
Included accessories	Test Lead L9300, Carrying Case C0203, LR03 Alkaline battery $\times 2$ , Instruction Manual $\times 2$ , Operating Precautions $\times 1$

### Shared options for CM4141-50, CM4371-50, CM4373-50 and CM4375-50

<p>L9207-10 is bundled</p> <p><b>TEST LEAD L9207-10</b> 90 cm (2.95 ft) length</p> <p><b>TEST LEAD L9300</b> 95 cm (37.4 in), Integrated cap and protective finger guard</p>	<p>Attach L9207-10 with the cap removed. Slide the guard of L9300 and attach as measurement category II.</p> <p><b>CONTACT PIN SET L4933</b> Attaches to the tip of the Test Lead L9207-10/ L9300/ DT4911/ L9206, 60V DC/ 30V AC</p> <p><b>SMALL ALLIGATOR CLIP SET L4934</b> Attaches to the tip of the L4932/ L9207-10/ L9300/ DT4911/ L9206, CAT III 300V, CAT II 600V</p>	<p>L4943 is bundled with P2000</p> <p><b>DC HIGH VOLTAGE PROBE P2000</b> CAT III 2000 V</p> <p><b>CONNECTION CABLE SET L4943</b> Bundled with P2000, Cable length: 65 mm (2.56 in)</p>	<p>Temperature measurement</p> <p><b>THERMOCOUPLES(K) DT4910</b> K type, tip exposed, 0.3 mm (0.01 in) diameter, 80 cm (2.62 ft) length, -40 to 260 <math>^{\circ}</math>C (-40 to 500 <math>^{\circ}</math>F)</p>	<p>Bundled accessory</p> <p><b>CARRYING CASE C0203</b></p>
<p>Options for the L4930. Test Pin Set L4932 is required when using the Small Alligator Clip Set L4934</p>				
<p>Options for Test leads</p> <p><b>CONNECTION CABLE SET L4930</b> 1.2 m (3.94 ft) length, CAT IV 600V, CAT III 1000V</p> <p><b>EXTENSION CABLE SET L4931</b> Expands the length of the L4930/L4940, 1.5 m (4.92 ft) length</p>	<p><b>TEST PIN SET L4932</b> Attaches to the tip of the L4930/L4940, CAT IV 600V, CAT III 1000V</p> <p><b>SMALL ALLIGATOR CLIP SET L4934</b> Attaches to the tip of the L4932/ L9207-10/DT4911, L9206, CAT III 300V, CAT II 600V</p>	<p><b>ALLIGATOR CLIP SET L4935</b> Attaches to the tip of the L4930/L4940, CAT IV 600V, CAT III 1000V</p> <p><b>BUS BAR CLIP SET L4936</b> Attaches to the tip of the L4930/L4940, CAT III 600V</p> <p><b>MAGNETIC ADAPTER SET L4937</b> Attaches to the tip of the L4930/L4940, CAT III 1000V</p> <p><b>MAGNETIC ADAPTER 9804</b> Attaches to the tip of voltage cord, <math>\phi 1</math> mm (0.43 in), compatible M6 pan screws</p>	<p><b>TEST PIN SET L4938</b> Attaches to the tip of the L4930/L4940, CAT III 600V</p> <p><b>BREAKER PIN SET L4939</b> Attaches to the tip of the L4930/L4940, CAT III 600V</p> <p><b>GRABBER CLIP L9243</b> Attaches to the tip of the L4930/L4940, CAT II 1000 V, 185 mm (7.28 in) length</p>	

## Compact & Easy, One-Touch Maintenance on All Types of AC/DC Equipment

### CLAMP ON AC/DC HITESTER 3288



3288



3288-20

**CE**  
CAT III 600 V (Current)  
CAT III 300 V (Voltage)  
CAT II 600 V (Voltage)

**3 Year Warranty**

**True RMS**

- Model 3288-20: True RMS
- Use the 3288 for high current measurements such as UPS emergency batteries and train motors
- Voltage, resistance, and continuity check functions

Model No. (Order Code) **3288** (Average rectified)  
**3288-20** (True RMS)

#### Basic specifications (Accuracy guaranteed for 1 year)

	<b>3288</b>	<b>3288-20</b>
DC Current range	100.0/ 1000 A, Basic accuracy: $\pm 1.5\%$ rdg $\pm 5$ dgt	100.0/ 1000 A, Basic accuracy: $\pm 1.5\%$ rdg $\pm 5$ dgt
AC Current range	100.0/ 1000 A, (10 Hz to 500 Hz, Average rectified), Basic accuracy: $\pm 1.5\%$ rdg $\pm 5$ dgt	100.0/ 1000 A, (10 Hz to 500 Hz, True RMS), Basic accuracy: $\pm 1.5\%$ rdg $\pm 5$ dgt
DC Voltage range	419.9 mV to 600 V, 5 ranges, Basic accuracy: $\pm 1.3\%$ rdg $\pm 4$ dgt	
AC Voltage range	4.199 V to 600 V, 4 ranges, Basic accuracy: $\pm 2.3\%$ rdg $\pm 8$ dgt (30 to 500 Hz, Average rectified)	4.199 V to 600 V, 4 ranges, Basic accuracy: $\pm 2.3\%$ rdg $\pm 8$ dgt (30 to 500 Hz, True RMS)
Resistance range	419.9 $\Omega$ to 41.99 M $\Omega$ , 6 ranges, Basic accuracy: $\pm 2\%$ rdg $\pm 4$ dgt	
Crest factor	N/A	3 or less (2 at 1000 A range, 1.5 at Voltage)
Other functions	Continuity: (50 $\Omega$ $\pm 40$ $\Omega$ ) or less buzzer sounds, Data hold, Auto power save, Auto zero (DC A)	
Display	LCD, max. 4199 dgt, Display refresh rate: 2.5 times/s	
Power supply	Coin type lithium battery (CR2032) $\times 1$ , Continuous use 60 hours	Coin type lithium battery (CR2032) $\times 1$ , Continuous use 35 hours
Core jaw dia.	$\phi 35$ mm (1.38 in)	
Dimensions and mass	57 mm (2.24 in)W $\times$ 180 mm (7.09 in)H $\times$ 16 mm (0.63 in)D, 150 g (5.3 oz)	
Included accessories	Coin type lithium battery (CR2032) $\times 1$ , Carrying case 9398 $\times 1$ , Test lead L9208 $\times 1$ , Instruction manual $\times 1$	

Bundled Accessories

**CARRYING CASE 9398**

**TEST LEAD L9208**  
70 cm (2.30 ft) length

**TEST LEADS HOLDER 9209**  
Secures one end of each test lead to the rear of the meter

Field Measuring Instruments

## Compact & Easy, One-Touch Maintenance on All Types of AC/DC Equipment

### CLAMP ON AC/DC HI-TESTER 3287



- Accurately measure even small currents with 10 A range
- Voltage, resistance, and continuity check functions

Model No. (Order Code) **3287** (True RMS)

#### Basic specifications (Accuracy guaranteed for 1 year)

DC Current range	10.00/ 100.0 A, Basic accuracy: $\pm 1.5\%$ rdg $\pm 5$ dgt
AC Current range	10.00/ 100.0 A (10 Hz to 1 kHz, True RMS) Basic accuracy: $\pm 1.5\%$ rdg $\pm 5$ dgt
DC Voltage range	419.9 mV to 600 V, 5 ranges, Basic accuracy: $\pm 1.3\%$ rdg $\pm 4$ dgt
AC Voltage range	4.199 V to 600 V, 4 ranges (30 to 500 Hz, True RMS) Basic accuracy: $\pm 2.3\%$ rdg $\pm 8$ dgt
Resistance range	419.9 $\Omega$ to 41.99 M $\Omega$ , 6 ranges, Basic accuracy: $\pm 2\%$ rdg $\pm 4$ dgt
Crest factor	2.5 or less (150 A, 1000 V max.)
Other functions	Continuity: (50 $\Omega$ $\pm$ 40 $\Omega$ ) or less buzzer sounds, Data hold, Auto power save, Auto zero (DC A)
Display	LCD, max. 4199 dgt, Display refresh rate: 2.5 times/s
Power supply	Coin type lithium battery (CR2032) $\times$ 1, Continuous use 25 hours
Core jaw dia.	$\phi$ 35 mm (1.38 in)
Dimensions and mass	57 mm (2.24 in)W $\times$ 180 mm (7.09 in)H $\times$ 16 mm (0.63 in)D, 170 g (6.0 oz)
Included accessories	Coin type lithium battery (CR2032) $\times$ 1, Carrying case 9398 $\times$ 1, Test lead L9208 $\times$ 1, Instruction manual $\times$ 1



# Clamp Meters

## True RMS 2000 A AC Clamp Meter Innovative Current Sensor Design - Easily Get Into Tight Spaces

### AC CLAMP METER CM4141-50

**New**



**CE**  
CAT IV 600 V  
CAT III 1000 V  
When using P2000:  
CAT IV 1000 V  
CAT III 2000 V

**3 Year Warranty**

**True RMS**

**Bluetooth**  
When Z3210 is installed

- Easily get into tight spaces between cables thanks to thin sensor with a mini-mum cross-section span of 11 mm
- Measure up to 2000 A AC
- Measure DC voltages of up to 2000 V<sup>(1)</sup> for open voltage inspections of solar panels
- AC A, AC and DC V, DC+AC V, resistance, frequency, temperature, and more
- Easily transfer measurement data to your smartphone or tablet by using our free app GENNECT Cross or to an Excel® file<sup>(2)</sup>
- Harmonic analysis from 1st to 30th order with GENNECT Cross<sup>(2)</sup>

<sup>1</sup> When using the optional DC High Voltage Probe P2000. The clamp meter itself is capable of measuring up to 1000 V DC.

<sup>2</sup> Wireless Adapter Z3210 is necessary.

Model No. (Order Code) **CM4141-50** (Wireless Adapter Z3210 not included)  
**CM4141-90** (Bundled with the Wireless Adapter Z3210)

Shared options for CM4141-50, CM4371-50, CM4373-50 and CM4375-50

#### Basic specifications (Accuracy guaranteed for 1 year)

AC Current range	60.00 A to 2000 A, 3 ranges (45 Hz to 1 kHz, True RMS), Basic accuracy 45-66 Hz: $\pm 1.5\%$ rdg. $\pm 0.08$ A (60 A range)
Crest factor	For the 60.00 A range: 2.5 (greater than 50.00 A and less than or equal to 60.00 A) to 2000 A range: 1.5 (2000 A or less)
DC Voltage range	600.0 mV to 1000 V (When using P2000: 600.0 V to 2000 V)
AC Voltage range	6.000 V to 1000 V, 4 ranges (15 Hz to 1 kHz, True RMS), Basic accuracy 45-66 Hz: $\pm 0.9\%$ rdg. 0.003 V (at 6 V)
DC+AC Voltage range	6.000 V to 1000 V, 4 ranges, Basic accuracy DC, 45-66 Hz: $\pm 1.0\%$ rdg. $\pm 0.013$ V (at 6 V)
Resistance range	600.0 $\Omega$ to 6.000 M $\Omega$ , 5 ranges, Basic accuracy: $\pm 0.7\%$ rdg. $\pm 0.5$ $\Omega$ (at 600 $\Omega$ )
Capacitance range	1.000 $\mu$ F to 1000 $\mu$ F, 4 ranges, Basic accuracy: $\pm 1.9\%$ rdg. $\pm 0.005$ $\mu$ F (at 1 $\mu$ F)
Frequency range	Voltage: 9.999 Hz to 999.9 Hz 3 ranges, Current: 99.99 Hz to 999.9 Hz 2 ranges, Basic accuracy: $\pm 0.1\%$ rdg. $\pm 0.01$ Hz (at 99.99 Hz)
Temperature (K)	-40.0 to 400.0 °C, Basic accuracy: $\pm 0.5\%$ rdg $\pm 3.0$ °C + temperature probe accuracy
Other functions	Continuity check, Diode check, Automatic AC/DC detection (Voltage check only), Max/Min/AVG/Peak waveform MAX/Peak waveform MIN value display, Low-pass filter function, Display value hold, Backlight, Auto power save, Buzzer sound, Zero-adjustment, and other function
Dustproof, water-proof	IP20 (current measurement of voltage or hazardous live conductors under completely dry condition. Do not use when wet.) IP50 (when measuring resistance, or current of an insulated conductor (completely dry), and in storage)
Power supply	LR03 Alkaline battery $\times 2$ Continuous use: approx. 48 hr (without Z3210 installed), approx. 24 hr. (with Z3210 installed and using wireless communications) Other conditions: 100 A AC measurement, backlight off, 23°C reference value
Core jaw diameter	$\phi 55$ mm (2.17 in), Jaw dimension: 82 mm (3.23 in) W $\times$ 11 mm (0.43 in) D (D dimension is a range value of 44 mm (1.73 in) from the tip of the jaw)
Smallest dimension of jaw cross-section	11 mm (0.43 in) (Range value of 44 mm (1.73 in) from the tip of the jaw)
Dimensions and mass	65 mm (2.56 in) W $\times$ 247 mm (9.72 in) H $\times$ 35 mm (1.38 in) D, 300 g (10.6 oz)
Included accessories	Test Lead L9300 $\times 1$ , Carrying Case C0203 $\times 1$ , LR03 Alkaline battery $\times 2$ , Instruction Manual $\times 2$ , Operating Precautions $\times 1$

## Rugged & Compact, Quickly clamp wires in even more confined spaces!

### AC CLAMP METER 3280-10F, CM3289



3280-10F



CM3289

**CE**  
CAT IV 300 V (Current)  
CAT III 600 V (Current)  
CAT III 300 V (Voltage)  
CAT II 600 V (Voltage)

**Drop-proof**

**3 Year Warranty**

**True RMS**

- The CM3289 is the successor to the popular 3280-20F with a redesigned thinner sensor to help you get into the tightest spaces.
- New redesigned sensor for even easier clamping (CM3289)
- Expanded -25 °C to 65 °C operating temperature range
- Model CM3289: Measure even harmonic waveform components using the True RMS method
- Model 3280-10F: Measure the fundamental waveform component using the average rectified method
- Connect the CT6280 flexible sensor to measure up to 4199 A in thick or paired wires

Model No. (Order Code) **3280-10F** (Average rectified)  
**3280-70F** (3280-10F, CT6280 bundled model)  
**CM3289** (True RMS)

Note: The 3280-70F includes both the meter and an AC Flexible Current Sensor.

1: AC CLAMP METER 3280-10F  $\times 1$

2: AC FLEXIBLE CURRENT SENSOR CT6280  $\times 1$  3: CARRYING CASE C0205  $\times 1$

#### Basic specifications (Accuracy guaranteed for 1 year)

	3280-10F	CM3289
AC Current range	42.00 to 1000 A, 3 ranges (50 to 60 Hz, Average rectified), Basic accuracy: $\pm 1.5\%$ rdg $\pm 5$ dgt	42.00 to 1000 A, 3 ranges (40 Hz to 1 kHz, True RMS), Basic accuracy: $\pm 1.5\%$ rdg $\pm 5$ dgt
DC Voltage range	420.0 mV to 600 V, 5 ranges, Basic accuracy: $\pm 1.0\%$ rdg $\pm 3$ dgt	
AC Voltage range	4.200 V to 600 V, 4 ranges (45 to 500 Hz, Average rectified), Basic accuracy: $\pm 1.8\%$ rdg $\pm 7$ dgt	4.200 V to 600 V, 4 ranges (45 to 500 Hz, True RMS), Basic accuracy: $\pm 1.8\%$ rdg $\pm 7$ dgt
Crest factor	N/A	2.5 or less at 2500 counts (Linearly decreases to 1.5 or less at 4200 count)
Resistance range	420.0 $\Omega$ to 42.00 M $\Omega$ , 6 ranges, Basic accuracy: $\pm 2\%$ rdg $\pm 4$ dgt	
Other functions	Continuity: Buzzer sounds at 50 $\Omega$ $\pm 40$ $\Omega$ or less, Data hold, Auto power save, Drop-proof from height of 1 meter	
Display	LCD, max. 4199 dgt, Display refresh rate: 400 ms	
Power supply	Coin type lithium battery (CR2032) $\times 1$ , Continuous use 120 hours	Coin type lithium battery (CR2032) $\times 1$ , Continuous use 70 hours
Core jaw dia.	$\phi 33$ mm (1.30 in)	
Dimensions and mass	57 mm (2.24 in) W $\times$ 175 mm (6.89 in) H $\times$ 16 mm (0.63 in) D, 100 g (3.5 oz)	57 mm (2.24 in) W $\times$ 181 mm (7.13 in) H $\times$ 16 mm (0.63 in) D, 100 g (3.5 oz)
Included accessories	CARRYING CASE 9398 $\times 1$ , TEST LEAD L9208 $\times 1$ , Coin type lithium battery (CR2032) $\times 1$ , Instruction manual $\times 1$	

#### CT6280 Basic specifications (Accuracy guaranteed for 1 year)

Core jaw dia.	$\phi 130$ mm (5.12 in) Cable cross-section diameter: 5 mm (0.20 in), tip cap diameter: 7 mm (0.28 in)
AC Current	419.9 A/ 4199 A, 2 ranges ( $\pm 3.0\%$ rdg $\pm 5$ dgt)
Cable length	800 mm (31.5 in)

Bundled Accessories



TEST LEAD L9208  
70 cm (2.30 ft) length



CARRYING CASE  
9398

Options



AC FLEXIBLE CURRENT  
SENSOR CT6280  
Includes C0205 and attachment



CARRYING CASE  
C0205  
The CT6280, L9208, and  
tester can be stored



TEST LEADS HOLDER  
9209  
Secures one end of each test lead  
to the rear of the meter

Attach L9208 with the cap removed.



CONTACT PIN SET  
L4933  
Attaches to the tip of the Test  
Lead L9208, 60V DC/ 30V AC



SMALL ALLIGATOR CLIP  
SET L4934  
Attaches to the tip of the L9208,  
CAT III 300V, CAT II 600V

Field Measuring  
Instruments

# Clamp Meters

## Large Jaw Lets You Clamp with Ease, Measure Thick Cables Right at the Terminal

### AC CLAMP METER CM3281, CM3291



CE  
CAT IV 300 V  
CAT III 600 V

Drop-proof

3 Year Warranty

True RMS  
CM3291

- AC only, measure up to 2000 AAC
- -25 °C to 65 °C operating temperature range
- Also measure resistance, continuity, AC and DC voltage

Model No. (Order Code) **CM3281** (Average rectified)  
**CM3291** (True RMS)

#### Basic specifications (Accuracy guaranteed for 1 year)

	CM3281	CM3291
AC Current range	42.00 to 2000 A, 3 ranges (50 Hz to 60 Hz, Average rectified), Basic accuracy 50-60 Hz: $\pm 1.5\%$ rdg $\pm 5$ dgt	42.00 to 2000 A, 3 ranges (40 Hz to 1 kHz, True RMS), Basic accuracy 45-66 Hz: $\pm 1.5\%$ rdg $\pm 5$ dgt
DC Voltage range	420.0 mV to 600 V, 5 ranges, Basic accuracy: $\pm 1.0\%$ rdg $\pm 3$ dgt (at 4.2 V range)	
AC Voltage range	4200 V to 600 V, 4 ranges (45 to 500 Hz, Average rectified), Basic accuracy 45-66 Hz: $\pm 1.8\%$ rdg $\pm 7$ dgt (at 4.2 V range)	4200 V to 600 V, 4 ranges (45 to 500 Hz, True RMS), Basic accuracy 45-66 Hz: $\pm 1.8\%$ rdg $\pm 7$ dgt (at 4.2 V range)
Crest factor	N/A	For 2500 counts or less, 2.5 Reduces linearly to 1.5 or less at 4200 counts But, 1.5 or less for 2000 A ACA range
Resistance range	420.0 $\Omega$ to 42.00 M $\Omega$ , 6 ranges, Basic accuracy: $\pm 2.0\%$ rdg $\pm 4$ dgt (at 420 $\Omega$ range)	
Other functions	Continuity check: Buzzer sounds at 50 $\Omega$ $\pm 40\%$ or less, Data hold, Auto power save, Drop-proof from height of 1 meter	
Power supply	Coin type lithium battery (CR2032) $\times 1$ , Continuous use 120 hours	Coin type lithium battery (CR2032) $\times 1$ , Continuous use 70 hours
Core jaw diameter	$\phi$ 46 mm (1.81 in), Jaw dimension: 65 mm (2.56 in) W $\times$ 13 mm (0.51 in) D	
Dimensions and mass	57 mm (2.24 in) W $\times$ 198 mm (7.80 in) H $\times$ 16 mm (0.63 in) D, 103 g (3.6 oz)	
Included accessories	Carrying case $\times 1$ , TEST LEAD L9208 $\times 1$ , Coin type lithium battery CR2032 (for trial purposes only) $\times 1$ , Instruction manual $\times 1$ , Download guide $\times 1$ , Operating precautions $\times 1$	

#### CT6280 Basic specifications (Accuracy guaranteed for 1 year)

Core jaw dia.	$\phi$ 130 mm (5.12 in) (Cable cross-section diameter: 5 mm (0.20 in); tip cap diameter: 7 mm (0.28 in))
AC Current	419.9 A / 4199 A, 2 ranges ( $\pm 3.0\%$ rdg $\pm 5$ dgt)
Cable length	800 mm (31.5 in)

#### Shared options for the CM3281, CM3291

Bundled Accessories			Options			
	TEST LEAD L9208 70 cm (2.30 ft) length	Carrying case C0205 Hard type, 222 mm (8.74 in) W $\times$ 115 mm (4.53 in) H $\times$ 46 mm (1.81 in) D		AC FLEXIBLE CURRENT SENSOR CT6280 Includes carrying case C0205	CONTACT PIN SET L4933 Attaches to the tip of the Test Lead L9208, 60V DC / 30V AC	SMALL ALLIGATOR CLIP SET L4934 Attaches to the tip of the L9208, CAT III 300V, CAT II 600V

## For large diameter and large current measurement in combination with AC clamp meter

### AC FLEXIBLE CURRENT SENSOR CT6280



CE  
CAT IV 300 V  
CAT III 600 V

3 Year Warranty

CT6280 + 3280-10F

- Large-diameter loop is ideal for measuring large wires and pairs of wires.
- In small spaces
- Freely bendable

Model No. (Order Code) **CT6280** (For the CM3291/89, 3280-10F and similar products)

#### CT6280 Basic specifications (Accuracy guaranteed for 1 year)

Maximum input current	4200 A AC, continuous (50 Hz to 60 Hz)
Core jaw dia.	$\phi$ 130 mm (5.12 in) (Cross-section diameter of sensor cable: $\phi$ 5 mm (0.20 in); Sensor-tip cap diameter: $\phi$ 7 mm (0.28 in))
Dimensions and mass	42 mm (1.65 in) W $\times$ 65 mm (2.56 in) H $\times$ 18 mm (0.71 in) D (excluding the flexible loop and output cable), 71 g (2.5 oz)
Cable length	800 mm (31.5 in)
Included accessory	Carrying case C0205 $\times 1$

Note: CT6280 is a flexible current sensor for measuring large currents. It is not suitable for measuring minute current such as leakage current.



CARRYING CASE C0205  
Soft case

#### Essential equipment for professional electricians (AC FLEXIBLE CURRENT SENSOR CT6280/option)

**Thin and strong clamp meter**

AC FLEXIBLE CURRENT SENSOR

$\phi$ 130 mm (5.12")  
4200 A AC

Use with an AC Clamp Meter to measure large wires and currents.

Large diameter loop is ideal for measuring large wires and pairs of wires.

In small spaces

Tip is fixed in an L-shape for easy manipulation in confined spaces

Note: CT6280 is a flexible current sensor for measuring large currents. It is not suitable for measuring minute current such as leakage current.

Freely bendable

CARRYING CASE C0205



## Leakage Current Meter with Remarkable Ease of Use. Double Your Work Speed with Innovative Jaw Design.

### AC LEAKAGE CLAMP METER CM4001



Slim jaws,  
Core jaw diameter: φ24 mm



When Z3210 is installed



Germany iF Design Award

- Slim jaws let you work with ease
- Measure everything from leakage to load
- Identify intermittent GFCI and RCD trips to prevent unplanned equipment downtime by testing for earth leakage current
- Find issues faster with comparator function
- Wireless support. Transfers measurements to your smartphone or tablet and allows you to quickly create reports with field photos and drawings. (Optional Wireless Adapter Z3210 is necessary)

Model No. (Order Code) **CM4001** (Wireless Adapter Z3210 not included)  
**CM4001-90** (Bundled with the Wireless Adapter Z3210)

#### Basic specifications (Accuracy guaranteed for 1 year)

AC Current range	60.00 mA/ 600.0 mA/ 6.000 A/ 60.00 A/ 600.0 A, 5 ranges (40 Hz to 1 kHz, True RMS) Basic accuracy (45-66 Hz): ±1.5% rdg ±5 dgt (60.00 mA to 6.000 A), ±2.5% rdg ±5 dgt (60.00 A to 600.0 A) Guaranteed accuracy: from 0.60 mA to 600.0A
AC Voltage range	N/A
Frequency range	40.0 Hz to 999.9 Hz
Crest factor	4.5 (4000 counts or less) 3 (more than 4000 counts, 6000 counts or less)
Filter function	Cut off frequency: 180 Hz ±30 Hz at filter ON (-3 dB)
Output function	N/A
Other functions	Comparator function, record Max/Min/Avg value, backlight, data hold, auto power off, AC inrush function
Display	Display refresh rate: 5 times/s
Power supply	LR03 alkaline battery × 1; 32 hours of continuous use
Core jaw diameter	φ 24 mm (0.94 in)
Dimensions and mass	37 mm (1.46 in) W × 160 mm (6.30 in) H × 27 mm (1.06 in) D, 115 g (4.1 oz.)
Included accessories	Carrying case × 1, Strap × 1, Instruction manual × 1, Operating Precautions × 1, LR03 alkaline battery × 1



## Prevent unexpected downtime! Identify potential problems and avoid large problems

### AC LEAKAGE CLAMP METER CM4002, CM4003



CM4002

CM4003



CAT IV 300 V  
CAT III 600 V (CM4002)  
CAT III 300 V (CM4003)



When Z3210 is installed



Germany iF Design Award

- Easily transfer measurement data to your smartphone or tablet by using our free app GENNECT Cross or to an Excel® file. (Wireless Adapter Z3210 is necessary)
- Detect minuscule leakage currents with a newly designed sensor. (Core jaw diameter up to φ 40 mm)
- Broad measurement range extending from leakage currents to load currents
- Complies with the performance standard set forth in IEC/EN 61557-13, an international standard on leak clamp meters
- Solve GFCI and RCD problems quickly
- Speed up pass/fail judgments with the built-in comparator function
- Output function (waveform/RMS): use with a recorder to record waveforms and fluctuations (CM4003 only)
- External power supply: use an optional AC adapter for continuous, long-term measurement (CM4003 only)

Model No. (Order Code) **CM4002** (Wireless Adapter Z3210 not included)  
**CM4002-90** (Bundled with the Wireless Adapter Z3210)  
**CM4003** (Wireless Adapter Z3210 not included)  
**CM4003-90** (Bundled with the Wireless Adapter Z3210)

#### Basic specifications (Accuracy guaranteed for 1 year)

	CM4002	CM4003
AC Current range	6.000 mA, 60.00 mA, 600.0 mA, 6.000 A, 60.00 A, 200.0 A, 6 ranges, True RMS Basic accuracy 45 Hz - 400 Hz: ±1.0% rdg ±5 dgt (6.000 mA to 6.000 A), ±1.5% rdg ±5 dgt (60.00 A, 200.0 A) Basic accuracy 15 Hz - 45 Hz, 400 Hz - 2 kHz: ±2.0% rdg ±5 dgt Defined accuracy range: 0.060 mA to 200.0 A	
AC Voltage range	N/A	
Frequency range	15.0 Hz to 2000 Hz	
Crest factor	3 (other than 200.0 A range), 1.5 (200.0 A range)	
Filter function	Cut off frequency: 180 Hz ±30 Hz at filter ON (-3 dB)	
Output function	N/A	RMS (RMS value output), WAVE (waveform output)
Other functions	Max/ Min/ AVG/ PEAK MAX/ PEAK MIN value display, Display value hold and auto hold; Backlight, Auto power save, Buzzer sound, Event count display, Comparator, Simple event recording, Rush current measurement	
Display	Display refresh rate: 5 times/s	
Power supply	AA-size alkaline battery (LR6) × 2; Continuous operating time: 48 hr. (without Z3210 installed), 30 hr. (with Z3210 installed and using wireless communications)	
Core jaw diameter	φ 40 mm (1.57 in.)	
Dimensions and mass	64 mm (2.52 in) W × 233 mm (9.17 in) H × 37 mm (1.46 in) D, 400 g (14.1 oz.)	
Included accessories	Carrying case C0203 × 1, Instruction manual × 1, Operating Precautions × 1, AA-size alkaline battery (LR6) × 2	

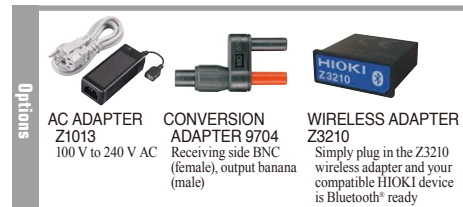
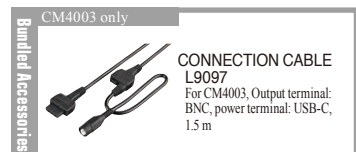

## Easy Pole Clamp-On Ground Resistance Tester with Super Slim Jaw

### CLAMP ON EARTH TESTER FT6380-50



Bluetooth®  
When Z3210 is installed

- Easily transfer measurement data to your smartphone or tablet by using our free app GENNECT Cross or to an Excel® file. (Wireless Adapter Z3210 is necessary)
- Earth resistance measurement for multi-grounded systems
- Measure leak current with absolute certainty with highly sensitive 0.01 mA resolution (at 20.00 mA range)
- Measure load current up to 60.0 A range
- Clamp at the narrowest point

Model No. (Order Code) **FT6380-50** (Wireless Adapter Z3210 not included)  
**FT6380-90** (Bundled with the Wireless Adapter Z3210)

#### Basic specifications (Accuracy guaranteed for 1 year)

Measurement principle	Instrument has two cores for voltage injection and current measurement. From the defined voltage and measured current, the total circuit loop resistance is calculated Note: For multi grounded systems only. In a multi-grounded system, the larger the number of grounding poles, the more accurate the measured value.
Earthing resistance range	0.20 Ω (0.01 Ω resolution) to 1600 Ω (20 Ω resolution), 10 ranges, Zero suppression: Less than 0.02 Ω, Accuracy: ±1.5 % rdg. ±0.02 Ω
AC Current range	20.00 mA (0.01 mA resolution) to 60.0 A (0.1 A resolution), 5 ranges, Zero suppression: Less than 0.05 mA, Accuracy: ±2.0 % rdg. ±0.05 mA (30 Hz to 400 Hz, True RMS), Crest factor 5.0 or less (for the 60 A range, 1.7 or less)
Maximum input current (Current measurement)	100 A AC continuous, AC 200 A for 2 minutes or shorter (at 50 Hz/60 Hz, requires derating at frequency)
Maximum rated terminal-to-ground voltage	600 VAC measurement category IV (anticipated transient overvoltage 8000 V)
Memory function	2000 data
Alarm function	For resistance measurement and current measurement, Beeps when measured value is less than or greater than threshold.
Other functions	Data hold, Backlight, Filter, Auto power save, Wireless communication (without Z3210 installed)
Display	LCD, Max. 2,000 count Display refresh rate: Approx. 2 times/sec.
Dust-proof and waterproof	IP40 (EN60529) With Jaws Closed
Power supply	LR6 alkaline battery × 2
Continuous operating time	Approx. 40 hours (25 Ω measurement, backlight off, without Z3210 installed) Approx. 35 hours (25 Ω measurement, backlight off, with Z3210 installed and using wireless communications)
Maximum measurable conductor diameter	φ 32 mm (1.26 in)
Dimensions and mass	73 mm (2.87 in) W × 218 mm (8.58 in) H × 43 mm (1.69 in) D, 620 g (21.9 oz)
Included accessories	Carrying case, Resistance check loop (1 Ω±2%, 25Ω±1%), Strap, LR6 alkaline battery × 2, Instruction manual



## Tough and Ready for the Field, IP67 Dustproof and Waterproof

### EARTH TESTER FT6031-50



**Bluetooth**

When Z3210 is installed

**CE**

CAT IV 100 V  
CAT III 150 V  
CAT II 300 V

**Drop-proof**

**3 Year Warranty**

- Wireless support. Transfers measurements to your smartphone or tablet and allows you to quickly create reports with field photos and drawings. (Optional Wireless Adapter Z3210 is necessary)
- Excellent noise resistance
- IP67 protected – top of the industry
- Test all ground types from Class A to Class D with a single meter
- Wide 0Ω to 2000Ω measurement range
- Minimize cabling time with innovative earthing rods and cable winder

Model No. (Order Code) **FT6031-50** (Wireless Adapter Z3210 not included)  
**FT6031-90** (Bundled with the Wireless Adapter Z3210)

#### Basic specifications (Accuracy guaranteed for 1 year)

Measurement system	Two-electrode method/three-electrode method (switchable)		
Measurement range	20 Ω (0 to 20.00 Ω)	200 Ω (0 to 200.0 Ω)	2000 Ω (0 to 2000 Ω)
Accuracy	±1.5 %rdg ±8 dgt	±1.5 %rdg ±4 dgt	±1.5 %rdg ±4 dgt
Earth voltage	0 to 30.0 V rms Accuracy: ±2.3% rdg ±8 dgt (50 Hz/60 Hz), ±1.3% rdg ±4 dgt (DC)		
Allowable earth potential	25.0 V rms (DC or sine wave)		
Dustproof and waterproof	IP65/IP67 (EN60529)		
Power supply	LR6 Alkaline battery ×4, Possible number of measurements: 500 times (measurement conditions: three-electrode method, measuring 10 Ω at 10-second intervals without Z3210 installed)		
Functions	Live wire warning, zero-adjustment, continuous measurement mode, wireless communication (only when Z3210 is connected), and comparator		
Dimensions and mass	185 mm (7.28 in)W × 111 mm (4.37 in)H × 44 mm (1.73 in)D, 570 g (20.1 oz.) (including batteries and protector, excluding terminal covers and other accessories)		
Included accessories	Auxiliary Earthing Rod L9840 (2 piece set) ×1, Measurement Cable L9841 (black 4 m) ×1, Measurement Cable L9842-11 (yellow 10 m, equipped with winder) ×1, Measurement Cable L9842-22 (red 20 m, equipped with winder) ×1, Carrying Case C0106 ×1, Protector ×1, LR6 Alkaline battery ×4, Instruction manual ×1		

To ensure safety, use the optional Test Lead L9787 when making measurements using the two-electrode method.

Software	When Z3210 is installed	Bundled Accessories				
	GENNECT Cross SF4071, SF4072 Mobile app for iOS, Android	MEASUREMENT CABLE L9842-11 Yellow, 10 m (32.81 ft), equipped with winder	MEASUREMENT CABLE L9842-22 Red, 20 m (65.62 ft), equipped with winder	MEASUREMENT CABLE L9841 Black alligator clip, 4 m (13.12 ft) length	AUXILIARY EARTHING ROD L9840 2 piece set, stainless steel	CARRYING CASE C0106 Soft type, includes compartment for options
Options	L9844: for earthing terminal board, L9787: for two-electrode method, indoor use only					
	WIRELESS ADAPTER Z3210 Simply plug in the Z3210 wireless adapter and your compatible HIOKI device is Bluetooth® ready	EARTH NETS 9050 Set of two, 30 cm (11.81 in) × 30 cm (11.81 in)	MEASUREMENT CABLE L9844 Red/yellow/black 1.2 m (3.94 ft) length	TEST LEAD L9787 Bundled with alligator clip, 1.2 m (3.94 ft) length	MEASUREMENT CABLE L9843-51 Yellow, 50 m (164.06 ft) length, equipped with flat cable winder	MEASUREMENT CABLE L9843-52 Red, 50 m (164.06 ft) length, equipped with flat cable winder

## Classic Ground Resistance Tester via 3-Pole Method with Easy Cord Winding System

### ANALOG EARTH TESTER FT3151



**CE**

CAT II 300 V

**3 Year Warranty**

- Three-electrode method, Two-electrode method (Simple Measurement)
- Wide measurement range for 0 to 1150 Ω, based on EN standard
- Switchable measurement frequency to reduce the effects of power supply harmonics
- Dramatically faster setup: Comes with improved earthing rods and cord winders.

Model No. (Order Code) **FT3151**

#### Basic specifications (Accuracy guaranteed for 1 year)

Measurement system	AC potentiometer method, Three-electrode method/ two-electrode method (switchable) Measuring frequency: 575 Hz/ 600 Hz Measurement current: Three-electrode method: 15 mA rms or less; Two-electrode method: 3 mA rms or less Open circuit voltage: 50 V AC rms or less		
Measurement range	10 Ω (0 to 11.5 Ω)	100 Ω (0 to 115 Ω)	1000 Ω (0 to 1150 Ω)
Nominal Deviation	±0.25 Ω	±2.5 Ω	±25 Ω
Functions	Auxiliary earth resistance check S (P)/ H(C)		
Earth potential measurement	0 to 30 V, Nominal Deviation: ±3.0 % f.s.		
Power supply	LR6 (AA) Alkaline battery ×6, 1100 times operation (at 30 sec. measurement/ 30 sec. rest cycle)		
Dimensions and mass	164 mm (6.46 in)W × 119 mm (4.69 in)H × 88 mm (3.46 in)D, 760 g (26.8 oz)		
Included accessories	Auxiliary Earthing Rod L9840 (2 piece set) ×1, Measuring cable L9841 (alligator clip, black 4 m (13.12 ft)), Measurement Cable L9842-11 (yellow 10 m (32.81 ft), equipped with winder), Measurement Cable L9842-22 (red 20 m (65.62 ft), equipped with winder) ×1, LR6 (AA) Alkaline battery ×6, Carrying Case C0106 ×1, Instruction manual ×1		

To ensure safety, use the optional Test Lead L9787 when making measurements using the two-electrode method.

Option	SHOULDER STRAP Z5022 (Photograph shows strap affixed to instrument)	Bundled Accessories				
		MEASUREMENT CABLE L9842-11 Yellow, 10 m (32.81 ft), equipped with winder	MEASUREMENT CABLE L9842-22 Red, 20 m (65.62 ft), equipped with winder	MEASUREMENT CABLE L9841 Black alligator clip, 4 m (13.12 ft) length	AUXILIARY EARTHING ROD L9840 2 piece set, stainless steel	CARRYING CASE C0106 Soft type, includes compartment for options
Options	L9844: for earthing terminal board, L9787: for two-electrode method, indoor use only					
	EARTH NETS 9050 Set of two, 30 cm (11.81 in) × 30 cm (11.81 in)	MEASUREMENT CABLE L9844 Red/yellow/black 1.2 m (3.94 ft) length	TEST LEAD L9787 Bundled with alligator clip, 1.2 m (3.94 ft) length	MEASUREMENT CABLE L9843-51 Yellow, 50 m (164.06 ft) length, equipped with flat cable winder	MEASUREMENT CABLE L9843-52 Red, 50 m (164.06 ft) length, equipped with flat cable winder	

## Non-Metallic Contact Voltage Detector with LED Light

### VOLTAGE DETECTOR 3481



White LED light illuminates dim locations.



CAT IV 600 V



- Non-contact detection of AC voltage from 40 V to 600 V with bright LED light
- Pen-style, compact detector with pocket clip
- Both visual and audible voltage detection indication
- Meets safety standards for CAT IV 600 V environments
- Prevent dead batteries with battery self-check function and auto power-off function

Model No. (Order Code) **3481-20**

#### Basic specifications

Measurement function	Voltage detection
Operating voltage range	40 V to 600 V AC (When brought into contact with a 2 mm <sup>2</sup> insulated cable equivalent to 600 V polyvinyl chloride insulated wire) Maximum sensitivity variable range 40 V to 80 V AC (80 V at the time of shipment)
Operating frequency	50 Hz/ 60 Hz
Pilot light	Red LED lights up and the buzzer sounds when the wire is live
Battery check	White LED is dim or out when the batteries are low.
Auto power off	The power will be turned off automatically if the instrument remains idle for 3 minutes after the power is turned on.
Power supply	LR44 button alkaline batteries ×3, Continuous use: 5 hr (Power ON standby state)
Dimensions and mass	20 mm (0.79 in)W × 126 mm (4.96 in)H × 15 mm (0.59 in)D (excluding projections), 30 g (1.1 oz) (including LR44 button alkaline batteries)
Included accessories	Instruction manual ×1, LR44 button alkaline batteries ×3 (for trial purposes only)

## Digital Phase Rotation Meter with Three-Phase Voltage Measurement Functionality

### DIGITAL PHASE DETECTOR PD3259-50



CAT IV 600 V



When Z3210 is installed

- Easily transfer measurement data to your smartphone or tablet by using our free app GENNECT Cross or to an Excel® file. (Wireless Adapter Z3210 is necessary)
- Available to check the unbalance rate and vector diagram in our free app GENNECT Cross
- World's first non-metallic contact voltage detection and testing
- Simply clip onto wire insulation
- Phase detection check and line-to-line voltage inspection at the same time
- Easy and intuitive phase detection check with backlight and buzzer
- Ideal for work certification photos, offering simultaneous display of phase sequence and 3-phase voltage

Model No. (Order Code) **PD3259-50** (Wireless Adapter Z3210 not included)  
**PD3259-90** (Bundled with the Wireless Adapter Z3210)

#### Basic specifications (Accuracy guaranteed for 1 year)

Detection functions	Positive phase, negative phase (Three-phase 3-wire, Three-phase 4-wire), open phase, prediction of ground phase (Three-phase 3-wire)
Measurement parameters	Three-phase AC voltage (line-to-line voltage and voltage to ground), Frequency • Voltage measurement accuracy: ±2.0% rdg. ±8 dgt., • Frequency measurement accuracy: ±0.5% rdg. ±1 dgt., • Response time: 3 s or less, Display update rate: 500 ms
Measurement targets	Covered cables, Metal portions *Use on shielded cables not supported Three-phase 90.0 to 520.0 V AC (45 to 66 Hz)
Diameter of measurable conductors	Finished outer diameter: 6 to 30 mm (0.24 to 1.18 in)
Maximum rated voltage to earth	600 V AC (CAT IV)
Environmental protection	Main unit (excluding voltage sensors): IP54 (EN60529) dustproof and waterproof
Other functions	Hold function, Backlight, Buzzer, Auto power-off, Low battery warning, Drop proof (on concrete, 1 m/ 1 time)
Power supply	AA alkaline batteries (LR6) ×4, Maximum rated power: 3 VA, Continuous operating time: 5 hours (Backlight off, standby state, Without Z3210)
Dimensions and mass	84 mm (3.31 in)W × 146 mm (5.75 in)H × 46 mm (1.81 in)D, 590 g (20.8 oz, including batteries), cord length: 0.5 m (1.64 ft)
Included accessories	AA alkaline batteries (LR6) ×4, Instruction manual ×1, Carrying case C0203 ×1, Color clip (White ×2, red ×2, blue ×2, yellow ×2), Spiral tubes (black ×1)

Note: Multi-core cables, thick cables, and dirty cables may not be measured accurately.



Bundled Accessory

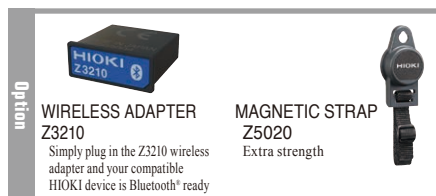

Option

**WIRELESS ADAPTER Z3210**  
Simply plug in the Z3210 wireless adapter and your compatible HIOKI device is Bluetooth® ready

**MAGNETIC STRAP Z5020**  
Extra strength



Software

**GENNECT Cross SF4071, SF4072**  
Mobile app for iOS, Android

## Easy-To-Read Arrow and No-Metal-Contact Clips for the Ultimate in Safety

### PHASE DETECTOR PD3129-10



- Simply clip clamps onto wire insulation
- Green LED arrow clearly shows phase direction, perfect for visual reports
- CAT III 1000V
- Rotating LED indicator shows the phase sequence for a 3-phase power supply at a glance
- Intermittent beeps signal positive phase; continuous tone signals reverse phase
- Magnetic base allows the instrument to be secured on a distribution panel

Model No. (Order Code) **PD3129-10** (Large clips)

#### Basic specifications

Functions	Phase detection (positive and negative)
Voltage detection method	Static induction
Voltage range	70 to 1000 V AC (50/60 Hz) (sine wave, continuous input)
Frequency range	45 Hz to 66 Hz
Object to be connected	7 mm (0.28 in) to 40 mm (1.57 in) of insulated wiring
Display	Phase detection : Positive ; 4 LEDs lit in clockwise order and the buzzer sounds intermittently, green arrow lights up Negative ; 4 LEDs lit in counterclockwise order and the buzzer sounds continuously
Battery check function	Power ON lamp: lights up (Power ON), blinks (Battery LOW)
Auto power off	Auto shut off if no activity is detected after power is turned ON for 15 minutes
Power supply	R6P (AA) manganese battery ×2, Continuous use: 70 hr
Dimensions and mass	70 mm (2.76 in)W × 75 mm (2.95 in)H × 30 mm (1.18 in)D, 240 g (8.5 oz), Cord length : 0.7 m (2.30 ft)
Included accessories	Carrying case ×1, Strap ×1, Spiral tube ×1, Instruction manual ×1, R6P (AA) manganese battery ×2

## Easy-To-Read Arrow and No-Metal-Contact Clips for the Ultimate in Safety

### PHASE DETECTOR PD3129



- Simply clip clamps onto wire insulation
- Green LED arrow clearly shows phase direction, perfect for visual reports
- Rotating LED indicator shows the phase sequence for a 3-phase power supply at a glance
- Intermittent beeps signal positive phase; continuous tone signals reverse phase
- Magnetic base allows the instrument to be secured on a distribution panel

Model No. (Order Code) **PD3129**

#### Basic specifications

Functions	Phase detection (positive and negative)
Voltage detection method	Static induction
Voltage range	70 to 600 V AC (50/60 Hz) (sine wave, continuous input)
Frequency range	45 Hz to 66 Hz
Object to be connected	2.4 mm (0.09 in) to 17 mm (0.67 in) of insulated wiring
Display	Phase detection : Positive ; 4 LEDs lit in clockwise order and the buzzer sounds intermittently, green arrow lights up Negative ; 4 LEDs lit in counterclockwise order and the buzzer sounds continuously
Battery check function	Power ON lamp: lights up (Power ON), blinks (Battery LOW)
Auto power off	Auto shut off if no activity is detected after power is turned ON for 15 minutes
Power supply	R6P (AA) manganese battery ×2, Continuous use: 70 hr
Dimensions and mass	70 mm (2.76 in)W × 75 mm (2.95 in)H × 30 mm (1.18 in)D, 200 g (7.1 oz), Cord length : 0.7 m (2.30 ft)
Included accessories	Carrying case ×1, Strap ×1, Spiral tube ×1, Instruction manual ×1, R6P (AA) manganese battery ×2

# Analog Meter Relays

## Advancing Power Saving and Automation METER RELAY 2103, 2104



Not CE Marked  
3 Year Warranty

- Ultra sensitive 1  $\mu$ A, 10 mV DC movement
- Includes a display lamp to illuminate movement at a glance
- Relay action delays circuit closure upon power on
- Both power circuitry and relay built-in
- \*H-type: Red LED lights up and output relay contact operates at deflection of the needle to the right of the setting needle
- \*L-type: Green LED lights up and output relay contact operates at deflection of the needle to the left of the setting needle
- \*HL-type: Provides functionality of both H- and L-type models

### When considering the purchase of Meter Relays:

- A Product Guide describing the specifications as well as a Meter Relay Specifications Check List are available.
- Please contact your local Hioki distributor or sales subsidiary for more information.

The Product Guide is also available for download at [www.hioki.com](http://www.hioki.com)

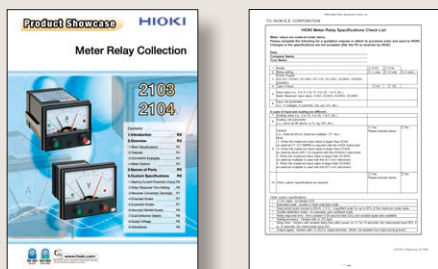

Model No. (Order Code)	2103H	(H type, upper-limit setting)
	2103L	(L type, lower-limit setting)
	2103HL	(HL type, upper/lower-limit setting)
	2104H	(H type, upper-limit setting)
	2104L	(H type, upper-limit setting)
	2104HL	(H type, upper-limit setting)

- 2.5 % class, Panel size: 84 mm (3.31 in): 2103H, 2103L, 2103HL
- 1.5 % class, Panel size: 104 mm (4.09 in): 2104H, 2104L, 2104HL

Note: These products are built-to-order so please confirm specifications and delivery time with your local HIOKI distributor.

### Basic specifications (Accuracy guaranteed for 1 year)

Indicator shape	$\phi$ 0.3 mm (0.01 in) pin
Accuracy class	[2103H/L/HL]: 2.5 %, [2104H/L/HL]: 1.5 %
Setting accuracy	Within 1.5 % of the full scale value (Independent of meter section)
Dead-zone width	Within 0.5 % of the scale length
Indicator operating range	Within the scale (passing indicator needle system)
Setting indicator (shape and color)	Spear shape H indicator (upper-limit side): Red, L indicator (lower-limit side): Green
Setting indicator setting range	Within the all range of scale for both H and L
Minimum H/L space	Within 3 % of the scale length
Delay time from power on	Approx. 2 s
Relay contact structure	One transfer for both H and L
Relay output response	Approx. 0.5 s (time constant)
Max. current of relay contact	5 A (Under condition of 250 V AC, 30 V DC, resistance load)
Power supply	100 V/200 VAC (to be specified at the time of ordering) 50/60 Hz, 3 VA max.

### Dimensions

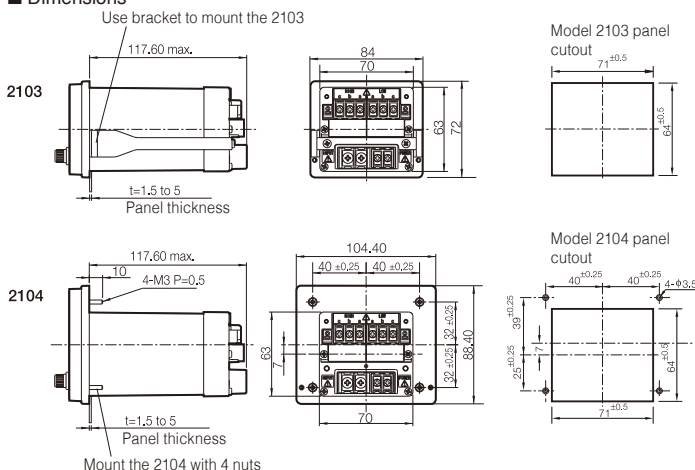

### Contact operation

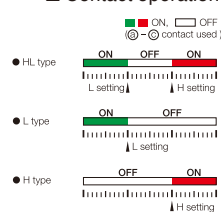

### Standard scale graduations

e.g. for full-scale value	Graduations	Graduation illustration
1, 10, 100	50	
1.5, 15, 150	30	
2, 20, 200	40	
2.5, 25, 250	50	
3, 30, 300	30	
4, 8, 40	40	
5, 50, 500	50	
6, 60, 600	30	
7.5, 75, 750	37.5	

### Standard Full-scale Values

DC Ammeter		DC Voltmeter		Rectifying AC ammeter		Rectifying AC voltmeter	
Standard full-scale value	Meter sensitivity spec.	Standard full-scale value	Meter sensitivity spec.	Standard full-scale value	Meter sensitivity spec.	Standard full-scale value	Meter sensitivity spec.
1 $\mu$ A	50 mV	10 mV	100 k $\Omega$ /V	200 $\mu$ A	50 mV	50 mV	10 k $\Omega$ /V
10 $\mu$ A		15 mV	100 k $\Omega$ /V	500 $\mu$ A		100 mV	10 k $\Omega$ /V
20 $\mu$ A		30 mV	100 k $\Omega$ /V	1 mA		150 mV	10 k $\Omega$ /V
50 $\mu$ A		50 mV*1	100 k $\Omega$ /V	2 mA		300 mV	10 k $\Omega$ /V
100 $\mu$ A		100 mV	100 k $\Omega$ /V	5 mA		500 mV	1 k $\Omega$ /V
200 $\mu$ A		150 mV	100 k $\Omega$ /V	10 mA		1 V	1 k $\Omega$ /V
500 $\mu$ A		300 mV	100 k $\Omega$ /V	20 mA		1.5 V	1 k $\Omega$ /V
1 mA		500 mV	10 k $\Omega$ /V	50 mA		3 V	1 k $\Omega$ /V
2 mA		1 V	10 k $\Omega$ /V	100 mA		5 V	1 k $\Omega$ /V
5 mA		1.5 V	10 k $\Omega$ /V	200 mA		10 V	1 k $\Omega$ /V
10 mA		3 V	10 k $\Omega$ /V	500 mA		15 V	1 k $\Omega$ /V
20 mA		5 V	10 k $\Omega$ /V	1 A		30 V	1 k $\Omega$ /V
50 mA	10 V	10 k $\Omega$ /V	2 A	50 V	1 k $\Omega$ /V		
100 mA	15 V	10 k $\Omega$ /V	3 A	100 V	1 k $\Omega$ /V		
200 mA	30 V	10 k $\Omega$ /V	5 A*2	150 V	1 k $\Omega$ /V		
500 mA	50 V	10 k $\Omega$ /V		300 V	1 k $\Omega$ /V		
1 A	100 V	10 k $\Omega$ /V					
2 A	150 V	10 k $\Omega$ /V					
5 A	300 V	10 k $\Omega$ /V					
20 A							
Magnified scale: 4 - 20 mA	50 mV	Magnified scale: 1 - 5 V	10 k $\Omega$ /V				

\*1. When the full-scale value is larger than 20 A DC, an external shunt device is used with the 50 mV instrument denoted by.

\*2. When the full-scale value is larger than 5 A AC, an external CT is used with the 5 A instrument denoted by.

- $\pm$ 1.5% class: For Model 2103
- Extended scale: Double or triple extended scale
- Segmented scale: Magnified scale for up to 40 % of the maximum scale value, exclusive 4-20 mA scale model, or 1-5 V scale model
- Double deflection meter: For example, zero-centered scale
- Relay response time: Time constant 0.05 second fixed (DC) and variable types also available
- Delay time: Version with variable delay time after power on. 0.1 to 10 seconds: (for instruments input DC), 2 to 12 seconds: (for instruments input AC)
- Output signal: Version with 1 V DC / f.s. output terminal
- \*Not isolated from input circuit ground.
- True RMS rectified with AC current meter, or AC voltage meter
- Specify a scale, or a unit

# Analog Meter Relays, CT/Shunts

## Expand Input Range for Use with Meter Relays (50/60 Hz, 1.0 % class)

### CURRENT TRANSFORMER CT-5MRN series



Not CE Marked

#### ■ Dimensions and connecting diagrams

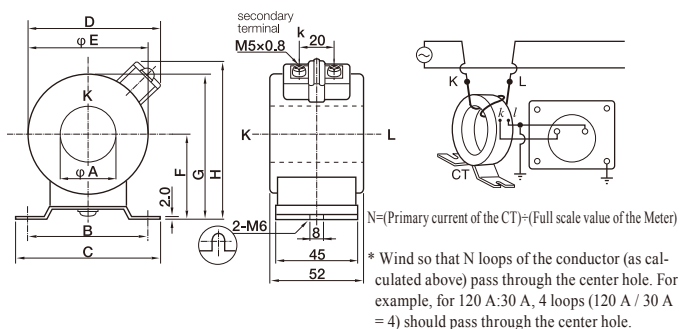

#### ■ Basic specifications

Model	Primary	Secondary	Rated load	Class	Max. rated voltage
CT-5MRN100	100 A	5 A	5 VA	1.0 %	1150 V
CT-5MRN120	120 A	5 A	5 VA	1.0 %	1150 V
CT-5MRN150	150 A	5 A	5 VA	1.0 %	1150 V

Model No. (Order Code)	<b>CT-5MRN100</b>	(Primary current 100 A, output 5 VA)
	<b>CT-5MRN120</b>	(Primary current 120 A, output 5 VA)
	<b>CT-5MRN150</b>	(Primary current 150 A, output 5 VA)

#### ■ Dimensions table

Symbol	φ A	B	C	D
Length	23 mm (0.91 in)	70 mm (2.76 in)	85 mm (3.35 in)	68 mm (2.68 in)

Symbol	φ E	F	G	H
Length	60 mm (2.36 in)	45 mm (1.77 in)	75 mm (2.95 in)	83 mm (3.27 in)

## Expand Current Range for Use with the 50 mV Full Scale Meter (50/60 Hz, 0.5 % class)

### EXTERNAL SHUNT HS-1 series



Not CE Marked

#### ■ Dimensions and connecting diagrams

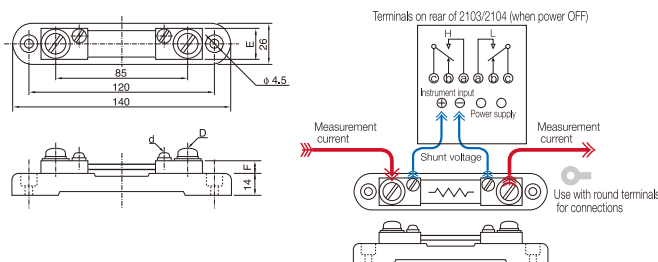

- Expand current range for the Meter Relay, or a switchboard meter
- Combination use with the 50 mV meter

#### ■ Basic specifications

Model	Rated current	Class
HS-1-30	30 A	±0.5 % at 80 % of rated current 60 °C or less around temperature
HS-1-50	50 A	
HS-1-75	75 A	
HS-1-100	100 A	
HS-1-150	150 A	
HS-1-200	200 A	
HS-1-300	300 A	±0.5 % at 0 A to 200 A ±1.0 % at 200 A to 240 A 60 °C or less around temperature

The total resistance of the connection cord must be 0.1 Ω or less

Model No. (Order Code)	<b>HS-1-30</b>	(30 A, class 0.5%)
	<b>HS-1-50</b>	(50 A, class 0.5%)
	<b>HS-1-75</b>	(75 A, class 0.5%)
	<b>HS-1-100</b>	(100 A, class 0.5%)
	<b>HS-1-150</b>	(150 A, class 0.5%)
	<b>HS-1-200</b>	(200 A, class 0.5%)
	<b>HS-1-300</b>	(300 A, class 1.0%)

Note: These products are built-to-order so please confirm specifications and delivery time with your local HIOKI distributor.

- \* Please note that connections' cores are not included. The total resistance of all shunt devices used should not exceed 0.1 Ω
- \* If product includes an instrument number or is packaged with an instrument, use in combination with that instrument
- \* Select a model such that input does not exceed 80 % of the rating. (0.5 accuracy definition requirements: 80 % or less of rated input, ambient temperature of 60 °C or less)

#### ■ Dimensions table

Symbol	E	F	d	D
HS-1-30	20 mm (0.79 in)	6 mm (0.24 in)	M4 mm	M5 mm
HS-1-50	20 mm (0.79 in)	8 mm (0.31 in)	M4 mm	M8 mm
HS-1-75	20 mm (0.79 in)	8 mm (0.31 in)	M4 mm	M8 mm
HS-1-100	20 mm (0.79 in)	15 mm (0.59 in)	M5 mm	M8 mm
HS-1-150	20 mm (0.79 in)	15 mm (0.59 in)	M5 mm	M8 mm
HS-1-200	25 mm (0.98 in)	15 mm (0.59 in)	M5 mm	M10 mm
HS-1-300	25 mm (0.98 in)	15 mm (0.59 in)	M5 mm	M10 mm

## Free App for Easy Instrument Connectivity, Data Recording, and Report Creation

### GENNECT Cross SF4071, SF4072

GENNECT Cross



Share data via the GENNECT Cloud

- Connect instruments to your smart phone or tablet
- Save all measured values on your smart phone
- Use the logging function to save measured values automatically at a set interval
- Use the simple oscilloscope function to view current and voltage waveforms on your smart phone (CM/DT series, etc.)
- Continuously measure the internal resistance and voltage of lead-acid batteries (BT3554-50 series only)

Model No. (Order Code)	<b>SF4072</b>	(Mobile app for Android)	Free
	<b>SF4071</b>	(Mobile app for iOS)	Free

■ Data can be downloaded to tablets and smartphones using Hioki's dedicated apps available from the Google Play or App Store. Search for "HIOKI" and download the "GENNECT Cross" app.



\*Android, Google Play and the Google Play logo are trademarks of Google Inc.  
 \*iOS is a registered trademark of Cisco Technology, Inc. and/or its affiliates in the United States and certain other countries.  
 \*iPhone, iPad, iPad mini, iPad Pro and iPod touch are trademarks of Apple Inc.  
 \*Apple and the Apple logo are trademarks of Apple Inc. App Store is a service mark of Apple Inc.  
 \*Microsoft, Windows, Windows Vista, and Excel are either registered trademarks or trademarks of Microsoft Corporation in the United States and/or other countries.  
 \*Company names and Product names appearing in this catalog are trademarks or registered trademarks of various companies.  
 \*The Bluetooth® word mark and logos are registered trademarks owned by Bluetooth SIG, Inc. and any use of such marks by HIOKI E.E. CORPORATION is under license.  
 \*For the latest information about countries and regions where wireless operation is currently supported, please visit the Hioki website.

#### ■ SF4071, SF4072 Basic specifications (Free software)

Bluetooth® connection	Bluetooth® LE
OS which GENNECT Cross can be installed	SF4071: iOS 10.0 or later, iPadOS 13.0 or later SF4072: Android™ 5.0 or later
Measurement data management	Local, e-mail / cloud sharing
Report function	Various template reports
Picture / Memo recording	Ok
Measurement functions	General measurement: Ok Logging: Ok Pass/Faile judge: Ok Photo/Drawing with Values Measurement: Ok Waveform display: CM/DT series, etc. Battery: BT3554-50 series only Detect electricity theft: CM3286-50 only Harmonic measurement: CM/DT series compatible with Z3210, etc. Lux measurement: FT3425 only Event Recording: CM/DT series compatible with Z3210, etc. Vector Measurement: PD3259-50 only  The above is an example. For details, please refer to the catalogs and web-sites of compatible products.  Firmware upgrade for measuring instruments: Measurement instruments compatible with Z3210

\*For the latest information about countries and regions where wireless operation is currently supported, please visit the Hioki website.

Z3210 is required for Bluetooth® function		Built-in Bluetooth® function	
	AC/DC CLAMP METER CM4371-50, CM4373-50, CM4375-50		AC CLAMP METER CM4141-50
	AC CLAMP POWER METER CM3286-50		LUX METER FT3425
	AC LEAKAGE CLAMP METER CM4001, CM4002, CM4003		CLAMP ON EARTH TESTER FT6380-50
	DIGITAL MULTIMETER DT4261		DISPLAY UNIT CM7291
	EARTH TESTER FT6031-50		DIGITAL PHASE DETECTOR PD3259-50
	INSULATION TESTER IR4057-50		BATTERY TESTER BT3554-50 series
	BYPASS DIODE TESTER FT4310		

## Get connected to create and share graphical reports in a flash!

### WIRELESS ADAPTER Z3210



#### ■ Basic specifications

Operating environment	Indoors, pollution degree 2, operable at an altitude specified in specifications of each measuring instrument to which the adapter is attached
Operating temperature and humidity (Storage temperature and humidity)	-30°C (-22°F) to 70°C (158°F), 90% RH or less (no condensation)
Standards	Safety: EN61010 RF: EN300 328 RF EMC: EN301 489-1, EN301 489-17 Exposure: EN62479
Maximum attaching/detaching count	5000 times
GENNECT Cross App confirmed compatible OSs	iOS 13 or later, Android 8 or later, Bluetooth® 4.0 or later
Bluetooth® communication distance	About 10 m (line-of-sight distance)
Product warranty period	3 years (do not exceed the maximum attaching/detaching count)
Dimensions and mass	Approx. 16.4 mm (0.65in)W × 6.7 mm (0.26in)H × 15.6 mm (0.61in)D, 1.5 g (0.05 oz.)
Included accessory	Instruction manual

- Increase your work efficiency, by eliminating human errors from manual reporting
- Transfer readings on instruments to easy-to-read graphical reports to prove integrity
- Increase your work productivity & save costs!
- Provide additional new functions for Hioki instruments such as waveform display & more!
- Compliance with wireless regulations in more than 50 countries and regions

Model No. (Order Code) **Z3210**

Note) Z3210 cannot be used by itself. Wireless communication will be possible by connecting to a compatible measuring instrument.

\*For the latest information about countries and regions where wireless operation is currently supported, please visit the Hioki website.

	AC/DC CLAMP METER CM4371-50, CM4373-50, CM4375-50		AC CLAMP METER CM4141-50		AC CLAMP POWER METER CM3286-50		AC LEAKAGE CLAMP METER CM4001, CM4002, CM4003
	CLAMP ON EARTH TESTER FT6380-50		DIGITAL MULTIMETER DT4261		EARTH TESTER FT6031-50		DIGITAL PHASE DETECTOR PD3259-50
	INSULATION TESTER IR4057-50		BATTERY TESTER BT3554-50 series				



## Get Results from the Job Site in Real-Time & Capture Data on the PC while Testing Remotely

### GENNECT One SF4000

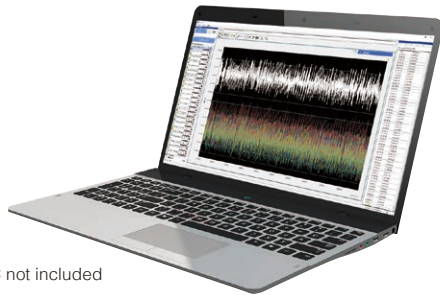

PC not included

- Connect measuring instruments to a PC via a LAN cable
- Acquire measurement values from multiple measuring instruments at regular intervals and display them on a graph in real time. \*1
- Lay out measurement values on the image and able to check graphically \*1
- Operate measuring instruments connected via LAN from a PC \*2
- Automatically transfer files saved on a LAN-connected measuring instrument to a PC \*3
- Software automatically recognizes LAN-connected measuring instrument
- Manage and save results with software
- List MAX, MIN and AVG values (Display time of MAX & MIN data)
- Real-time calculation of measurement values of arbitrary measurement items (calculation between channels)
- Automatically output measurement data to daily/weekly/monthly report or CSV file

\*1 Max. number of connections: 30 units, The measurement value (current location) displayed by the instrument is acquired at a fixed interval (minimum 1 second) by the PC timer.

\*2 Max. number of connections: 30 units

\*3 Max. number of connections: 15 units

Model No. (Order Code) **SF4000** (Application for Windows) Free

#### ■ Basic specifications (Free software)

[Logging]	
Functions	Graph and list displays that present measured values from LAN-connected instruments in real time * Acquire measured values (current values) displayed on instruments at a set interval (as short as 1 sec.) using the computer's timer.
Logging intervals	1, 2, 5, 10, 30 sec. / 1, 2, 5, 10, 30 min. / 1 hour
Number of log items	Max. 512 items + 16 items (calculation between channels) *Maximum 32 items when simultaneously displaying graphs
Recording time	Recording time: Continuous measurement, set time File segmentation: 1 day, 1 hour Logging stops when the storage capacity of the PC is below 512 MB
[Dashboard]	
Functions	Display measured values from LAN-connected measuring instruments on optional backgrounds of monitors and alarms * Acquire measured values (current values) displayed on instruments at a set interval (as short as 1 sec.) according to the computer's timer.
Monitoring intervals	1, 2, 5, 10, 30 sec. / 1, 2, 5, 10, 30 min. / 1 hour
Number of measured parameters	Max. 512 items + 16 items (calculation between channels)
[Remote control]	
Functions	Control LAN-connected instruments from a computer
[File transfer (Manual)]	
Functions	Acquire files stored in LAN-connected instruments from a PC The BT3554-50 series can be acquired via USB.
[File transfer (Automatic)]	
Functions	Automatically send files saved by LAN-connected instruments to a computer.
[Other functions]	
Instrument clock synchronization	Set the clocks of measuring instruments connected via LAN to the PC (manual, automatic)
Files loading	Data file obtained by GENNECT Cross for iOS/Android Note: Logging, General Measurement, image and battery formats only Note: No direct Bluetooth® connection is possible, please use the smartphone app for Bluetooth® data collection Data acquired by GENNECT Remote
Others	CSV output (battery, logging), data statistics (logging), report generation (battery, logging)

Compatible products

POWER ANALYZER  
PW6001  
PW3390

POWER ANALYZER  
PW8001

POWER METER  
PW3335  
PW3336  
PW3337

POWER QUALITY ANALYZER  
PQ3100  
PQ3198

CLAMP ON POWER LOGGER  
PW3360  
PW3365

MEMORY HILOGGER  
LR8450 series  
LR8410, LR8416,  
LR8400 series

MEMORY HICORDER  
MR6000

BATTERY TESTER  
BT3554-50 series



## Cloud service for the GENNECT series

### GENNECT Cloud SF4180

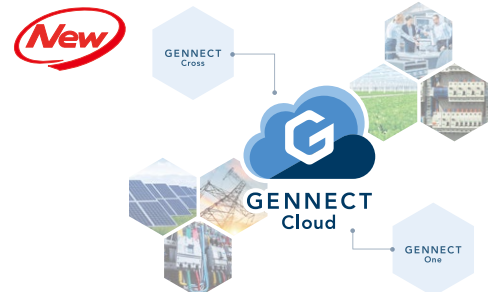

- Connects to the GENNECT series to provides added value through cloud services
- Makes measurement more convenient with features like exchanging data via the cloud and enabling remote measurement
- Offers a range of plans and payment methods

Model No. (Order Code)	SF4180	(Free plan with basic functions)	Free
<b>SF4181-01</b>	(GENNECT Cloud Standard 1 month license)	Fees apply	
<b>SF4181-03</b>	(GENNECT Cloud Standard 3 months license)	Fees apply	
<b>SF4181-12</b>	(GENNECT Cloud Standard 12 months license)	Fees apply	
<b>SF4182-01</b>	(GENNECT Cloud Pro 1 month license)	Fees apply	
<b>SF4182-03</b>	(GENNECT Cloud Pro 3 months license)	Fees apply	
<b>SF4182-12</b>	(GENNECT Cloud Pro 12 months license)	Fees apply	

#### ■ Basic specifications

	Trial (Free, usage limited to 3 months)	Free (Free)	Standard (Fees apply)	Pro (Fees apply)
Monitor function	Collect and save GENNECT polled data (logged at a 1 min. interval) and display it in real time.			
Drive functionality	Manage and export GENNECT polled data and instrument data files.			
Alarm function	Alarm notification destinations: Email, Microsoft Teams, Slack, LINE, GENNECT Cross			
Console function	-	-	Control instruments remotely (not supported by GENNECT Cross)	
Cloud storage space	500 MB	5 GB	50 GB	500 GB
No. of users / No. of teams / No. of measurement groups	1 / 0 / 1	3 / 3 / 1	10	100
Max. no. of alarms per measurement group	1	3	30	100
WebAPI use	No	No	No	Yes

You can also set up automatic ongoing payments (a subscription) by credit card.

## Fully Automated Transmission Coil Evaluation of WPT, High-Speed Measurement System of 3000 Points/Hour

### WPT TEST SYSTEM TS2400

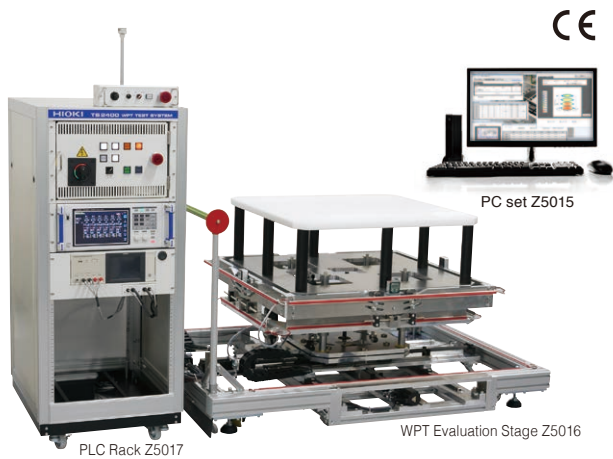

- Combines a measurement unit with an XYZ stage for high-speed analysis of multi-model, multi-point measurement results
- Generates four types of characteristics graphs in real time, even while testing is still in progress
- Features a large, 900 mm stage designed for use with automotive magnetic resonance devices
- Can position transmission coils with a radius of up to 800 mm
- Incorporates POWER ANALYZER PW6001 to measure power transmission efficiency
- Incorporates IMPEDANCE ANALYZER IM3570 to measure combined coefficients automatically

Model No. (Order Code) **TS2400** (System product)

#### ■ TS2400 Basic specifications

Setup	Standard set: Z5015 + Z5016 + Z5017 + Z5018, Measuring instruments: PW6001, IM3570 (IM3536), LR8410, FT3470 Basic set: Z5015 + Z5016 + Z5017, Measuring instruments: PW6001, LR8431, FT3470 Data analysis: Z5015 only (no measuring instruments)
-------	--

#### ■ PC set Z5015 Basic specifications

Operating environment	Microsoft Windows 10 Professional (64bit)
Installed software	WPT Evaluation Software SF2400
Data collection item	PW6001: Selected optionally from all measurement parameters, IM3570 (IM3536): Inductance, Capacitance, DC resistance, Impedance, Z5016: Each axial coordinate, etc.
Functions	Data collection, Control equipment, Calculation (coupling coefficient, etc.), Graph generation (Smith chart, etc.)
Power supply	100 V to 240 V AC, 50/60 Hz, 180 VA (supplied by PLC Rack Z5017)
Dimensions and mass	180 mm (7.09 in)W × 33 mm (1.3 in)H × 121 mm (4.76 in)D, 0.8 kg (28.2 oz)
Included accessories	License key (USB) ×1, Recovery media (USB) ×1, keyboard ×1, mouse ×1, AC adapter ×1, monitor ×2, Instruction manual ×1

#### ■ WPT Evaluation Stage Z5016/PLC Rack Z5017 Basic specifications

Functions	XYZ axis automatic control, output a power supply
Movable range	X-axis Y-axis: ±300 mm, Z-axis: ±100 mm
Target workspace	Max. 800 mm (31.5 in)W × 70 mm (2.76 in)H × 800 mm (31.5 in)D, 100 kg (3527.4 oz)
Power supply	Single phase 200 V/220 V/230 V/240 V (specify at time of order), 50/60 Hz, 3 kVA
Dimensions and mass	Z5016: 1600 mm (62.99 in)W × 900 mm (35.43 in)H × 1200 mm (47.24 in)D, 350 kg (12345.9 oz) Z5017: 570 mm (22.44 in)W × 1250 mm (49.21 in)H × 710 mm (27.95 in)D, 100 kg (3527.4 oz)

#### ■ Switching Box Z5018 Basic specifications

Measurement terminal	Two terminal clip ×2
Other	Built-in PLC rack Z5017, characteristic impedance: 50 Ω, connectable model: IM3570, IM3536 (Accuracy guarantee valid only for Model IM3570.)

## By synergizing complementary technologies, HIOKI delivers solutions that fully meet next-generation needs.

Ours is a global era underpinned by state-of-the-art electronic technologies. HIOKI's bare board testing systems and populated board testing systems are hard at work in plants that manufacture printed circuit boards with increasingly advanced, high-density designs. HIOKI's printed circuit board testing systems are an ideal choice for manufacturing plants seeking to achieve rational production through high precision, reliability, and ease of use and for companies striving to ship products with the world's fastest cycle times.

With product series ranging from flying probe systems designed to test small lots of boards representing multiple models to bed-of-nails systems engineered for use with mass-produced boards, HIOKI's ATE offerings deliver optimized functionality and cost performance for bare board and populated board testing processes. HIOKI's printed circuit board testing systems, which can accommodate BGAs, CSPs, boards with embedded passive and active devices, and silicon interposers, continue to evolve. We invite you to put them to work in your own demanding applications.

### Bare Board and Package Testing



■ FLYING PROBE TESTER FA1283

**New** ■ FLYING PROBE TESTER FA1813

■ FLYING PROBE TESTER FA1816

■ FLYING PROBE TESTER FA1817

■ FLYING PROBE TESTER FA1811

### Populated Board Testing



■ IN-CIRCUIT TESTER FA1220-11

**New** ■ IN-CIRCUIT TESTER FA1220-02

■ FLYING PROBE TESTER FA1240-60 series

■ SHORT-OPEN TESTER FA1221

Computer and peripherals not included in FA1220. A separate control computer is required in order to use the FA1220 on a standalone basis.

■ IN-CIRCUIT TESTER FA1220

## Significantly lower testing costs while maintaining high-speed performance

### FLYING PROBE TESTER FA1816



- High-speed pattern testing using the capacitive measurement method
- Reduce probe marks in combination with the latest probes
- Significantly improved operability

Model No. (Order Code) **FA1816** (Horizontal single sided)

#### ■ Specifications Overview

Number of arms	2 (top surface × 2)	
Compatible probes	1172 series, CP1072 series	
Number of test steps	999,999 steps	
Test parameters and measurement ranges	Resistance measurement :	40.00 μΩ to 40.00 MΩ
	Insulation measurement :	1.000 kΩ to 500.0 MΩ
	Capacitance measurement :	100.0 fF to 10.00 μF
	Leakage current measurement :	1.000 μA to 10.00 mA
	High-voltage resistance measurement :	1.000 kΩ to 500.0 MΩ
	Capacitor insulation measurement :	1.000 kΩ to 10.00 MΩ
	Open measurement :	4.000 Ω to 4.000 MΩ
	Short measurement :	400.0 mΩ to 40.00 kΩ
Judgment range	-99.9% to +999.9% or absolute value	
Minimum pad pitch	40 μm (with CP1075-09)	
Minimum pad size	10 μm (with CP1075-09)	
Measurement speed	Max. 100 points/sec. (0.1 mm movements, 2-arm simultaneous probing, capacitance measurement)	
Testable boards	50 mm (1.97 in) W × 50 mm (1.97 in) D to 610 mm (24.02 in) W × 510 mm (20.08 in) D, Thickness 0.1 mm (0.004 in) to 3.2 mm (0.13 in)	
Maximum testable area	610 mm (24.02 in) W × 510 mm (20.08 in) D	
Power supply	200 V, 220 V, 230 V, 240 V AC single phase (specify at time of order), 50 Hz/ 60 Hz, Maximum power consumption: 3 kVA	
Dimensions and mass	1303 mm (51.30 in) W × 1194 mm (47.01 in) H × 1167 mm (45.94 in) D (excluding protruding parts), 900 kg (31746 oz)	

## Detect Latent Defects on High-Density Printed Wiring Boards with Absolute Reliability

### FLYING PROBE TESTER FA1817



Vertical and both sides

- Optimization of probe movement reduces inspection time by up to 20%
- Reduce probe marks in combination with the latest probes
- Fault analysis using newly developed "Process Analyzer"

Model No. (Order Code) **FA1817** (Vertical double sided)

#### ■ Specifications Overview

Number of arms	4 (front × 2, rear × 2)	
Compatible probes	1172 series, CP1072 series	
Number of test steps	999,999 steps	
Test parameters and measurement ranges	Resistance measurement :	40.00 μΩ to 40.00 MΩ
	Insulation measurement :	1.000 kΩ to 100.0 GΩ
	Capacitance measurement :	100.0 fF to 10.00 μF
	Leakage current measurement :	1.000 μA to 10.00 mA
	High-voltage resistance measurement :	1.000 kΩ to 100.0 GΩ
	Capacitor insulation measurement :	1.000 kΩ to 10.00 MΩ
	Open measurement :	4.000 Ω to 4.000 MΩ
	Short measurement :	400.0 mΩ to 40.00 kΩ
Judgment range	-99.9% to +999.9% or absolute value	
Minimum pad pitch	45 μm (with CP1075-09)	
Minimum pad size	15 μm (with CP1075-09)	
Measurement speed	Max. 67 points/sec. (0.15 mm movements, 4-arm simultaneous probing, capacitance measurement)	
Testable boards	Standard specification: 50 mm (1.97 in) W × 50 mm (1.97 in) H to 610 mm (24.02 in) W × 510 mm (20.08 in) H, Thickness 1.0 mm (0.04 in) to 3.2 mm (0.13 in)	
	Pneumatic board clamp (option): 50 mm (1.97 in) W × 70 mm (2.76 in) H to 610 mm (24.02 in) W × 510 mm (20.08 in) H, Thickness: 0.6 mm (0.02 in) to 6.0 mm (0.24 in)	
Maximum testable area	604 mm (23.78 in) W × 504 mm (19.84 in) H	
Power supply	200 V, 220 V, 230 V, 240 V AC single-phase (specify at time of order), 50 Hz/ 60 Hz, Maximum power consumption: 3 kVA	
Dimensions and mass	1485 mm (58.46 in) W × 1950 mm (76.77 in) H × 800 mm (31.50 in) D, (excluding protruding parts), 1070 kg (37742.5 oz)	

Installation area: FA1817 can inspect boards (610 × 510 mm) of the same size as the conventional Model 1271, but the installation area for the equipment is even smaller than the conventional Model 1270 (inspection board size is smaller than on the 1271), contributing to space saving measures. In addition, a back door is available as an option, supporting easier maintenance.

# Bare Board and Package Testing

## Complete Electrical Testing of High-Function Boards with a Single Unit. Max. 100 points/sec.

### FLYING PROBE TESTER FA1283



Horizontal and both sides

- 15 μm square high precision contact and high speed probing
- Max.100 points/s ultra-high speed inspection
- Inspect general bareboards to fine and high density substrates such as flexible substrate and CSP
- Full lineup of functions including capacitance measurement and testing of diodes and other embedded components

Model No. (Order Code) **FA1283-01** (without board-carrier)  
**FA1283-11** (with board-carrier)

#### Specifications Overview

Number of arms	4 (2 each, top and bottom)	
Mountable probes	I172 series	
Number of test steps	Max. 900,000 steps	
Measurement parameters and measurement ranges	Resistance :	40.00 μΩ to 100.0 MΩ
	Capacitance :	10.00 fF to 40.00 mF
	Inductance :	10.00 μH to 100.0 mH
	Diode VZ measurement :	0.000 V to 25.00 V
	Insulation resistance :	200.0 Ω to 100.0 GΩ
	Capacitance Insulation resistance :	200.0 Ω to 10.00 MΩ
	High voltage resistance :	200.0 Ω to 25.00 GΩ
	High voltage short resistance :	400.0 mΩ to 400.0 kΩ
	Leak current measurement :	100.0 nA to 10.00 mA
	Zener diode VZ measurement :	0.000 V to 25.00 V
	Digital transistor measurement :	0.000 V to 25.00 V
	Photo couplers measurement :	0.000 V to 25.00 V
	Continuity test :	400 mΩ to 1.000 kΩ
Open test :	4.000 Ω to 4.000 MΩ	
Short test :	400.0 mΩ to 40.00 kΩ	
DC voltage measurement :	40.00 mV to 25.00 V	
Judgment range	-99.9% to +999.9% or absolute value	
Overall probing precision	20 μm (Square)/ 15 μm (Square) (when using FA1971-01)	
Measurement speed	Max. 100 points/ s (X-Y movements of 0.1 mm, 2-arm simultaneous probing, when capacitance measurement)	
Testable board size	Thickness : 0.1 mm to 2.5 mm (0.10 in) Outer dimensions : 50 mm (1.97 in) W × 50 mm (1.97 in) D to 400 mm (15.75 in) W × 330 mm (12.99 in) D	
Maximum testable area	400 mm (15.75 in) W × 324 mm (12.76 in) D	
Board clamping	Board 2-side chuck method (with tension function)	
Power supply	200 V, 220 V, 230 V, 240 V AC single-phase (specify at time of order), 50/60 Hz, 5 kVA	
Dimensions and mass	1360 mm (53.54 in) W × 1200 mm (47.24 in) H × 1280 mm (50.39 in) D, (Excluding protruding parts), 1,100 kg (38,800.7 oz)	

## 1/2 Data Generation Time With New Platform, 3-in-1 Editing Software for Bare Board Testing

### FEB-LINE INSPECTION DATA CREATION SYSTEM UA1781

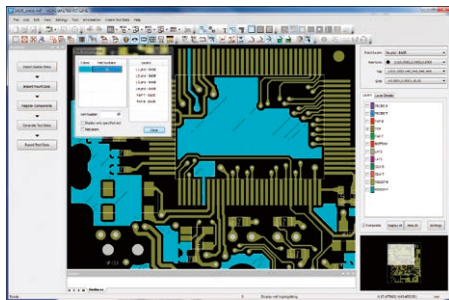

Gerber editing software that embodies the know-how for substrate testing

Built-in commands eliminate need for special know-how

- Easily generate test points even on the inner layer for cavity structures (One-point test-point generation)
- Expanded touch panel functions for printed boards (Optional E7001)
- Support for built-in component boards
- High-precision relay-point deletion functionality that reliably delete only the unnecessary relay-points

Model No. (Order Code) **UA1781** (Permanent license version)

#### Specifications Overview

License content	Install CD, license key (USB), instruction manual *Note: Please purchase hardware such as PC and monitor separately.
Supported OS	Windows 10 Pro 64-bit
Data entry function	Gerber file, aperture file, drill file, U-ART database, DXF (optional E7001)
Test data generation function	Net information generation, part test data generation, test point generation, relay-point deletion
Test data output format	SFD, SFDX, NND, IND, CON, COT, COTX, PRTX, LAYOUT

#### Options

Model No. (Order Code)	Product Name	Remarks
Options		
<b>E7001</b>	FEB-LINE TOUCH PANEL DESIGN EXTENSION SOFTWARE	For the UA1781
<b>E7002</b>	FEB-LINE TEST FIXTURE FUNCTION SOFTWARE	For the UA1781

Note: Inquire separately about setup of the E7002.

## Evaluate high-density package board reliability with super-high-precision probing

### FLYING PROBE TESTER FA1813

**New**



- Four-terminal measurement with a minimum pad diameter of 28  $\mu\text{m}$
- Reduce probe marks in combination with the latest probes
- Defect analysis using Hioki's Process Analyzer

Model No. (Order Code) **FA1813** (Horizontal double sided)

#### ■ Specifications Overview

Number of arms	4 (2 each, top and bottom)
Compatible probes	1172 series, CP1072 series, CP1073 series
Number of test steps	999,999 steps
Test parameters and measurement ranges	DC constant-current continuity measurement: 400.0 $\mu\Omega$ to 400.0 k $\Omega$ DC constant-current resistance measurement: 40.00 $\mu\Omega$ to 400.0 k $\Omega$ DC constant-voltage resistance measurement: 4.000 $\Omega$ to 40.00 M $\Omega$ Insulation resistance measurement: 1.000 k $\Omega$ to 100.0 G $\Omega$ AC constant-voltage capacitance measurement: 100.0 fF to 10.00 $\mu\text{F}$ Leakage current measurement: 1.000 $\mu\text{A}$ to 10.00 mA High-voltage resistance measurement: 1.000 k $\Omega$ to 100.0 G $\Omega$ Capacitor insulation measurement: 1.000 k $\Omega$ to 10.00 M $\Omega$ Open measurement: 4.000 $\Omega$ to 4.000 M $\Omega$ Short measurement: 400.0 m $\Omega$ to 40.00 k $\Omega$
<Embedded device board test>	LSI Connection test: 0.000 V to 12.00 V LSI Consumption current test: 100.0 nA to 100.0 mA AC constant-voltage resistance measurement: 10.00 $\Omega$ to 10.00 k $\Omega$ AC constant-voltage capacitance measurement: 10.00 pF to 100.0 $\mu\text{F}$ AC constant-voltage inductance measurement: 1.000 $\mu\text{H}$ to 1.000 mH
Judgment range	-99.9% to +999.9% or absolute value
Movement resolution	XY: 0.1 $\mu\text{m}$ / pulse; Z: 1 $\mu\text{m}$ / pulse
Minimum pad pitch	Top surface: 32 $\mu\text{m}$ (with CP1075-09) Bottom surface: 44 $\mu\text{m}$ (with CP1075-09)
Minimum pad size	Top surface: 2 $\mu\text{m}$ (with CP1075-09) Bottom surface: 14 $\mu\text{m}$ (with CP1075-09)
Measurement speed	Max. 76 points/sec. (0.5 mm movements, 4-arm simultaneous probing, capacitance measurement)
Testable board size	Thickness: 0.1 mm to 2.5 mm (0.10 in) Outer dimensions: 50 mm (1.97 in) W $\times$ 50 mm (1.97 in) D to 400 mm (15.75 in) W $\times$ 330 mm (12.99 in) D
Maximum testable area	398 mm (15.67 in) W $\times$ 304 mm (11.97 in) D
Clamp method	2-side holder
Power supply	200 V, 220 V, 230 V, 240 V AC single phase (specified at time of order), 50 Hz/ 60 Hz, Maximum power consumption: 5 kVA
Dimensions and weight	1355 mm (53.35 in) W $\times$ 1200 mm (47.24 in) H $\times$ 1265mm (49.8 in) D (excluding protruding parts), 1130 kg (39860 oz)

## Meeting Ever Increasing Demands for Greater Analytical Power, Faster Testing Speeds and Reduced Costs

### FLYING PROBE TESTER FA1811

Not CE Marked



- Achieve both high precision contact and high-speed probing in a space of 10  $\mu\text{m}$ .
- Double test method delivers an operation rate of 100%.
- Full-net insulation continuity test using resistance: x10 max. speed\*
- High-speed test using capacitance: x2 max. speed\*

(\* Compared to the double-sided 4-arm FLYING PROBE TESTER)

Model No. (Order Code) **FA1811** (4096 channels built-in)

Testing requires either the CP1165-11 or the E4101.

#### ■ TEST FIXTURE CP1165-11 Specifications

Board dimensions	Square 10 mm (0.39 in) to Square 80 mm (3.15 in)
Supported range of board thicknesses for clamping	0.1 mm (0.004 in) to 5.0 mm (0.20 in)
Notes	Designed for each board
Board clamping	Holder, shutter, and vacuum pump required separately
Supported pad diameter	200 $\mu\text{m}$ or larger, 300 $\mu\text{m}$ or larger when using Kelvin probe
Max. number of pins	8192

#### ■ Specifications Overview

Number of arms	2 (Upper: 2)
Mountable probes	CP1073 series
Measurement parameters and measurement ranges	Resistance measurement: 400.0 $\mu\Omega$ to 40.00 M $\Omega$ 4.000 $\Omega$ to 4.000 M $\Omega$ (T) Capacitance measurement: 100.0 fF to 10.00 $\mu\text{F}$ MLCC measurement: 100.0 nF to 100.0 $\mu\text{F}$ Insulation measurement: 1.000 k $\Omega$ to 100.0 G $\Omega$ 1.000 k $\Omega$ to 250.0 M $\Omega$ (T) Capacitor insulation measurement: 1.000 k $\Omega$ to 10.00 M $\Omega$ High-voltage resistance measurement: 1.000 k $\Omega$ to 100.0 G $\Omega$ 1.000 k $\Omega$ to 250.0 M $\Omega$ (T) Leak current measurement: 1.000 $\mu\text{A}$ to 10.00 mA Continuity: 400 m $\Omega$ to 1.000 k $\Omega$ Open measurement: 4.000 $\Omega$ to 4.000 M $\Omega$ Short measurement: 400.0 m $\Omega$ to 40.00 k $\Omega$ (T): When measuring via the TEST FIXTURE
Judgment range	-99.9% to +999.9% or absolute value
Total probing precision	10 $\mu\text{m}$ (Square)
Probing pitch	Min. 40 $\mu\text{m}$ (when using CP1073-01)
Supported range of board thicknesses for clamping	Follow option on BGA side
Probing area	75 mm (2.95 in) $\times$ 75 mm (2.95 in)
Power supply	200 V AC $\pm$ 10% (three phase) 50/60 Hz (200 V, 220 V AC: specify at time of order) Maximum power consumption: 5 kVA
Dimensions and mass	1300 mm (51.18 in) W $\times$ 1670 mm (65.75 in) H $\times$ 1700 mm (66.93 in) D (Excluding protruding parts), 2000 kg (70,546.7 oz)

#### ■ VACUUM UNIT FOR CAPACITANCE TEST E4101 Specifications

Board dimensions	50 mm (1.97 in) W $\times$ 90 mm (3.54 in) D to 105 mm (4.13 in) $\times$ 250 mm (9.84 in)
Supported range of board thicknesses for clamping	0.1 mm (0.004 in) to 0.8 mm (0.031 in)
Notes	To accommodate the entire range of substrate thickness, it is necessary to replace the spacer for substrate thickness adjustment.
Board clamping	VACUUM PUMP E4106 required separately

## Data Analysis Software for Detecting Latent Defects on PASS Boards

### DATA ANALYSIS SOFTWARE UA1801

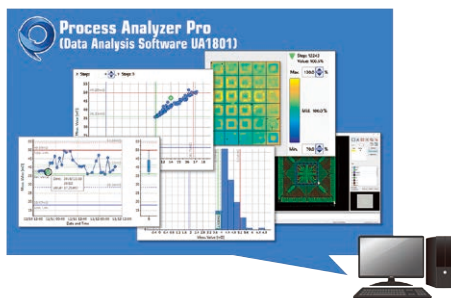

#### Detect Latent Defects Hidden in PASS Boards

- Perform statistical analysis using the latest AI technologies
- Detect significant points that can cause latent defects
- Provide feedback to improve quality in board production and design processes

Model No. (Order Code) **UA1801-01** (Limited 1-year license)  
**UA1801-02** (Unlimited license)

Download the free version of Process Analyzer here.  
Note: The Pro and free versions use the same application file. To access Pro features, you must purchase a license key.  
[https://www.hioki.com/e/lp/2020fa1817\\_pa/](https://www.hioki.com/e/lp/2020fa1817_pa/)



#### Specifications Overview

License contents	License key (USB) only *Note: Please purchase computer, display and other hardware separately and download the installer and documentation from Hioki's website.
Supported test equipment	FA1813, FA1817, FA1816, FA1811, FA1282-01, FA1282-11, FA1283-01, FA1283-11, 1281, 1281-11, 1281-12, 1281-50, FA1116-03, 1116, 1116-01, 1116-02, 1116-12, 1116-21, 1116-22, 1116-23, 1116-24, 1116-32, 1116-41, 1116-42, 1116-43, 1116-44, 1116-45, 1116-51, 1116-52, 1116-53, 1116-54, 1116-62, 1116-71, 1116-72, 1116-73, 1116-74, 1116-75, 1270, 1271
Operating environment	Operating system: Windows 10 Pro 64-bit; CPU: x64 processor running at 1.0 GHz or better (2.0 GHz or better recommended); memory: 2 GB or better (4 GB or better recommended); other software: Microsoft .NET Framework 4.6 and appropriate language pack
Supported languages	English, Japanese, Simplified Chinese, Traditional Chinese, Korean

#### Real-time anomaly monitoring

### Process Analyzer Client (E4781)



Adding Process Analyzer Pro's Singularity Detection Function to Inspection Equipment  
Detects latent defects in real time at the same time as normal inspection.

- Supported Products FA1811, FA1813, FA1816, FA1817

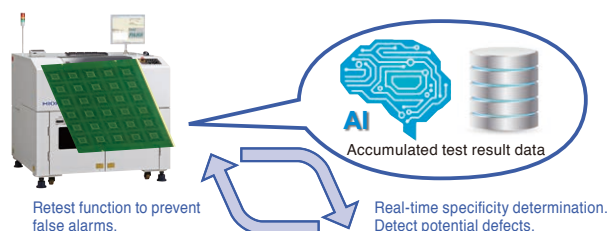

Step	Judg.	Stat. Judg.	Stor. Judg.	J	Mode	R	Reference	Measure	Upp.Lim.	Low.Lim.	S.D.	Point	H Point
1	PASS	PASS	PASS		R-CC	3	88.34 mΩ	84.97 mΩ	30.0 %	-30.0 %		1.357	418
2	PASS	PASS	PASS		R-CC	3	12.73 mΩ	13.38 mΩ	30.0 %	-30.0 %		1.804	2380
3	PASS	PASS	PASS		R-CC	3	427.4 mΩ	444.5 mΩ	30.0 %	-30.0 %		1.308	2378
4	SHL	SHL	PASS		R-CC	3	468.9 mΩ	593.9 mΩ	30.0 %	-30.0 %		5.709	2379
5	PASS	PASS	PASS		R-CC	3	142.0 mΩ	152.9 mΩ	30.0 %	-30.0 %		-1.784	423
6	PASS	PASS	PASS		R-CC	3	335.2 mΩ	330.2 mΩ	30.0 %	-30.0 %		0.353	424
7	SHL	SHL	PASS		R-CC	3	385.8 mΩ	367.8 mΩ	30.0 %	-30.0 %		5.709	291
8	PASS	PASS	PASS		R-CC	3	459.5 mΩ	500.0 mΩ	30.0 %	-30.0 %		0.347	2376
9	PASS	PASS	PASS		R-CC	3	139.7 mΩ	130.7 mΩ	30.0 %	-30.0 %		2.895	2375
10	PASS	PASS	PASS		R-CC	2	119.8 mΩ	110.4 mΩ	30.0 %	-30.0 %		-1.258	2974

## Robust Support for Repair Work Using Simple Operations and Assistive Functionality

### FAIL VISUALIZER UA1782

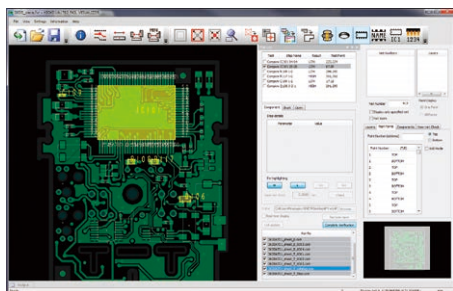

Robust support for repair work through simple operation and assistive functionality

Dedicated visualization software for Hioki electrical testing equipment and data creation systems

- Visualize test results from flying-probe testers
- Pinpoint components and patterns from test result files
- Display the probing positions of test fixtures or test heads for both ICT and bare board testers
- Search for components and nets on device embedded substrates

Model No. (Order Code) **UA1782** (supports UA1780 database input)  
**UA1782-01** (supports IPC-D-356 format input)  
**UA1782-02** (supports CAN & ADR format input)

#### Specifications Overview

License content	Install CD, license key (USB), instruction manual *Note: Please purchase hardware such as PC and monitor separately.
Database import	Load UA1780 and U-ART databases
Supported OS	Windows 10 Pro 64-bit
Net highlighting	Display user-specified nets with color highlighting. The user can select whether to display all layers or only top and bottom layers.
Fail list loading with real-time monitoring	Monitor a test result output folder for a testing system at a specified interval and automatically load new test data as it becomes available.

## Electrical Testing Verifies Correct Mounting ----- Populated Board Testing System

### FLYING PROBE TESTER FA1240-6x



Photo is the FA1240-61



- Quickly complete programs that take into account component height
- Automatic calculation of arm interference (when used with the UA1780)
- Designed to improve probe replaceability, dramatically reducing system downtime caused by probe replacement
- High-speed testing at up to 0.025 sec./step
- Proprietary Hioki lead float detection reliably detects issues up to and including pseudo-contact
- Provides a superior level of solder quality assurance
- Phase-isolated measurement and guarding functionality are ideal for analog circuits
- Support for active testing (optional feature)
- High-precision probing
- Large testing area of 510 × 460 mm (FA1240-61)
- Standard transport capability
- Automatic alignment function and simple visual test function

CE Compliant model: FA1241-61

Model No. (Order Code) **FA1240-61** (for large boards)  
**FA1240-63** (for medium rack boards)  
**FA1241-61** (CE compliant model, for large boards)

#### Specifications Overview

	FA1240-61 FA1241-61	FA1240-63
Number of arms	4 (L, ML, MR, R)	
Number of test steps	40,000 (max.)	
Measurement ranges	Resistance: 400 μΩ to 40 MΩ Capacitance: 1 pF to 400 mF Inductance: 1 μH to 100 H Diode VZ measurement: 0 to 25 V Zener diode VZ measurement: 0 to 25 V, 25 to 80 V (optional feature) Digital transistors: 0 to 25 V Photo couplers: 0 to 25 V Short: 0.4 Ω to 400 kΩ Open: 4 Ω to 40 MΩ DC voltage measurement: 0 to 25 V	
Measurement time	Max. 0.025 sec./step	Max. 0.025 sec./step
Probing precision	Within ±100 μm for each arm (X and Y directions)	
Positioning repeatability	Within ±50 μm (probing positions)	
Inter-probe pitch	Min. 0.15 mm Min. 0.5 mm (when using 4-terminal probes)	Min. 0.15 mm Min. 0.5 mm (when using 4-terminal probes)
Testable board dimensions	510 mm (20.08 in) W × 460 mm (18.11 in) D	400 mm (15.75 in) W × 330 mm (12.99 in) D
Power supply	200 V AC (single-phase), 50/60 Hz, 6 kVA (FA1241: 230 V AC)	200 V AC (single-phase), 50/60 Hz, 5 kVA
Dimensions and mass	1406 mm (55.35 in) H × 1300 mm (51.18 in) H × 1380 mm (54.33 in) D, 1150 kg (40,564.4 oz)	1266 mm (49.84 in) H × 1369 mm (53.90 in) H × 1425 mm (56.10 in) D, 1050 kg (37,037 oz)

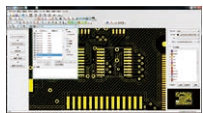

**FIT-LINE INSPECTION DATA CREATION SYSTEM**

**UA1780** (software with a four-year license term)  
**UA1780-01** (software with a one-year license term)  
**UA1780-11** (one year license renewal)  
**UA1780-14** (four year license renewal)

## Data Creation Software for Populated Board Testing

### FIT-LINE INSPECTION DATA CREATION SYSTEM UA1780

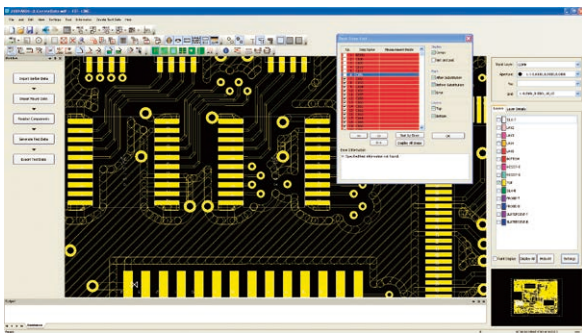

The UA1780 generates data from Gerber data and mounting data while referencing component library information

- No need for camera-based teaching
- No need to visually trace patterns under components
- Easy generation of high-quality test data without boards
- Support for the new FA1240 data format

Thanks to these features, programs can be created with plenty of time to spare before the prototyping stage. Anybody can generate high-quality test programs in a short period of time by using net information that has been reverse-generated from Gerber data and component information libraries. The UA1780 delivers maximum performance when used in conjunction with HIOKI's new FA1240-60 Flying probe tester.

Model No. (Order Code) **UA1780** (Software and 4 years license)  
**UA1780-01** (Software and 1 year license)  
**UA1780-11** (1 year license)  
**UA1780-14** (4 years license)

#### Specifications Overview

Included	Installation CD, license key (USB), instruction manual (× 1 each) *Caution: Computer, monitor, and other hardware not included.
Gerber data input functions	Loading of Gerber files (RS-274X, RS-274D), aperture files, and drill files
Mounting data input functions	Loading of CSV files containing circuit names, layout coordinates, angles of rotation, shape names, and component names Support for operations such as rotation and mirroring, and display of data such as mounting locations
Graphic editing functions	Copying, movement, deletion, and other manipulation of figures
Component library registration functions	Registration of component list displays and component size, height, and pin numbers; registration of test pin pairs, test modes, ratings (thresholds), and upper and lower limit values; duplication of libraries
Test data generation functions	Reverse net generation, test point extraction taking into account components and patterns, automatic movement of test points underneath components, generation of open tests between adjacent pads, etc.
Test point confirmation functions	Display of test points on a graphical screen
Test data output functions	FA1240 files, 1240/1114 files
Data management functions	Saving of databases and management of component libraries



## Batch Testing System for Improved Populated Circuit Board Productivity

### IN-CIRCUIT TESTER FA1220-02

**New**



CE

3 Year Warranty

- Slide-in mechanism simplifies installation and removal of test fixtures, reducing man-hours and workload.
- Extension range of options that reduces setup man-hours and boosts productivity.
- Numerous measurement parameters and detecting defects for a wide variety of inspections.
- Productivity, quality, and safety.
- Data creation support functionality: ATG function.

Model No. (Order Code) **FA1220-02**

• The FA1220-02 does not have a CD or DVD drive. You will need to provide an external CD or DVD drive in order to use the included application disc.

#### FA1220-02 Specifications Overview

Number of test points	Standard: 0 pins (scanner boards optional) Max. 2048 pins (expandable in blocks of 128 pins)* * The maximum number of active pins for each test type depends on the total number of scanner board pins installed in the product.
Number of test steps	Group data: 256 groups Round-robin short/open data: 2048 pins* Macro data: 2048 pins*/2048 steps (regardless of pin count) Component data: 10000 steps Charge data: 40 groups Pin contact data: 2048 pins* IC data: 500 steps (max. 2048 pins/step)* * The maximum number of active pins for each test type depends on the total number of scanner board pins installed in the product.
Measurement unit	DC voltmeter: 800 $\mu$ V f.s. to 25 V f.s., 8 ranges DC ammeter: 100 nA f.s. to 250 mA f.s., 9 ranges AC ammeter: 10 $\mu$ A rms to 10 mA rms, 4 ranges HV voltmeter: 25 mV f.s. to 250 V f.s. (Requires E4210 and E4203) HV ammeter: 1.2 $\mu$ A f.s. to 120 mA f.s. (Requires E4210 and E4203)
Scanner unit	Switch type: analog (Scanner Board E4201 and E4202), read relay (Scanner Board E4203) Number of channels: 128 per board Input protection: $\pm$ 15 V (Scanner Board E4201 and E4202), none (Scanner Board E4203)
External I/O	Ethernet (LAN) 100Base-TX $\times$ 1 (please contact Hioki for communication with external devices.)
Control unit	- Measurement control Operating system: Real-time operating system Storage device: SD card (for booting system)  - Main unit control Operating system: Windows 10 Pro (64-bit) Storage device: 64 GB SSD Operation: keyboard and mouse Display: 15-inch display Printer: E4243 (option)
Power supply	Rated supply voltage: 100 to 240 V AC, 50 Hz/60 Hz Maximum power consumption: 1 kVA
Dimensions and mass	655 mm (25.79 in.) W $\times$ 1830 mm (72.05 in.) H $\times$ 705 mm (27.76 in.) D, 310 kg (10934.7 oz.)
Included accessories	Instruction Manual $\times$ 1, Test lead $\times$ 1, Application disc $\times$ 1, Positioning screws $\times$ 4, Maintenance key (for opening and closing the maintenance door) $\times$ 1

## Boost Productivity of Populated Circuit Board Testing with the Inline Automatic Testing System

### IN-CIRCUIT TESTER FA1220-11

**New**



CE

3 Year Warranty

- Installation area about 23% smaller than the previous model. Offers new flexibility for production line layout by saving space.
- Extension range of options that reduces setup man-hours and boosts productivity.
- Numerous measurement parameters and detecting defects for a wide variety of inspections
- Safeguard people, products, and lines with many safety features.
- Data creation support functionality: ATG function.

Model No. (Order Code) **FA1220-11**

• The FA1220-11 does not have a CD or DVD drive. You will need to provide an external CD or DVD drive in order to use the included application disc.

#### FA1220-11 Specifications Overview

Number of test points	Standard: 0 pins (scanner boards optional) Max. 2048 pins (expandable in blocks of 129 pins)* * The maximum number of active pins for each test type depends on the total number of scanner board pins installed in the product.
Number of test steps	Group data: 256 groups Round-robin short/open data: 2048 pins* Macro data: 2048 pins/2048 steps (regardless of pin count)* Component data: 10000 steps Charge data: 40 groups Pin contact data: 2048 pins* IC data: 500 steps (max. 2048 pins/step)* * The maximum number of active pins for each test type depends on the total number of scanner board pins installed in the product.
Measurement unit	DC voltmeter: 800 $\mu$ V f.s. to 25 V f.s., 8 ranges DC ammeter: 100 nA f.s. to 250 mA f.s., 9 ranges AC ammeter: 10 $\mu$ A rms to 10 mA rms, 4 ranges
Scanner unit	Switch type: analog (E4201 and E4202), read relay (E4203) Number of channels: 128 per board Input protection: $\pm$ 15 V / $\pm$ 0.5 V (batch-configurable, E4201 and E4202), none (E4203)
External I/O	Ethernet (LAN) 100Base-TX $\times$ 1 (please contact Hioki for communication with external devices.) USB 2.0 $\times$ 1
Control unit	- Measurement control Operating system: Real-time operating system Storage device: SD card (for booting system)  - Main unit control Operating system: Windows 10 Pro (64-bit) Storage device: 64 GB SSD Operation: keyboard and mouse Display: 15-inch display Printer: E4243 (option)
Power supply	Rated supply voltage: 100 to 240 V AC, 50 Hz/60 Hz Maximum power consumption: 1 kW Maximum current consumption: 10 A
Dimensions and mass	780 mm (30.71 in.) W $\times$ 1760 mm (69.29 in.) H $\times$ 750 mm (29.53 in.) D, 390 kg (13756.6 oz.)
Included accessories	Instruction Manual $\times$ 1, Test lead $\times$ 1, Application disc $\times$ 1, Positioning screws $\times$ 4, Maintenance key (for opening and closing the maintenance door) $\times$ 1, Set of transport motor accessories $\times$ 1, Before and after process communication connector set $\times$ 2

## Embed Electronic Circuit Board Component, Mounting Status, and Function Testing into Existing Equipment

### IN-CIRCUIT TESTER FA1220



- Functionality has been consolidated in a single, desktop tower that can be easily embedded in existing equipment
- Extensive function testing
- Electrolytic capacitor and IC reverse insertion detection
- Macro-testing function to increase test efficiency
- Four-terminal low-resistance measurement for stable measurement of low resistance
- High-voltage Zener diode measurement capability up to 100 V (requires options E4204 and E4210)
- Insulation measurement function (requires option E4210)

Model No. (Order Code) **FA1220** (Main unit only)

- Data from the legacy 1101 and 1102 cannot be converted for use by the 1220 (FA1220) because Hioki is unable to supply computers that can run the 1137 Support Software.
- Data compatibility between the FA1220/FA1221 and legacy products (1220-00/-01/-02/-11/-50/-51/-52/-55): Although data created for legacy products can be used, such data is not fully compatible with the FA1220/FA1221. It may be necessary to perform stray capacitance acquisition, wiring resistance acquisition, S/O data acquisition, IC data acquisition, and component test debugging. In particular, it may be necessary to reacquire stray capacitance in applications that involve measurement of minuscule capacitance values.

#### FA1220 Specifications Overview

Number of test points	Max. 1024 pins (Can be added in blocks of 128 pins.) Standard : 0 pins (Scanner boards are sold as options.)
Number of test steps	Round-robin short/open data : 1024 pins Component data : Max. 10000 steps Macro data : 1024 pins/1024 steps (regardless of number of pins) IC data : 500 steps (max. 1024 pins/step) Charge data : 40 sets Pin contact data : 1024 pins Group data : 255 groups
Test parameters and measurement ranges	Round-robin short/open : 4 Ω to 400 kΩ (Default: 40 Ω) Macro testing (impedance) : 1 Ω to 10 MΩ Component tests : Possible IC reverse insertion detection : Possible
Measurement unit	DC voltmeter : 800 μV f.s. to 25 V f.s., 8 ranges DC ammeter : 100 nA f.s. to 250 mA f.s., 9 ranges AC ammeter : 10 μArms f.s. to 10 mA rms f.s., 4 ranges Macro test : Ammeter 10 μ / 100 μ / 1 m / 10 m Arms, 4 ranges
Scanner unit*2	Software used : Analog switch (Scanner board E4201, E4202) Number of channels : 128 channels/board (2-/4-terminal switchable) Input protection : ±15 V / ±0.5 V (Batch-configurable, Scanner Board E4201 / E4202 only)
External I/O *2	Using I/O Board E4220*1 : 60 inputs, 56 outputs *1 Hioki plans to update the FA1220/FA1221 to provide functionality for configuring the I/O Board E4220. *2 Sold separately.
Control unit	External computer (sold separately) FA1220: Real-time operating system, LAN for PC connectivity (10 / 100 ×1 port)
Power supply	100 to 240 V AC (±10%), single-phase, 50 Hz / 60 Hz, max. 260 W (with full 1024 pins of scanner boards)
Dimensions and mass	200 mm (7.87 in) W × 323 mm (12.72 in) H × 298 mm (11.73 in) D, 10 kg (352.7 oz)
Included accessories	Instruction manual ×1, Test leads ×1, Power cord ×1, Metal fittings ×1, Installation CD ×1

Factory-installed options



**SCANNER BOARD E4201**  
Semiconductor scanner board with guarding; 128 channels per board \*Cannot be combined with other scanner/relay boards.



**SCANNER BOARD E4202**  
Semiconductor scanner board without guarding; 128 channels per board \*Cannot be combined with other scanner/relay boards.

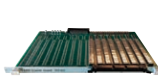

**SCANNER BOARD E4204**  
Reed relay scanner board, with guarding; 64 channels per board \*Cannot be combined with other scanner/relay boards.



**I/O BOARD E4220**  
Configurable pin numbers.

**INTERNAL POWER SUPPLY E4230**  
Internal 24 V power supply for external control use; adds outlet to rear of main unit; requires I/O Board E4220



**1220 DATA COMPOSITION SOFTWARE 1137-05**  
Create data on a general-purpose computer



**SHIELDED SCANNER CABLE E4232**  
64 pins, single-sided angled type, 2 m (6.56 ft) length



**CONTROL CABLE E4240**  
E4220-compatible I/O connector, 64-channel MIL connector, 2 m (6.56 ft) length



**RECORDING PAPER 1197**  
58 mm (2.28 in) × 30 m (98.43 ft), 10 rolls/set

Options



**LAN CONNECT UNIT 1913-03**  
For connecting computer to an external network



**CALIBRATION UNIT FOR MEASUREMENT SECTION 1330**

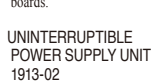

**UNINTERRUPTIBLE POWER SUPPLY UNIT 1913-02**  
For computer and LCD

**I2C TEST UNIT 1960-10**

**INSULATION MEASUREMENT FUNCTION E4210**  
High voltage Zener diode, high voltage measurement, insulation measurement (requires E4204)

**ONBOARD PROGRAMMING FUNCTION E4231**

**PERSONAL COMPUTER UNIT 1913-01**  
Computer, LCD, miniprinter, LAN cable, 1220 computer application (FA1221 control computer is an option.)

## Multichannel Short/Open Tester that can be Embedded in Your Test Equipment

### SHORT-OPEN TESTER FA1221



- Functionality has been consolidated in a single, desktop tower that can be easily embedded in existing equipment
- Specifically designed for short/open testing
- Four-terminal low-resistance measurement for stable measurement of low resistance

Model No. (Order Code) **FA1221** (Main unit only)

#### FA1221 Specifications Overview

Number of test points	128 pins (during 4-terminal measurement, up to 32 sets)
Number of test steps	Round-robin short/open : 128 pins Component data : Max. 10000 steps Charge data : 40 sets Pin contact data : 128 pins Group data : 255 groups
Test parameters and measurement ranges	Round-robin short/open : 4 Ω to 400 kΩ (Default: 40 Ω) Component tests : Possible
Component tests	Resistance : 400 μΩ to 40 MΩ Open : 4 Ω to 4 MΩ Short : 400 mΩ to 40 Ω
Test signals	DC constant voltage : 100 m / 400 mV : 2 ranges DC constant current : 2 m / 20 mA, 2 ranges
Measurement unit	DC ammeter : Ammeter 80 μ / 800 μ / 4 m / 40 m Arms, 4 ranges DC ammeter : 250 n / 2.5 μ / 25 μ / 250 μ / 2.5 m / 25 mA f.s., 6 ranges
Scanner unit	Analog software : 128 channels/board (2-/4-terminal switchable, no guarding)
Judgment range	-99.9% to +999.9% or absolute value
Measurement times	Round-robin short/open : From approx. 0.8 ms per pin Component : From approx. 0.9 ms per step
Statistics functionality	Defect rate tabulation and graph display test, group, and overall; component test histogram; operating time cumulative and subtotal displays
External I/O *2	Using I/O Board E4220*1 : 60 inputs, 56 outputs *1 Hioki plans to update the FA1220/FA1221 to provide functionality for configuring the I/O Board E4220. *2 Sold separately.
Power supply	100 to 240 V AC (±10%), single-phase, 50 Hz / 60 Hz, max. 130 W
Dimensions and mass	200 mm (7.87 in) W × 323 mm (12.72 in) H × 298 mm (11.73 in) D, 10 kg (352.7 oz)
Included accessories	Instruction manual ×1, Test leads ×1, Power cord ×1, Metal fittings ×1, Installation CD ×1

Options



**1220 DATA COMPOSITION SOFTWARE 1137-05**  
Create data on a general-purpose computer



**SHIELDED SCANNER CABLE E4232**  
64 pins, single-sided angled type, 2 m (6.56 ft) length



**CONTROL CABLE E4240**  
E4220-compatible I/O connector, 64-channel MIL connector, 2 m (6.56 ft) length



**RECORDING PAPER 1197**  
58 mm (2.28 in) × 30 m (98.43 ft), 10 rolls/set

Factory-installed options



**I/O BOARD E4220**  
Configurable pin numbers.

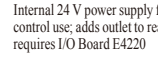

**INTERNAL POWER SUPPLY E4230**  
Internal 24 V power supply for external control use; adds outlet to rear of main unit; requires I/O Board E4220

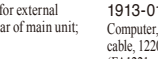

**PERSONAL COMPUTER UNIT 1913-01**  
Computer, LCD, miniprinter, LAN cable, 1220 computer application (FA1221 control computer is an option.)



**LAN CONNECT UNIT 1913-03**  
For connecting computer to an external network

**UNINTERRUPTIBLE POWER SUPPLY UNIT 1913-02**  
For computer and LCD

## **Model No. (Order Code) Index**

# Model No. (Order Code) Index

Note: D mark : Discontinued or discontinuation scheduled models.

Model No.	Name	Page	Note	Model No.	Name	Page	Note
D OGA00016	MEASURING LEAD (BLACK)	58	For SM7810, DSM-LBC50	D 9268	DC BIAS VOLTAGE UNIT	45	For the 3511-50 and similar products
OGA00019	MEASURING LEAD (RED)	58	For SM7810, DSM-LR010	9268-10	DC BIAS VOLTAGE UNIT	42	For the IM3590/3570/3533/3523 and similar products
OGA00021	MEASURING LEAD (RED)	58	For SM7810, DSM-LR020	D 9269	DC BIAS CURRENT UNIT	45	For the 3511-50 and similar products
OGA00027	MEASURING LEAD (RED)	58	For SM7810, DSM-LR050	9269-10	DC BIAS CURRENT UNIT	42	For the IM3590/3570/3533/3523 and similar products
1196	RECORDING PAPER	--	For the 9442 (ST5540), 112mm width	9272-05	CLAMP ON SENSOR	85	20/200 A AC, ME15W terminal
2103H	METER RELAY	116	H type, upper-limit setting	9290-10	CLAMP ON ADAPTER	89	
2103HL	METER RELAY	116	HL type, upper/lower-limit setting	9292	TEST PROBE	--	For the 3451, 3452
2103L	METER RELAY	116	L type, lower-limit setting	9296	CURRENT PROBE	68	For the 3157-01
2104H	METER RELAY	116	H type, upper-limit setting	9297	CURRENT APPLY PROBE	68	For the 3157-01
2104HL	METER RELAY	116	HL type, upper/lower-limit setting	9299	SWITCHED PROBE	66	For the ST5520 and similar products
2104L	METER RELAY	116	L type, lower-limit setting	9318	CONVERSION CABLE	85	To connect HOKI PL23 (10 pin) connector to the 8971/40/51
3030-10	HITESTER	101		9320-01	LOGIC PROBE	26	For the Memory HiCorder, miniature terminal type
3153	AUTOMATIC INSULATION WITHSTANDING HITESTER	67	Insulation, AC/DC Withstanding Voltage	9322	DIFFERENTIAL PROBE	25	For the Memory HiCorder series
3157-01	AC GROUNDING HITESTER	68	100-120 / 200-240 VAC switching	9327	LOGIC PROBE	26	For the MR8847 series, 8860 series, 8855
3174	AC AUTOMATIC INSULATION WITHSTANDING HITESTER	67		D 9328	POWER CORD	25	For the 9322
3244-60	CARD HITESTER	101		9333	LAN COMMUNICATOR	28	For the MR8741s, MR8847-01s, 8826
3246-60	PENCIL HITESTER	101		9335	WAVE PROCESSOR	28	For the Memory HiCorder series
3269	POWER SUPPLY	81	For the CT6710s/CT6700s/3270s	9355	CARRYING CASE	85	For the 9272-10, 9270s, and similar products
3272	POWER SUPPLY	81	For the CT6700s/3270s, up to 1	9380	CARRYING CASE	62	For the SS7012, 7011
3273-50	CLAMP ON PROBE	81	DC to 50 MHz, 30 Arms	9390	CARRYING CASE	101	For the 3030-10
3274	CLAMP ON PROBE	81	DC to 10 MHz, 150 Arms	9398	CARRYING CASE	108	For the 3287/88, 3280-10/-20
3275	CLAMP ON PROBE	81	DC to 2 MHz, 500 Arms	9418-15	AC ADAPTER	26	For the 9322, 3197 and similar products
3276	CLAMP ON PROBE	81	DC to 100 MHz, 30 Arms	9444	CONNECTION CABLE	--	For the Printer 9442
3280-10F	AC CLAMP METER	109	Average rectified	9445-02	AC ADAPTER	87	For the CM7290 and similar products, 100 to 240 V AC
3280-70F	AC CLAMP METER SET	109	3280-10F, CT6280 bundled model	9446	CONNECTION CABLE	--	For the Printer 9442
3287	CLAMP ON AC/DC HITESTER	108	True RMS	9447	BATTERY PACK	--	For the 8807/08, 8420 series
3288	CLAMP ON AC/DC HITESTER	107	Average rectified	9451	TEMPERATURE PROBE	57	For the BT3554-50 series
3288-20	CLAMP ON AC/DC HITESTER	107	True RMS	9451-01	TEMPERATURE PROBE	57	For the BT3554-50 series
3333	POWER HITESTER	75		9452	CLIP TYPE LEAD	--	For the 3239, 3555, 3541, 3540 and similar products
3333-01	POWER HITESTER	75	Built-in GP-IB	9453	FOUR TERMINAL LEAD	48	For the RM3548, 3561/60, 3541/40 and similar products
3334	AC/DC POWER HITESTER	75		9454	ZERO ADJUSTMENT BOARD	48	For the RM3548(9465-10), BT3563(L2100) and similar products
3334-01	AC/DC POWER HITESTER	75	Built-in GP-IB	9455	PIN TYPE LEAD	--	For the 3239, 3541 and similar products
3481-20	VOLTAGE DETECTOR	114		9459	BATTERY PACK	78	For the PW3360s, 3351, 3197, 3455
3490	ANALOG I/O HITESTER	105	Bundled with standard Test Lead L9787	9460	CLIP TYPE LEAD WITH TEMPERATURE SENSOR	57	For the BT3554-50 and similar products
3504-40	C HITESTER	46	Built-in RS-232C interface	9461	PIN TYPE LEAD	--	For the 3239, 3555, 3541 and similar products
3504-50	C HITESTER	46	Built-in GP-IB, RS-232C	9465-10	PIN TYPE LEAD	48	For the RM3548, 3554 and similar products
3504-60	C HITESTER	46	Built-in GP-IB, RS-232C	9465-90	TIP PIN	48	For the RM3548 and similar products (9465-10, L2020)
3506-10	C METER	46	Measurement frequencies: 1 kHz and 1 MHz	9466	REMOTE CONTROL SWITCH	57	For the BT3554-50 (use with the L2020), 9772, 9465-10
D 3511-50	LCR HITESTER	45	Measurement frequencies: 120 Hz and 1 kHz	9467	LARGE CLIP TYPE LEAD	48	For the RM3548, 3561, 3541/40 and similar products
3561	BATTERY HITESTER	56		D 9472	SHEATH TYPE TEMPERATURE PROBE	96	For the 3441, 3442 and similar products
3561-01	BATTERY HITESTER	56	Built-in GP-IB interface	9472-50	SHEATH TYPE TEMPERATURE PROBE	96	For the 3446-01 only
D 3664	OPTICAL POWER METER	91		D 9473	SHEATH TYPE TEMPERATURE PROBE	96	For the 3441, 3442 and similar products
3665-20	LAN CABLE HITESTER	92	English model	D 9474	SHEATH TYPE TEMPERATURE PROBE	96	For the 3441, 3442 and similar products
3930	HIGH VOLTAGE SCANNER	65	For the 3153 and similar products	D 9475	SHEATH TYPE TEMPERATURE PROBE	96	For the 3441, 3442 and similar products
8423	MEMORY HILOGGER	35	Main unit only	D 9476-50	SURFACE TYPE TEMPERATURE PROBE	96	For the 3446-01 only
8948	VOLTAGE/TEMP UNIT	35	For the 8423	9478	SHEATH TYPE TEMPERATURE PROBE	96	For the IM3590/IM3533/3447, P1100
8949	UNIVERSAL UNIT	35	For the 8423	9500	4-TERMINAL PROBE	49	For the RM3543, 3532-80
8966	ANALOG UNIT	19	For MR6000, MR8847A, MR8827, and similar products	9500-10	4-TERMINAL PROBE	42	For the IM3590/3570/3533/3523 and similar products
8967	TEMP UNIT	19	For MR6000, MR8847A, MR8827, and similar products	D 9518-01	GP-IB INTERFACE	45	For the 3511-50 and similar products
8968	HIGH RESOLUTION UNIT	19	For MR6000, MR8847A, MR8827, and similar products	9518-02	GP-IB INTERFACE	68	For the 3157-01
8970	FREQ UNIT	19	For MR6000, MR8847A, MR8827, and similar products	9593-03	RS-232C INTERFACE	68	For the 3157-01
8971	CURRENT UNIT	19	For MR6000, MR8847A, MR8827, and similar products	9613	REMOTE CONTROL BOX(SINGLE)	67	For the 3174, 3153/57/58/59 series
8972	DC/RMS UNIT	19	For MR6000, MR8847A, MR8827, and similar products	9614	REMOTE CONTROL BOX(DUAL)	67	For the 3174, 3153/57/58/59 series
8973	LOGIC UNIT	19	For MR6000, MR8847A, MR8827, and similar products	9615	H.V. TEST LEAD	67	For the 3174/73/59/58/53
8996	DIGITAL/PULSE UNIT	35	For the 8423	9615-01	H.V. TEST LEAD	65	For the 3930
8997	ALARM UNIT	35	For the 8423	9631-01	TEMPERATURE SENSOR	105	For the IR3455, 3630 series
9010-50	CLAMP ON PROBE	88	BNC output terminal	9631-02	TEMPERATURE SENSOR	--	For the 3630 series
9017	HIGH VOLTAGE PROBE	101	For the 3030-10	9631-03	TEMPERATURE SENSOR	--	For the 3630 series
9018-50	CLAMP ON PROBE	88	Wide band, BNC output terminal	9631-05	TEMPERATURE SENSOR	105	For the IR3455, 3630 series
9032	METAL CONTACT TIP	--	For the FT3405/06, 3403/04	9631-11	TEMPERATURE SENSOR(9631-01,5m)	--	For the 3630 series
9033	RUBBER CONTACT TIP	--	For the FT3405/06, 3403/04	9631-14	TEMPERATURE SENSOR(9631-04,5m)	--	For the 3630 series
9050	EARTH NETS	113	For the FT6031, FT3151	9631-21	TEMPERATURE SENSOR(9631-01,10m)	--	For the 3630 series
9132-50	CLAMP ON PROBE	88	BNC output terminal	9632	CONNECTION CABLE	--	For the 3630 series
9140	4-TERMINAL PROBE	47	For the 3511/22/31/32 and similar products models	9637	RS-232C CABLE(9pin-9pin/1.8m)	55	For the BT3563, and similar products
9140-10	4-TERMINAL PROBE	47	For the IM3590/3570/3533/3523 and similar products	9641	CONNECTION CABLE	35	For the LR8431-20, 8430-20 and similar products
9151-02	GP-IB CONNECTOR CABLE	74	For the PW3335 and similar products	9642	LAN CABLE	26	For the Memory HiCorder, LR8450, and similar products
9165	CONNECTION CORD	26	For the Memory HiCorder, 9268(3511-50), and similar products	9657-10	CLAMP ON LEAK SENSOR	89	For the PW3360/65, PW3198/3197, LR8513 and similar products
9166	CONNECTION CORD	26	For the Memory HiCorder, 9268(3511-50), and similar products	9660	CLAMP ON SENSOR	89	For the PW3360/65, 3169, PW3198 and similar products
9168	INPUT CORD	62	For the SS7012, 7011/10	9661	CLAMP ON SENSOR	89	For the PW3360/65, 3169, PW3198 and similar products
D 9180	SHEATH TYPE TEMPERATURE PROBE	96	For the 3441/42 and similar products	9665	10:1 PROBE	26	For the Memory HiCorder series
9181	SURFACE TEMPERATURE PROBE	96	For the 3441/42 and similar products	9666	100:1 PROBE	26	For the Memory HiCorder series
D 9183	SHEATH TYPE TEMPERATURE PROBE	96	For the 3441/42 and similar products	9669	CLAMP ON SENSOR	89	For the PW3360/65, PW3198/3197, LR8513 and similar products
9184	TEMPERATURE PROBE	62	For the SS7012, 7011	9675	CLAMP ON LEAK SENSOR	89	For the PW3360/65, PW3198/3197, LR8513 and similar products
9195	ENCLOSURE PROBE	64	For the ST5540 series, 3156/3155	9677	SMD TEST FIXTURE	47	For the IM3570 and similar products
9199	CONVERSION ADAPTOR	26	For Memory HiCorder, the 3283 and similar products	9680-50	HUMIDITY SENSOR	--	For the 3641
9209	TEST LEADS HOLDER	109	For the 3280-10F and similar products	9680-51	HUMIDITY SENSOR	--	For the 3641
9211	REFLECTIVE TAPE	--	For the FT3405/06, 3403/04, 10 sheets set	9683	CONNECTION CABLE	35	For the 8423, PW3390
9212	PERIPHERAL RING	--	For the FT3405/06, 3403/04	9690-01	TERMINATOR(ID1-5)	92	For the 3665-20
9215	MEASURING CABLE	--	For the 3151	9690-02	TERMINATOR(ID6-10)	92	For the 3665-20
9219	CONNECTION CABLE	89	For the 9695-02/-03	9690-03	TERMINATOR(ID11-15)	92	For the 3665-20
9221	RECORDING PAPER	26	For the 8835-01, 8815/30/35, 8852, 10 rolls	9690-04	TERMINATOR(ID16-20)	92	For the 3665-20
9229	RECORDING PAPER	26	For the 8826, 8825, 6 rolls/set	9694	CLAMP ON SENSOR	89	For the PW3360/65, 3169, PW3198 and similar products
9229-01	RECORDING PAPER(PERFORATED)	26	For the 8826, 8825, (Perforated) 6 rolls/set	9695-02	CLAMP ON SENSOR	89	For the PW3360/65, 3169, PW3198 and similar products
9231	RECORDING PAPER	26	For the MR8847s, 8860-50/8861-50, 8855/4615/42/41/40, 6 rolls/set	9695-03	CLAMP ON SENSOR	89	For the PW3360/65, 3169, PW3198 and similar products
9232	RECORDING PAPER	26	For the 3193-10, 8804 and similar products, 10 rolls	9699	SMD TEST FIXTURE	47	For the IM3533, and similar products
9233	RECORDING PAPER	--	For the 9203, 3155, 10 rolls/set	9701	HUMIDITY SENSOR	--	For the 8949 (8423)
9234	RECORDING PAPER	26	For the MR8880-20, 8807/08, 8420 series, 10 rolls/set	9704	CONVERSION ADAPTER	88	For the OT9667 series, 9132-50 and similar products
9235	RECORDING PAPER	26	For the 8205-10, 8206-10, 60mm width	9713-01	CAN CABLE	20	For the MR8904(MR8875), U8555/LR8535(LR8450)
9236-01	RECORDING PAPER	26	For the 8205-10, 8206-10, 60mm width (Climate-resistant)	D 9721	RS-232C CABLE	65	For the Printer 9442
D 9246	CARRYING CASE	91	For the 3664	9723	CARRYING CASE	--	For the 8860
9248	POWER CORD	25	For the 9322 to 9687 connect	9728	PC CARD 512M	26	512 MB
9249	CARRYING CASE	92	For the 3665-20	9729	PC CARD 1G	26	1 GB
9261	TEST FIXTURE	47	For the 3511-50 and similar products	D 9742	OPTICAL SENSOR	91	For the 3664 only
9261-10	TEST FIXTURE	47	For the IM3590/3570/3533/3523 and similar products	D 9742-10	OPTICAL SENSOR	91	For the 3664 only
9262	TEST FIXTURE	47	For the 3511-50 and similar products	D 9743	OPTICAL SENSOR	91	For the 3664 only
9263	TEST FIXTURE	47	For the 3511-50 and similar products	D 9743-10	OPTICAL SENSOR	91	For the 3664 only
9267	SAFETY TEST DATA MANAGEMENT SOFTWARE	65	For ST5540/ST5541, 3153 and similar products	9750-01	TEST LEAD	105	For the IR3455, 3455

# Model No. (Order Code) Index

Note: D mark : Discontinued or discontinuation scheduled models.

Model No.	Name	Page	Note	Model No.	Name	Page	Note
9750-02	TEST LEAD	105	For the IR3455, 3455	CT6280	AC FLEXIBLE CURRENT SENSOR	110	For the CM3291/89, 3280-10F and similar products
9750-03	TEST LEAD	105	For the IR3455, 3455	CT6500	CLAMP ON SENSOR	30	For the LR8513, LR5051
9750-11	TEST LEAD	105	For the IR3455, 3455	CT6700	CURRENT PROBE	80	From 1mA, 50MHz bandwidth
9750-12	TEST LEAD	105	For the IR3455, 3455	CT6701	CURRENT PROBE	80	From 1mA, 120MHz bandwidth
9750-13	TEST LEAD	105	For the IR3455, 3455	CT6710	CURRENT PROBE	80	From 200µA, 50MHz bandwidth
9751-01	ALLIGATOR CLIP	105	For the IR3455, 3455	CT6711	CURRENT PROBE	80	From 200µA, 120MHz bandwidth
9751-02	ALLIGATOR CLIP	105	For the IR3455, 3455	CT6841A	AC/DC CURRENT PROBE	85	20 A AC/DC, ME15W terminal
9751-03	ALLIGATOR CLIP	105	For the IR3455, 3455	CT6843A	AC/DC CURRENT PROBE	85	200 A AC/DC, ME15W terminal
9757	CARRYING CASE	95	For the FT3432	CT6844A	AC/DC CURRENT PROBE	84	500 A AC/DC, ME15W terminal
9758	EXTENSION CABLE	94	For the FT3470-52/51	CT6845A	AC/DC CURRENT PROBE	84	500 A AC/DC, ME15W terminal
9759	OUTPUT CABLE	94	For the FT3470-52/51	CT6846A	AC/DC CURRENT PROBE	84	1000 A AC/DC, ME15W terminal
9770	PIN TYPE LEAD	54	For the BT3563, BT3562, 3561/55/41 and similar products	CT6862-05	AC/DC CURRENT SENSOR	83	50 A AC/DC, ME15W terminal
9770-90	TIP PIN	54	For the 9770, L2102, replacement tip	CT6863-05	AC/DC CURRENT SENSOR	83	200 A AC/DC, ME15W terminal
9771	PIN TYPE LEAD	54	For the BT3563, BT3562, 3561/55/41 and similar products	CT6872	AC/DC CURRENT SENSOR	83	50 A AC/DC, ME15W terminal, 3 m (9.84 ft) cable length
9771-90	TIP PIN	54	For the 9771, L2103, replacement tip	CT6872-01	AC/DC CURRENT SENSOR	83	50 A AC/DC, ME15W terminal, 10 m (32.81 ft) cable length
9772	PIN TYPE LEAD	48	For the RM3548, 3554 and similar products	CT6873	AC/DC CURRENT SENSOR	83	200 A AC/DC, ME15W terminal, 3 m (9.84 ft) cable length
9772-90	TIP PIN	48	For the 9772(RM3548/3554), L2100(BT3563/62)	CT6873-01	AC/DC CURRENT SENSOR	83	200 A AC/DC, ME15W terminal, 10 m (32.81 ft) cable length
9780	BATTERY PACK	20	For the MR8870-20, LR8431-20, 8430-20 series	CT6875A	AC/DC CURRENT SENSOR	82	500 A AC/DC, ME15W terminal, 3 m (9.84 ft) cable length
9782	CARRYING CASE	20	For the MR8870-20, LR8431-20, 8430-20, SS7012	CT6875A-1	AC/DC CURRENT SENSOR	82	500 A AC/DC, ME15W terminal, 10 m (32.81 ft) cable length
9783	CARRYING CASE	21	For the MR8847 series	CT6876A	AC/DC CURRENT SENSOR	82	1000 A AC/DC, ME15W terminal, 3 m (9.84 ft) cable length
9784	DC POWER UNIT	21	For the MR8847 series	CT6876A-1	AC/DC CURRENT SENSOR	82	1000 A AC/DC, ME15W terminal, 3 m (9.84 ft) cable length
9790-02	GRABBER CLIP	26	For the L9790	CT6877A	AC/DC CURRENT SENSOR	82	2000 A AC/DC, ME15W terminal, 3 m (9.84 ft) cable length
9790-03	CONTACT PIN	26	For the L9790	CT6877A-1	AC/DC CURRENT SENSOR	82	2000 A AC/DC, ME15W terminal, 10 m (32.81 ft) cable length
9794	CARRYING CASE	72	For the PW3390, 3390	CT6904A	AC/DC CURRENT SENSOR	82	500 A AC/DC Rated, ME15W terminal, 3 m (9.84 ft) cable length
9804	MAGNETIC ADAPTER	97	For the DT4242/53/54/55/56, and similar products	CT6904A-1	AC/DC CURRENT SENSOR	82	Special order products up to 500 A, ME15W terminal, 10 m (32.81 ft) cable length
9804-01	MAGNETIC ADAPTER	78	For the L9438s(PW3360s and similar products), red x1	CT6904A-2	AC/DC CURRENT SENSOR	82	Special order products up to 800 A, ME15W terminal, 3 m (9.84 ft) cable length
9804-02	MAGNETIC ADAPTER	78	For the L9438s(PW3360s and similar products), black x1	CT6904A-3	AC/DC CURRENT SENSOR	82	Special order products up to 800 A, ME15W terminal, 10 m (32.81 ft) cable length
9809	PROTECTION SHEET	20	For the MR8870-20/8870-20, LR8431-20, 8430-20	CT7044	AC FLEXIBLE CURRENT SENSOR	87	6000 A, φ100 mm (3.94 in)
9812	SOFT CASE	20	For the MR8870-20/8870, LR8431-20, 8430-20	CT7045	AC FLEXIBLE CURRENT SENSOR	87	6000 A, φ180 mm (7.09 in)
9830	PC CARD 2G	26	2 GB	CT7046	AC FLEXIBLE CURRENT SENSOR	87	6000 A, φ254 mm (10.00 in)
BT3554-50	BATTERY TESTER	57	Pin Type Lead not included	CT7116	AC LEAKAGE CURRENT SENSOR	89	For the PQ3100, 6 A, PL14 terminal
BT3554-51	BATTERY TESTER	57	Bundled with Pin Type Lead 9465-10	CT7126	AC CURRENT SENSOR	89	For the PQ3100, 60 A, PL14 terminal
BT3554-52	BATTERY TESTER	57	Bundled with Pin Type Lead L2020	CT7131	AC CURRENT SENSOR	89	For the PQ3100, 100 A, PL14 terminal
BT3554-91	BATTERY TESTER	57	BT3554-51 + Wireless Adapter Z3210	CT7136	AC CURRENT SENSOR	89	For the PQ3100, 600 A, PL14 terminal
BT3554-92	BATTERY TESTER	57	BT3554-52 + Wireless Adapter Z3210 (Recommended)	CT7631	AC/DC CURRENT SENSOR	86	100 A AC/DC, φ33 mm (1.30 in)
BT3561A	BATTERY HITESTER	53	Compact packs up to 60 V	CT7636	AC/DC CURRENT SENSOR	86	600 A AC/DC, φ33 mm (1.30 in)
BT3562A	BATTERY HITESTER	53	Medium-size packs up to 100 V	CT7642	AC/DC CURRENT SENSOR	86	2000 A AC/DC, φ55 mm (2.17 in)
BT3562-01	BATTERY HITESTER	55	Built in GP-IB and analog output	CT7731	AC/DC AUTO-ZERO CURRENT SENSOR	86	100 A AC/DC, φ33 mm (1.30 in)
BT3563A	BATTERY HITESTER	54	Large packs up to 300 V	CT7736	AC/DC AUTO-ZERO CURRENT SENSOR	86	600 A AC/DC, φ33 mm (1.30 in)
BT3563-01	BATTERY HITESTER	55	Built in GP-IB and analog output	CT7742	AC/DC AUTO-ZERO CURRENT SENSOR	86	2000 A AC/DC, φ55 mm (2.17 in)
BT3564	BATTERY HITESTER	54		CT9555	SENSOR UNIT	84	For the CT6841A, etc., ME15W connector
BT4560	BATTERY IMPEDANCE METER	56		CT9556	SENSOR UNIT	84	For the CT6841A, etc., ME15W connector
BT5525	BATTERY INSULATION TESTER	66		CT9557	SENSOR UNIT	84	For the CT6841A, etc., ME15W connector
C0106	CARRYING CASE	113	For the FT6031, FT3151 and similar products	CT9667-01	AC FLEXIBLE CURRENT SENSOR	88	φ100 mm (3.94 in)
C0200	CARRYING CASE	100	For the DT4220 series	CT9667-02	AC FLEXIBLE CURRENT SENSOR	88	φ180 mm (7.09 in)
C0201	CARRYING CASE	97	For the DT4250s, DT4210s, FT3424	CT9667-03	AC FLEXIBLE CURRENT SENSOR	88	φ254 mm (10.00 in)
C0202	CARRYING CASE	97	For the DT4280s, DT4250s, DT4210s, FT3424	CT9900	CONVERSION CABLE	69	For the CT6841, PW8001 and similar products
C0203	CARRYING CASE	107	For the CM4370s, and similar products	CT9901	CONVERSION CABLE	85	For the CT6841A and similar products
C0204	CARRYING CASE	101	For the 3244-60	CT9902	EXTENSION CABLE	85	For the CT6841A and similar products
C0205	CARRYING CASE	110	For the CT6280, CM3291/3280-70F and similar products	CT9904	CONNECTION CABLE	69	For the CT9557, PW8001/PW6001/PW3390
C0206	CARRYING CASE	93	For the FT4310	CT9920	CONVERSION CABLE	72	For the PW3390 and similar products
C0207	CARRYING CASE	97	Bag type	DM7275-01	PRECISION DC VOLTMETER	61	
C0220	CARRYING CASE	86	For the CT7600/7700 series	DM7275-02	PRECISION DC VOLTMETER	61	Built-in GP-IB
C0221	CARRYING CASE	86	For the CT7600/7700 series	DM7275-03	PRECISION DC VOLTMETER	61	Built-in RS-232C
C1002	CARRYING CASE	77	For the PQ3198, PQ3100, PW3198	DM7276-01	PRECISION DC VOLTMETER	61	
C1003	CARRYING CASE	19	For the MR8880	DM7276-02	PRECISION DC VOLTMETER	61	Built-in GP-IB
C1004	CARRYING CASE	20	For the MR8875	DM7276-03	PRECISION DC VOLTMETER	61	Built-in RS-232C
C1005	CARRYING CASE	78	For the PW3365/3360s	DSM8104F	INTERLOCK CABLE	--	For the SM7110, SM7120, DSM-8104/8542
C1006	CARRYING CASE	48	For the RM3548	DT4221	DIGITAL MULTIMETER	100	V measurement only, for electrical work
C1007	CARRYING CASE	32	For the LR8410	DT4222	DIGITAL MULTIMETER	100	With C/R measurement, for general use
C1008	CARRYING CASE	78	For PW3365	DT4223	DIGITAL MULTIMETER	100	With resistance measurement, for electrical work
C1009	CARRYING CASE	77	For the PQ3100 and similar products	DT4224	DIGITAL MULTIMETER	100	With C/R measurement, for general use
C1010	CARRYING CASE	19	For the MR6000	DT4252	DIGITAL MULTIMETER	99	10 A direct input
C1011	CARRYING CASE	24	For the SP3000	DT4253	DIGITAL MULTIMETER	99	With mA DC, temperature
C1012	CARRYING CASE	34	For the LR8450	DT4255	DIGITAL MULTIMETER	99	With fused measurement terminals
C1013	CARRYING CASE	24	For the SP7000 series	DT4256	DIGITAL MULTIMETER	99	Multi-functional model, with 10 A direct input
C1014	CARRYING CASE	57	For the BT3554-50 series	DT4261	DIGITAL MULTIMETER	98	Multi-functional, for on-site maintenance
CC-98A	AC MONITOR OUTPUT CABLE	95	For the FT3432	DT4261-90	DIGITAL MULTIMETER/WIRELESS ADAPTER	98	Bundled with the Wireless Adapter Z3210
CC-98D	DC OUTPUT CABLE	95	For the FT3432	DT4281	DIGITAL MULTIMETER	97	Direct and current clamp input terminals
CM3281	AC CLAMP METER	110	Average rectified	DT4282	DIGITAL MULTIMETER	97	10 A direct input
CM3286-50	AC CLAMP POWER METER	79	Wireless Adapter Z3210 not included	DT4900-01	COMMUNICATION PACKAGE (USB)	97	For the DT4280/4250 series
CM3286-90	AC CLAMP POWER METER/WIRELESS ADAPTER	79	Bundled with the Wireless Adapter Z3210	DT4910	THERMOCOUPLES(K)	97	For the DT4280/4253, and similar products
CM3289	AC CLAMP METER	109	True RMS	DT4911	TEST LEAD	100	For the DT4220 series
CM3291	AC CLAMP METER	110	True RMS	FR-RD	INK PEN	--	For the EPR-1FA
CM4001	AC LEAKAGE CLAMP METER	111	Wireless Adapter Z3210 not included	FT3151	ANALOG EARTH TESTER	113	
CM4001-90	AC LEAKAGE CLAMP METER/WIRELESS ADAPTER	111	Bundled with the Wireless Adapter Z3210	FT3424	LUX METER	96	
CM4002	AC LEAKAGE CLAMP METER	111	Wireless Adapter Z3210 not included	FT3425	LUX METER	96	Built in Bluetooth® wireless technology
CM4002-90	AC LEAKAGE CLAMP METER/WIRELESS ADAPTER	111	Bundled with the Wireless Adapter Z3210	FT3432	SOUND LEVEL METER	95	
CM4003	AC LEAKAGE CLAMP METER	111	Wireless Adapter Z3210 not included	FT3470-51	MAGNETIC FIELD HITESTER	94	100 cm <sup>2</sup> Sensor bundled
CM4003-90	AC LEAKAGE CLAMP METER/WIRELESS ADAPTER	111	Bundled with the Wireless Adapter Z3210	FT3470-52	MAGNETIC FIELD HITESTER	94	100 cm <sup>2</sup> Sensor, 3 cm <sup>2</sup> Sensor bundled
CM4141-50	AC CLAMP METER	109	Wireless Adapter Z3210 not included	FT3700-20	INFRARED THERMOMETER	95	Long-focus type
CM4141-90	AC CLAMP METER/WIRELESS ADAPTER	109	Bundled with the Wireless Adapter Z3210	FT3701-20	INFRARED THERMOMETER	95	Long focus, precise-field type
CM4371-50	AC/DC CLAMP METER	107	Wireless Adapter Z3210 not included	FT4310	BYPASS DIODE TESTER	93	Built in Bluetooth® wireless technology
CM4371-90	AC/DC CLAMP METER/WIRELESS ADAPTER	107	Bundled with the Wireless Adapter Z3210	FT6031-50	EARTH TESTER	113	Wireless Adapter Z3210 not included
CM4373-50	AC/DC CLAMP METER	106	Wireless Adapter Z3210 not included	FT6031-90	EARTH TESTER/WIRELESS ADAPTER	113	Bundled with the Wireless Adapter Z3210
CM4373-90	AC/DC CLAMP METER/WIRELESS ADAPTER	106	Bundled with the Wireless Adapter Z3210	FT6380-50	CLAMP ON EARTH TESTER	112	Wireless Adapter Z3210 not included
CM4373-91	AC/DC CLAMP METER SET	106	Bundled with the DC High Voltage Probe P2000	FT6380-90	CLAMP ON EARTH TESTER/WIRELESS ADAPTER	112	Bundled with the Wireless Adapter Z3210
CM4373-92	AC/DC CLAMP METER SET	106	Bundled with DC HIGH VOLTAGE PROBE P2000 and Wireless Adapter Z3210	HS-1-30	EXTERNAL SHUNT	117	30 A, class 0.5%
CM4375-50	AC/DC CLAMP METER	106	Wireless Adapter Z3210 not included	HS-1-50	EXTERNAL SHUNT	117	50 A, class 0.5%
CM4375-90	AC/DC CLAMP METER/WIRELESS ADAPTER	106	Bundled with the Wireless Adapter Z3210	HS-1-75	EXTERNAL SHUNT	117	75 A, class 0.5%
CM4375-91	AC/DC CLAMP METER SET	106	Bundled with the DC High Voltage Probe P2000	HS-1-100	EXTERNAL SHUNT	117	100 A, class 0.5%
CM4375-92	AC/DC CLAMP METER SET	106	Bundled with DC HIGH VOLTAGE PROBE P2000 and Wireless Adapter Z3210	HS-1-150	EXTERNAL SHUNT	117	150 A, class 0.5%
CM7290	DISPLAY UNIT	87	For the CT7000 series	HS-1-200	EXTERNAL SHUNT	117	200 A, class 0.5%
CM7291	DISPLAY UNIT	87	For the CT7000 series, with built-in Bluetooth® wireless technology	HS-1-300	EXTERNAL SHUNT	117	300 A, class 1.0%
CT-5MRN100	CURRENT TRANSFORMER	117	Primary current 100 A, output 5 VA	IM3523	LCR METER	44	
CT-5MRN120	CURRENT TRANSFORMER	117	Primary current 120 A, output 5 VA	IM3523A	LCR METER	44	
CT-5MRN150	CURRENT TRANSFORMER	117	Primary current 150 A, output 5 VA	IM3533	LCR METER	45	

# Model No. (Order Code) Index

Note: D mark : Discontinued or discontinuation scheduled models.

Model No.	Name	Page	Note	Model No.	Name	Page	Note
IM3533-01	LCR METER	45	Advanced function model	L9096	OUTPUT CORD	26	For Logger, CM7290 and similar products
IM3536	LCR METER	44		L9097	CONNECTION CABLE	111	For the CM4003
IM3536-01	LCR METER	44	Special order products up to 10 MHz	L9170-10	TEST LEAD	62	For the SS7012, 3237 series, 3156
IM3570	IMPEDANCE ANALYZER	43		L9197	CONNECTION CORD	26	For the Memory HiCorder series
IM3590	CHEMICAL IMPEDANCE ANALYZER	42	For electrochemical components	L9198	CONNECTION CORD	26	For the Memory HiCorder series
IM7580A-1	IMPEDANCE ANALYZER	41	Connection cable 1 m is bundled	L9207-10	TEST LEAD	97	For the DT4280/4250s, CT4370s, 3256/3281s, and similar products
IM7580A-2	IMPEDANCE ANALYZER	41	Connection cable 2 m is bundled	L9207-30	TEST LEAD	101	For the 3030-10, 3127-10/3128-10, and similar products
IM7581-01	IMPEDANCE ANALYZER	41	Connection cable 1 m is bundled	L9208	TEST LEAD	107	For the 3288, 3287, 3280 series
IM7581-02	IMPEDANCE ANALYZER	41	Connection cable 2 m is bundled	L9217	CONNECTION CORD	26	1.6 m (5.25 ft) length
IM7583-01	IMPEDANCE ANALYZER	40	Connection cable 1 m is bundled	L9217-01	CONNECTION CORD	71	3 m (9.84 ft) length
IM7583-02	IMPEDANCE ANALYZER	40	Connection cable 2 m is bundled	L9217-02	CONNECTION CORD	71	10 m (32.81 ft) length
IM7585-01	IMPEDANCE ANALYZER	40	Connection cable 1 m is bundled	L9243	GRABBER CLIP	26	For the Memory HiCorder, L4930/9197, 9322
IM7585-02	IMPEDANCE ANALYZER	40	Connection cable 2 m is bundled	L9257	CONNECTION CORD	66	For the ST5520, 3154, 8205-10, 8206-10
IM7587-01	IMPEDANCE ANALYZER	39	Connection cable 1 m is bundled	L9300	TEST LEAD	97	For the DT4200 series, CM4000 series and similar products
IM7587-02	IMPEDANCE ANALYZER	39	Connection cable 2 m is bundled	L9438-50	VOLTAGE CORD	69	For the PW8001, PW6001, PW3390
IM9000	EQUIVALENT CIRCUIT ANALYSIS FIRMWARE	43	Factory option firmware for the IM3570	L9438-53	VOLTAGE CORD	78	For the PW3360s, 3169s, and similar products
IM9100	SMD TEST FIXTURE	47	For the IM3536, and similar products	L9438-55	VOLTAGE CORD	--	For the 3197
IM9110	SMD TEST FIXTURE	47	For the IM3570, and similar products	L9500	POWER CABLE	24	For the SP7100
IM9200	TEST FIXTURE STAND	47	For the IM7580 series	L9510	USB CABLE	24	For the SP7150
IM9201	SMD TEST FIXTURE	47	For the IM7580 series	L9635-01	VOLTAGE CORD	--	For the 3286-20
IM9202	TEST FIXTURE	47	For the IM7580 series	L9637	RS-232C CABLE	66	For the BT5525
IM9901	CONTACT TIPS	47	To replace the tip on the L2001	L9769	CONVERSION CABLE	--	Bundled with the U8969, for the MR6000 and similar products
IM9902	CONTACT TIPS	47	To replace the tip on the L2001	L9787	TEST LEAD	103	For the IR4050s/4010s, 3454/53, 3154, FT6031
IM9905	CALIBRATION KIT	47	For the IM7580 series	L9787-91	BREAKER PIN	103	For the L9787/IR4050/4010 series)
IM9906	ADAPTER(3.5mm/7mm)	47	For the IM7580 series	L9788-10	TEST LEAD WITH REMOTE SWITCH (RED)	103	For the IR4050/4010 series
IR3455	HIGH VOLTAGE INSULATION TESTER	105	250 V to 5 kV/ 10 TQ	L9788-11	TEST LEAD SET WITH REMOTE SWITCH	103	For the IR4050/4010 series
IR4016-20	ANALOG MQ HITESTER	104	500 V/ 100 MQ, Test Lead L9787 bundled	L9788-90	TIP PIN	103	For the L9788/-10 (IR4050/4010 series)
IR4017-20	ANALOG MQ HITESTER	104	500 V/ 1000 MQ, Test Lead L9787 bundled	L9788-92	BREAKER PIN	103	For the L9788-10/-11(IR4050/4010 series)
IR4018-20	ANALOG MQ HITESTER	104	1000 V/ 2000 MQ, Test Lead L9787 bundled	L9790	CONNECTION CORD	26	For the Memory HiCorder series
IR4053-10	INSULATION TESTER	103	Bundled with Test Lead L9787	L9790-01	ALLIGATOR CLIP	26	For the L9790 (for the Memory HiCorder series)
IR4056-20	INSULATION TESTER	102	Economic model	L9795-01	CONNECTION CABLE	62	For the U8793, MR6000 and similar products
IR4056-21	INSULATION TESTER	102	Economic model, Not CE marked	L9795-02	CONNECTION CABLE	62	For the U8793, MR6000 and similar products
IR4057-50	INSULATION TESTER	102	Wireless Adapter Z3210 not included	L9820	CONNECTION CABLE	96	For the FT3424, FT3425
IR4057-90	INSULATION TESTER/WIRELESS ADAPTER	102	Bundled with the Wireless Adapter Z3210	L9840	AUXILIARY EARTHING ROD	113	For the FT6031, FT3151
L0220-01	EXTENSION CABLE	86	For the CT7600/7700 series	L9841	MEASUREMENT CABLE	113	For the FT6031, FT3151
L0220-02	EXTENSION CABLE	86	For the CT7600/7700 series	L9842-11	MEASUREMENT CABLE	113	For the FT6031, FT3151
L0220-03	EXTENSION CABLE	86	For the CT7600/7700 series	L9842-22	MEASUREMENT CABLE	113	For the FT6031, FT3151
L0220-04	EXTENSION CABLE	86	For the CT7600/7700 series	L9843-51	MEASUREMENT CABLE	113	For the FT6031, FT3151
L0220-05	EXTENSION CABLE	86	For the CT7600/7700 series	L9843-52	MEASUREMENT CABLE	113	For the FT6031, FT3151
L0220-06	EXTENSION CABLE	86	For the CT7600/7700 series	L9844	MEASUREMENT CABLE	113	For the FT6031, FT3151
L0220-07	EXTENSION CABLE	86	For the CT7600/7700 series	L9910	CONVERSION CABLE	77	For the PQ3100
L1000	VOLTAGE CORD	69	For the PW8001, PW6001, PQ3198	LR5001	HUMIDITY LOGGER	38	Temperature / Humidity each 1ch
L1000-05	VOLTAGE CORD	77	For the PQ3100	LR5011	TEMPERATURE LOGGER	38	Temperature 1ch
L1002	USB CABLE(A-B)	61	For the DM7276 and similar products	LR5031	INSTRUMENTATION LOGGER	37	mADC, 1ch
L1010	CONNECTION CABLE	31	For the LR8512	LR5041	VOLTAGE LOGGER (50mV)	37	±50mV DC
L1011	CONVERSION CABLE	25	For the P9000 and similar products	LR5042	VOLTAGE LOGGER (5V)	37	±5V DC
L1011-10	CONVERSION CABLE	25	For the P9000 and similar products	LR5043	VOLTAGE LOGGER (50V)	37	±50V DC
L1021-01	PATCH CORD	72	For the PW3390 and similar products	LR5051	CLAMP LOGGER	36	2ch, clamp sensor is sold separately
L1021-02	PATCH CORD	72	For the PW3390 and similar products	LR5091	COMMUNICATION ADAPTER	36	For the LR5000 series
L1025	VOLTAGE CORD	69	For the PW8001	LR5092-20	DATA COLLECTOR	36	For the LR5000 series
L1050-01	VOLTAGE CORD	71	1.6 m (5.25 ft) length	LR8410-20	WIRELESS LOGGING STATION	32	English model, main unit only
L1050-03	VOLTAGE CORD	71	3 m (9.84 ft) length	LR8410-30	WIRELESS LOGGING STATION	--	Chinese model, main unit only
L2000	4-TERMINAL PROBE	47	For the IM3590/IM3570, 3506-10, 3505/06	LR8431-20	MEMORY HILOGGER	35	10 ch, English model
L2001	PINCHER PROBE	47	For the IM3523, and similar products	LR8431-30	MEMORY HILOGGER	--	10ch, Chinese model
L2002	CLIP TYPE PROBE	56	For the BT4560, 1.5 m (4.92 ft) length	LR8432-20	HEAT FLOW LOGGER	31	10 ch, English model
L2003	PIN TYPE PROBE	56	For the BT4560, 1.5 m (4.92 ft) length	LR8432-30	HEAT FLOW LOGGER	--	10 ch, Chinese model
L2004	CONNECTION CABLE	52	SW1001 and similar products	LR8450	MEMORY HILOGGER	33	Standard model (Plug-in model), main unit only
L2020	PIN TYPE LEAD	57	For the BT3554-50	LR8450-01	MEMORY HILOGGER	33	Wireless LAN equipped model, main unit only
L2100	PIN TYPE LEAD	53	For the BT3562, BT3563	LR8510	WIRELESS VOLTAGE/TEMP UNIT	32	For the LR8410
L2101	CLIP TYPE LEAD	49	For the RM3544, RM3545 series	LR8511	WIRELESS UNIVERSAL UNIT	32	For the LR8410
L2102	PIN TYPE LEAD	49	For the RM3544, RM3545 series	LR8512	WIRELESS PULSE LOGGER	31	2 ch
L2103	PIN TYPE LEAD	49	For the RM3544, RM3545 series	LR8513	WIRELESS CLAMP LOGGER	30	2 ch, sensor is sold separately
L2104	4-TERMINAL LEAD	49	For the RM3544, RM3545 series	LR8514	WIRELESS HUMIDITY LOGGER	30	2 ch, sensor is sold separately
L2105	LED COMPARATOR ATTACHMENT	49	For the RM3544, RM3545 series, RM3548	LR8515	WIRELESS VOLTAGE/TEMP LOGGER	29	2 ch, sensor is sold separately
L2107	CLIP TYPE LEADS	48	For the RM3548, 3561/60, 3541/40 and similar products	LR8520	WIRELESS FUNGAL LOGGER	29	Humidity sensor is sold separately
L2108	CONNECTION CABLE	52	SW1001 and similar products	LR8530	WIRELESS VOLTAGE/TEMP UNIT	34	For the LR8450-01
L2110	PIN TYPE LEAD	53	For the BT3562(-01), BT3563(-01), BT3564	LR8531	WIRELESS UNIVERSAL UNIT	34	For the LR8450-01
L2130	CLIP TYPE LEAD	66	For the BT5525	LR8532	WIRELESS VOLTAGE/TEMP UNIT	34	For the LR8450-01
L2131	CLIP TYPE LEAD	66	For the BT5525	LR8533	WIRELESS HIGH SPEED VOLTAGE UNIT	34	For the LR8450-01
L2132	UNTERMINATED LEAD L2132	66	For the BT5525	LR8534	WIRELESS STRAIN UNIT	34	For the LR8450-01
L2133	UNTERMINATED LEAD L2132	66	For the BT5525	LR8535	WIRELESS CAN UNIT	34	For the LR8450-01
L2200	TEST LEAD	64	For the ST5540/ST5541, MR8990	LR9501	HUMIDITY SENSOR	38	For the LR5001
L2220	CONNECTOR	58	For the SM7810	LR9502	HUMIDITY SENSOR	38	For the LR5001
L2221	CONNECTOR	58	For the SM7860	LR9503	HUMIDITY SENSOR	38	For the LR5001
L2230	PIN TYPE LEAD (RED)	59	For the SM7110 and similar products	LR9504	HUMIDITY SENSOR	38	For the LR5001
L2231	PIN TYPE LEAD (BLACK)	59	For the SM7110 and similar products	LR9601	TEMPERATURE SENSOR	38	For the LR5011
L2232	CLIP TYPE LEAD (RED)	59	For the SM7110 and similar products	LR9602	TEMPERATURE SENSOR	38	For the LR5011
L2233	CLIP TYPE LEAD (BLACK)	59	For the SM7110 and similar products	LR9603	TEMPERATURE SENSOR	38	For the LR5011
L2234	OPEN LEAD (RED)	59	For the SM7110 and similar products	LR9604	TEMPERATURE SENSOR	38	For the LR5011
L2235	OPEN LEAD (BLACK)	59	For the SM7110 and similar products	LR9611	TEMPERATURE SENSOR	38	For the LR5011
L2250	CLIP TYPE LEAD	63	For the ST4030A, ST4030	LR9612	TEMPERATURE SENSOR	38	For the LR5011
L2252	UNPROCESSED LEAD CABLE	63	For the ST4030A	LR9613	TEMPERATURE SENSOR	38	For the LR5011
L4930	CONNECTION CABLE SET	97	For the DT4280/DT4250 series	LR9621	TEMPERATURE SENSOR	38	For the LR5011
L4931	EXTENSION CABLE SET	26	For the L4930/L4940	LR9631	TEMPERATURE SENSOR	38	For the LR5011
L4932	TEST PIN SET	97	For the L4930/L4940/L4942	LR9801	CONNECTION CABLE	37	For the LR5031
L4933	CONTACT PIN SET	97	For the L9207-10, DT4911(DT4280/4250s)	LR9802	CONNECTION CABLE	37	For the LR5041, LR5042, LR5043 and LR5061
L4934	SMALL ALLIGATOR CLIP SET	97	For the L4932, L9207-10, DT4911(DT4280/4250s)	LR9901	WALL-MOUNTED HOLDER	38	For the LR5000 series (cannot use with the LR5051)
L4935	ALLIGATOR CLIP SET	26	For the L4930/L4940 (DT4280/4250s)	MR6000	MEMORY HICORDER	19	Main unit only, input modules up to 8 units
L4936	BUS BAR CLIP SET	97	For the L4930/L4940 (DT4280/4250s)	MR6000-01	MEMORY HICORDER	19	Built-in real-time waveform calculation and other functionality
L4937	MAGNETIC ADAPTER SET	97	For the L4930/L4940 (DT4280/4250s)	MR8740	MEMORY HICORDER	23	Max. 54ch, 864MW memory, main unit only
L4938	TEST PIN SET	97	For the L4930 (DT4280/4250s)	MR8740-50	MEMORY HICORDER	22	Max. 108ch, 1GW memory, main unit only
L4939	BREAKER PIN SET	97	For the L4930 (DT4280/4250s)	MR8741	MEMORY HICORDER	23	Max. 16ch, 256MW memory, main unit only
L4940	CONNECTION CABLE SET	26	For the MR8905	MR8790	WAVEFORM GENERATOR UNIT	62	For the MR8847A and similar products
L4943	CONNECTION CABLE SET	98	For the P2000	MR8791	PULSE GENERATOR UNIT	62	For the MR8847A and similar products
L6000	OPTICAL CONNECTION CABLE	69	For the PW8001/PW6001	MR8827	MEMORY HICORDER	21	Max. 32ch, 512MW memory, main unit only
L9094	OUTPUT CORD	26	For Memory HiCorder, CM7290 and similar products	MR8847-51	MEMORY HICORDER	21	Max. 16ch, 64MW memory, main unit only
L9095	OUTPUT CORD	26	For Memory HiCorder, CM7290 and similar products	MR8847-52	MEMORY HICORDER	21	Max. 16ch, 256MW memory, main unit only

# Model No. (Order Code) Index

Note: D mark : Discontinued or discontinuation scheduled models.

Model No.	Name	Page	Note	Model No.	Name	Page	Note
MR8847-53	MEMORY HICORDER	21	Max. 16ch, 512MW memory, main unit only	RM3542	RESISTANCE HITESTER	50	
MR8870-20	MEMORY HICORDER	20	2ch, English model	RM3542-01	RESISTANCE HITESTER	50	Built in GP-IB interface
MR8870-30	MEMORY HICORDER	--	2ch, Chinese model	RM3542-50	RESISTANCE METER	50	
MR8875	MEMORY HICORDER	20	Max. 16 - 60ch, 32MW memory, main unit only	RM3542-51	RESISTANCE METER	50	Built in GP-IB interface
MR8875-30	MEMORY HICORDER	--	Chinese model	RM3543	RESISTANCE HITESTER	49	
MR8880-20	MEMORY HICORDER	19	4ch, printer unit option, English model	RM3543-01	RESISTANCE HITESTER	49	Built in GP-IB interface
MR8880-21	MEMORY HICORDER	--	4ch, printer unit option, Chinese model	RM3544	RESISTANCE METER	49	No interfaces
MR8901	ANALOG UNIT	20	For the MR8875	RM3544-01	RESISTANCE METER	49	Built in EXT I/O, RS-232C, USB
MR8902	VOLTAGE/TEMP UNIT	20	For the MR8875	RM3545	RESISTANCE METER	48	
MR8903	STRAIN UNIT	20	For the MR8875	RM3545-01	RESISTANCE METER	48	Built-in GP-IB interface
MR8904	CAN UNIT	20	For the MR8875	RM3545-02	RESISTANCE METER	48	Support for the multiplexer unit
MR8905	ANALOG UNIT	20	For the MR8875	RM3548	RESISTANCE METER	48	
MR8990	DIGITAL VOLTMETER UNIT	61	For the MR6000, MR8740, MR8847A, MR8827, and similar products	RM9006	MAINTENANCE TOOL	51	For the RM2610
MR9000	PRINTER UNIT	19	For the MR8880	RM9010-01	FOUR-POINT ARRAY PROBE	48	For the RM3545s
MR9321-01	LOGIC PROBE	26	For the Memory HiCorder, miniature terminal type	RM9010-02	FOUR-POINT ARRAY PROBE	48	For the RM3545s
P-1201A	FELT PEN (RED)	--	For the PR8111, INR-9000, EPR-3000 series	SA2631-01	3-DAY LICENSE	51	License card, for the Slurry Analytical System
P-1201B	FELT PEN (RED)	--	For the INR-9000, EPR-3000 series	SA2631-03	30-DAY LICENSE	51	License card, for the Slurry Analytical System
P-1201C	FELT PEN (RED)	--	For the INR-9000, EPR-3000 series	SA2631-05	365-DAY LICENSE	51	License card, for the Slurry Analytical System
P-1202A	FELT PEN (GREEN)	--	For the PR8111, INR-9000, EPR-3000 series	SA9001	ELECTRODE CELL	51	For the Slurry Analytical System
P-1202C	FELT PEN (GREEN)	--	For the INR-9000, EPR-3000 series	SA9002	TEST FIXTURE	51	For the Slurry Analytical System
P-1203A	FELT PEN (BLUE)	--	For the PR8111, INR-9000, EPR-3000 series	SE-10	RECORDING PAPER	26	For the PR8111/12, EPR-3500 series, EPR-10B
P-1203C	FELT PEN (BLUE)	--	For the INR-9000, EPR-3000 series	SE-10Z-2	RECORDING PAPER	26	For the PR8111/12, EPR-3500 series, EPR-10B
P-1204A	FELT PEN (BROWN)	--	For the INR-9000, EPR-3000 series	SF-10CXZ-35	-	26	For the INR-9000
P-1205A	FELT PEN (BLACK)	--	For the INR-9000 series	SF-10PXZ-45	-	26	For the PRR-5000
P2000	DC HIGH VOLTAGE PROBE	98	2000 V compatible	SF1001	POWER LOGGER VIEWER	78	For the PW3360/3365s, 3169s
P9000-01	DIFFERENTIAL PROBE	25	For the Memory HiCorder series, Wave only	SF4000	GENNECT One	119	Application for Windows
P9000-02	DIFFERENTIAL PROBE	25	For the Memory HiCorder series, Wave/RMS	SF4071	GENNECT Cross	118	Mobile app for iOS
PD3129	PHASE DETECTOR	115		SF4072	GENNECT Cross	118	Mobile app for Android
PD3129-10	PHASE DETECTOR	115	Large clips	SF4180	GENNECT Cloud	119	Free plan with basic functions
PD3129-31	PHASE DETECTOR	--	Chinese model	SF4181-01	GENNECT Cloud Standard	119	GENNECT Cloud Standard 1 month license
PD3129-32	PHASE DETECTOR	--	Large clips, Chinese model	SF4181-03	GENNECT Cloud Standard	119	GENNECT Cloud Standard 3 months license
PD3259-50	DIGITAL PHASE DETECTOR	114	Wireless Adapter Z3210 not included	SF4181-12	GENNECT Cloud Standard	119	GENNECT Cloud Standard 12 months license
PD3259-90	DIGITAL PHASE DETECTOR/WIRELESS ADAPTER	114	Bundled with the Wireless Adapter Z3210	SF4182-01	GENNECT Cloud Pro	119	GENNECT Cloud Pro 1 month license
QQ3100	POWER QUALITY ANALYZER	76	Main unit, current sensor is sold separately	SF4182-03	GENNECT Cloud Pro	119	GENNECT Cloud Pro 3 months license
QQ3100-91	POWER QUALITY ANALYZER KIT	76	Kit includes 600 A sensor x 2 and other options	SF4182-12	GENNECT Cloud Pro	119	GENNECT Cloud Pro 12 months license
QQ3100-92	POWER QUALITY ANALYZER KIT	76	Kit includes 600 A sensor x 4 and other options	SG-10Z	-	26	For the FBR-250 series
QQ3100-94	POWER QUALITY ANALYZER KIT	76	Kit includes 6000 A sensor x 4 and other options	SH-OZ-T1	-	26	For the PSR-2101
QQ3198	POWER QUALITY ANALYZER	76	Main unit, current sensor is sold separately	SM7110	SUPER MEGOHM METER	59	1 ch, 1000 V output
QQ3198-92	POWER QUALITY ANALYZER KIT	76	Kit includes 600 A sensor x 4 and other options	SM7120	SUPER MEGOHM METER	59	1 ch, 2000 V output
QQ3198-94	POWER QUALITY ANALYZER KIT	76	Kit includes 6000 A sensor x 4 and other options	SM7420	SUPER MEGOHM METER	59	4ch, Dedicated micro current measurement
PR-1RD	SOFT PEN (RED)	--	For the EPR-151/152/131/132/133	SM7810	SUPER MΩ HITESTER	58	100/110V AC power supply
PR-2GN	SOFT PEN (GREEN)	--	For the EPR-151/152/131/132/133	SM7810-20	SUPER MΩ HITESTER	58	220V AC power supply
PW3335	POWER METER	74	Built-in LAN, RS-232C	SM7860-51	POWER SOURCE UNIT	58	100V AC power supply
PW3335-01	POWER METER	74	Built-in LAN, GP-IB	SM7860-52	POWER SOURCE UNIT	58	100V AC power supply
PW3335-02	POWER METER	74	Built-in LAN, RS-232C, D/A output	SM7860-53	POWER SOURCE UNIT	58	100V AC power supply
PW3335-03	POWER METER	74	Built-in LAN, RS-232C, external sensor terminal	SM7860-54	POWER SOURCE UNIT	58	100V AC power supply
PW3335-04	POWER METER	74	Built-in LAN, RS-232C, GP-IB, D/A output, external sensor terminal	SM7860-55	POWER SOURCE UNIT	58	100V AC power supply
PW3336	POWER METER	73	2ch	SM7860-56	POWER SOURCE UNIT	58	100V AC power supply
PW3336-01	POWER METER	73	2ch, built-in GP-IB	SM7860-57	POWER SOURCE UNIT	58	100V AC power supply
PW3336-02	POWER METER	73	2ch, built-in D/A output	SM7860-58	POWER SOURCE UNIT	58	100V AC power supply
PW3336-03	POWER METER	73	2ch, built-in GP-IB, D/A output	SM7860-61	POWER SOURCE UNIT	58	220V AC power supply
PW3337	POWER METER	73	3ch	SM7860-62	POWER SOURCE UNIT	58	220V AC power supply
PW3337-01	POWER METER	73	3ch, built-in GP-IB	SM7860-63	POWER SOURCE UNIT	58	220V AC power supply
PW3337-02	POWER METER	73	3ch, built-in D/A output	SM7860-64	POWER SOURCE UNIT	58	220V AC power supply
PW3337-03	POWER METER	73	3ch, built-in GP-IB, D/A output	SM7860-65	POWER SOURCE UNIT	58	220V AC power supply
PW3360-20	CLAMP ON POWER LOGGER	78	English model, main unit only	SM7860-66	POWER SOURCE UNIT	58	220V AC power supply
PW3360-21	CLAMP ON POWER LOGGER	78	English model, with harmonic analysis function	SM7860-67	POWER SOURCE UNIT	58	220V AC power supply
PW3360-30	CLAMP ON POWER LOGGER	--	Chinese model, main unit only	SM7860-68	POWER SOURCE UNIT	58	220V AC power supply
PW3360-31	CLAMP ON POWER LOGGER	--	Chinese model, with harmonic analysis function	SM9001	SURFACE VOLUME RESISTANCE MEASUREMENT ELECTRODE	60	For the SM-8200 series
PW3365-20	CLAMP ON POWER LOGGER	77	English model, main unit only	SM9002	VERIFICATION FIXTURE FOR SURFACE RESISTANCE MEASUREMENT	60	For the SM9001(SM-8200 series)
PW3365-30	CLAMP ON POWER LOGGER	--	Chinese model, main unit only	SME-8301	SURFACE RESISTANCE MEASUREMENT ELECTRODE	60	
PW3390-01	POWER ANALYZER	71		SME-8302	ELECTRODE FOR SURFACE RESISTANCE	60	
PW3390-02	POWER ANALYZER	71	D/A output	SME-8310	PLATE SAMPLE ELECTRODE	60	
PW3390-03	POWER ANALYZER	71	D/A output, motor analysis	SME-8311	ELECTRODE FOR FLAT SAMPLE	60	
PW6001-01	POWER ANALYZER	70	1ch	SME-8320	WEIGHT ELECTRODE	60	
PW6001-02	POWER ANALYZER	70	2ch	SME-8330	LIQUID SAMPLE ELECTRODE	60	
PW6001-03	POWER ANALYZER	70	3ch	SME-8350	SHIELDING BOX	60	
PW6001-04	POWER ANALYZER	70	4ch	SME-8360	ELECTRODE FOR CHIP CAPACITOR	60	
PW6001-05	POWER ANALYZER	70	5ch	SP3000	NON-CONTACT AC VOLTAGE PROBE	24	Sold individually
PW6001-06	POWER ANALYZER	70	6ch	SP3000-01	NON-CONTACT AC VOLTAGE PROBE	24	SP3000, SP9001 bundled model
PW6001-11	POWER ANALYZER	70	1ch, motor analysis, D/A output	SP7001	NON-CONTACT CAN SENSOR	24	Sensor box only, supports CAN FD / CAN signals
PW6001-12	POWER ANALYZER	70	2ch, motor analysis, D/A output	SP7001-90	NON-CONTACT CAN SENSOR	24	Supports CAN FD / CAN signals, SP7001, SP7100, SP9200 set
PW6001-13	POWER ANALYZER	70	3ch, motor analysis, D/A output	SP7001-95	NON-CONTACT CAN SENSOR	24	Supports CAN FD / CAN signals, SP7001, SP9250, SP7150 set
PW6001-14	POWER ANALYZER	70	4ch, motor analysis, D/A output	SP7002	NON-CONTACT CAN SENSOR	24	Sensor box only, supports CAN signals
PW6001-15	POWER ANALYZER	70	5ch, motor analysis, D/A output	SP7002-90	NON-CONTACT CAN SENSOR	24	Supports CAN signals, SP7002, SP7100, SP9250 set
PW6001-16	POWER ANALYZER	70	6ch, motor analysis, D/A output	SP7100	CAN INTERFACE	24	For the SP7001, SP7002
PW8001-01	POWER ANALYZER	69		SP7150	CAN INTERFACE	24	For the SP7001, SP7002
PW8001-02	POWER ANALYZER	69	D/A output	SP9001	AC VOLTAGE PROBE	24	Sold individually
PW8001-03	POWER ANALYZER	69	CAN	SP9200	SIGNAL PROBE	24	For the SP7001, SP7002, screw type
PW8001-04	POWER ANALYZER	69	Optical link	SP9250	SIGNAL PROBE	24	For the SP7001, SP7002, trigger type
PW8001-05	POWER ANALYZER	69	D/A output, Optical link	SP9900	SPLIT CABLE	24	For the SP7100
PW8001-06	POWER ANALYZER	69	CAN, Optical link	SR-2	STANDARD RESISTOR	60	
PW8001-11	POWER ANALYZER	69	Motor analysis	SS7012	DC SIGNAL SOURCE	62	
PW8001-12	POWER ANALYZER	69	Motor analysis, D/A output	SS7081-50	BATTERY CELL VOLTAGE GENERATOR	52	
PW8001-13	POWER ANALYZER	69	Motor analysis, CAN	SS9000	COMMUNICATION PACKAGE	62	For the SS7012
PW8001-14	POWER ANALYZER	69	Motor analysis, Optical link	ST-80	SOUND LEVEL METER TRIPOD	95	For the FT3432, 3431/30
PW8001-15	POWER ANALYZER	69	Motor analysis, D/A output, Optical link	ST-80-100	TRIPOD EXTENSION ROD	95	For the FT3432, 3431/30
PW8001-16	POWER ANALYZER	69	Motor analysis, CAN, Optical link	ST4030A	IMPULSE WINDING TESTER	63	
PW9000	WIRING ADAPTER	72	For the PW3390, PQ3198/3196 and similar products	ST5520	INSULATION TESTER	66	Built-in external I/O output
PW9001	WIRING ADAPTER	72	For the PW3390, PQ3198/3196 and similar products	ST5520-01	INSULATION TESTER	66	Built-in BCD output
PW9002	BATTERY SET	78	For the PW3360/PW3365	ST5540	LEAK CURRENT HITESTER	64	For medical-use and electrical devices
PW9003	VOLTAGE LINE POWER ADAPTER	78	For the PW3360	ST5541	LEAK CURRENT HITESTER	64	For electrical devices
PW9005	GPS BOX	77	For the PQ3198, PW3198	ST9000	DISCHARGE DETECTION UPGRADE	63	Factory option firmware for the ST4030A
PW9020	SAFETY VOLTAGE SENSOR	78	For PW3365	SW1001	SWITCH MAINFRAME	52	3 slots
PW9100A-3	AC/DC CURRENT BOX	72	For the PW8001/PW6001/PW3390, 3 ch	SW1002	SWITCH MAINFRAME	52	12 slots
PW9100A-4	AC/DC CURRENT BOX	72	For the PW8001/PW6001/PW3390, 4 ch	SW9001	MULTIPLEXER MODULE	52	For SW1001 and similar products
RM2610	ELECTRODE RESISTANCE MEASUREMENT SYSTEM	51	System product	SW9002	MULTIPLEXER MODULE	52	For SW1001 and similar products

# Model No. (Order Code) Index

Note: D mark : Discontinued or discontinuation scheduled models.

Model No.	Name	Page	Note	Model No.	Name	Page	Note
TM6101	LED OPTICAL METER	90	For production line				
TM6102	RGB LASER METER	90	Illuminance				
TM6103	RGB LASER LUMINANCE METER	90	Luminance				
TM6104	OPTICAL POWER METER	90	Optical power				
TS2400	WPT TEST SYSTEM	120	System product				
U7001	2.5MS/S INPUT UNIT	69	For the PW8001				
U7005	15MS/S INPUT UNIT	69	For the PW8001				
U8330	SSD UNIT	21	For the MR8827, factory option				
U8331	SSD UNIT	21	For the MR8847A, factory option				
U8332	SSD UNIT	19	For the MR6000, factory option				
U8333	HD UNIT	19	For the MR6000, factory option				
U8350	PRINTER UNIT	21	For the MR8827, factory option				
U8550	VOLTAGE/TEMP UNIT	34	For the LR8450, LR8450-01				
U8551	UNIVERSAL UNIT	34	For the LR8450, LR8450-01				
U8552	VOLTAGE/TEMP UNIT	34	For the LR8450, LR8450-01				
U8553	HIGH SPEED VOLTAGE UNIT	34	For the LR8450, LR8450-01				
U8554	STRAIN UNIT	34	For the LR8450, LR8450-01				
U8555	CAN UNIT	34	For the LR8450, LR8450-01				
U8793	ARBITRARY WAVEFORM GENERATOR UNIT	62	For the MR8847A and similar products				
U8794	VIR GENERATOR UNIT	62	For the MR8740-50				
U8969	STRAIN UNIT	19	For the MR6000, MR8847A, MR8827, and similar products				
U8974	HIGH VOLTAGE UNIT	19	For the MR6000, MR8847A, MR8827, and similar products				
U8975	4CH ANALOG UNIT	19	For the MR6000 and similar products				
U8976	HIGH SPEED ANALOG UNIT	19	For the MR6000 and similar products				
U8977	3CH CURRENT UNIT	19	For the MR6000 and similar products				
U8978	4CH ANALOG UNIT	19	For the MR6000 and similar products				
U8979	CHARGE UNIT	19	For the MR6000 and similar products				
U8991	DIGITAL VOLTMETER UNIT	61	For the MR8740-50				
VT1005	AC/DC HIGH VOLTAGE DIVIDER	71	For the PW8001, PW6001, PW3390				
Z1000	BATTERY PACK	19	For the MR8880, LR8400 series				
Z1002	AC ADAPTER	19	For the MR8880, MR8875, PQ3198				
Z1003	BATTERY PACK	20	For the MR8875, PQ3198/PW3198, PQ3100				
Z1005	AC ADAPTER	20	For the MR8870/8870, LR8431/8430 series				
Z1006	AC ADAPTER	78	For the PW3360 series				
Z1007	BATTERY PACK	32	For the LR8410 and similar products				
Z1008	AC ADAPTER	32	For the LR8410, PW3365 series, P9000 and similar products				
Z1009	FIXED STAND	32	For the LR8410 series				
Z1013	AC ADAPTER	24	For the SP3000				
Z1014	AC ADAPTER	34	For the LR8450 and similar products				
Z2000	HUMIDITY SENSOR	32	For the LR8410/LR8400 series				
Z2001	TEMPERATURE SENSOR	48	For the RM3545 series and similar products				
Z2002	TEMPERATURE SENSOR	48	For the RM3548				
Z2003	AC ADAPTER	31	For the LR8512 series				
Z2005	TEMPERATURE SENSOR	56	For the BT4560, 1 m (3.28 ft) length				
Z2010	HUMIDITY SENSOR	30	For the LR8514				
Z2011	HUMIDITY SENSOR	30	For the LR8514				
Z3000	GP-IB INTERFACE	42	For the IM3590, IM3523/33 series				
Z3001	RS-232C INTERFACE	42	For the IM3590, IM3523/33 series				
Z3002	LAN INTERFACE	42	For the IM3590, IM3523/33 series				
Z3003	MULTIPLEXER UNIT	48	For the RM3545-02, input scanner				
Z3210	WIRELESS ADAPTER	118	For the CM4001, FT6031-50 etc.				
Z3230	WIRELESS LAN ADAPTER	34	For the LR8530 series				
Z4001	SD MEMORY CARD 2GB	26	For the PQ3198, PQ3100, MR8875 and similar products				
Z4003	SD MEMORY CARD	26	For the PQ3198, PQ3100, MR8875 and similar products, 8GB				
Z4006	USB DRIVE	26	For the MR6000 and similar products, 16GB				
Z5003	CONTACT ADAPTER	--	For the FT3405, FT3406				
Z5004	MAGNETIC STRAP	77	For the PQ3198, PQ3100, LR5000 series and similar products				
Z5008	THERMALLY CONDUCTIVE TAPE	--	For the Z2012s, 20 seats set				
Z5010	CONVERSION ADAPTER	59	For the SM7110, SM7120 and similar products				
Z5015	PC SYSTEM	120	For the TS2400				
Z5016	WPT TESTING PLATFORM	120	For the TS2400				
Z5017	PLC RACK	120	For the TS2400				
Z5018	SWITCH BOX	120	For the TS2400				
Z5020	MAGNETIC STRAP	114	For the PD3259-50, DT4250/4280 series				
Z5021	PROBE POWER UNIT	19	For the MR6000, factory option				
Z5022	SHOULDER STRAP	113	For the FT3151				
Z5023	EXTENSION CART	96	For the FT3424, FT3425				
Z5038	0 ADJ BOARD	54	For the L2100, L2110 (BT3564) and similar products				
Z5040	FIXED STAND	34	For the LR8450, LR8450-01				
Z5041	PROTECTOR	57	For the BT3554-50 series				
Z5050	FUSE SET	57	For the BT3554-50 series				



## Product warranties

**HIOKI products are generally covered by a three-year warranty.**

Product warranty	In the event HIOKI is responsible for the failure of a product during the warranty term beginning on the date of purchase (or beginning in the month the product was manufactured if the date of purchase is unclear), we will repair or replace the product free of charge.
Warranty scope	We check products on a standalone basis to verify their specifications, performance, and functionality. Although we verify proper operation of components that are connected to HIOKI products in standard configurations, we ask that customers verify proper operation of their HIOKI products when connected to other manufacturers' products. The scope of HIOKI's warranty is limited to HIOKI products. Connected devices and issues caused by connected devices are considered outside the scope of the warranty. In the event of physical damage, any compensation that might be provided by HIOKI is limited to the purchase price of the product
Accuracy guarantee	For products with an accuracy guarantee, we guarantee the level of accuracy indicated in the specifications for a certain period of time following shipment from the factory. In the event of an accuracy defect during that period of time, we will adjust the product free of charge.

## Calibration and repair service

Calibration Expiration (Calibration Interval)	Values obtained on the date of calibration are used as the calibration results. When calibration expires (i.e., the calibration interval) depends on the customer's operating conditions and environment. Consequently, the customer is ultimately responsible for determining calibration expiration while taking into account the calibration interval recommended by Hioki.
Recommended calibration interval	Hioki recommends that each product's accuracy guarantee period be treated as the recommended calibration interval.
Guarantee after Calibration Service*1	If a customer reports a loss of accuracy after calibration while the instrument in question is covered by the recommended calibration interval and we are able to verify the issue, we will adjust the instrument free of charge. (If the product is subject to a regular calibration request, we will adjust it as part of the calibration fee.)
Guarantee Conditions	<ul style="list-style-type: none"> <li>• If a loss of accuracy is caused by a part's having reached its service life or deteriorated, fees will apply to the repair.</li> <li>• If the loss of accuracy is deemed likely to have been caused by damage or by the operating or storage environment, fees will apply to the repair.</li> <li>• If a product is deemed likely to experience a loss of accuracy after shipment, for example due to the end of the repair period, we may contact the customer and decline to offer a guarantee.</li> <li>• The guarantee applies to products that are calibrated at Hioki.</li> </ul>
Guarantee of repaired products	If, within six months of the original repair, HIOKI is responsible for an issue requiring an additional repair (a repair of the same issue) of a product that has been used as described in its user manual, we will repair it free of charge.
Repair term	<p>We may improve products or switch models without notice in order to enhance the competitiveness of our products and our productivity. We will repair discontinued products for a minimum of five years from the date of their discontinuation, although we may elect to propose that the customer switch to an alternative model if it is difficult to repair a product due to social or economic conditions.</p> <p>*Once five years have passed since a product's discontinuation, we will only accept inspection and calibration requests for that product if we are able to perform that work in-house.</p>

\*1: Not all products are covered by this guarantee.

## Quality of HIOKI's calibration and repair service

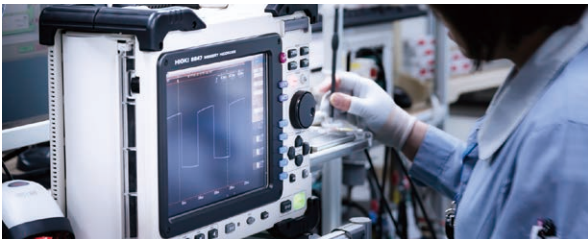

### 80 years of history and fine-grained, expert service

Technicians performing calibration, adjustment, and repair work undergo in-house training to ensure they possess the specialized expertise and skills that such work demands.

### Precise calibration and adjustment guidelines compiled by product designers

We determine everything from the procedures for measuring instrument functionality checks to calibration points based on the results of reviews conducted by designers who are well versed in the characteristics of products' internal circuitry and the principles that underlie their operation. In this way, we are able to provide optimal, extensive calibration and adjustment service as only the manufacturer can.

### Highly reliable service that's traceable to national standards

The standard devices we use to calibrate and adjust products are all linked to national standards, ensuring that we can issue inspection reports with accurate, reliable calibrated values.

### Comprehensive calibration and repair service with fast turnaround

If we discover a malfunction or failure during the calibration process, we'll contact you to let you know where the problem is and what's necessary to address it. If you wish, we'll then repair the product. This capability eliminates unnecessary back-and-forth so you can put your product back to work as soon as possible.

## Traceability Chart

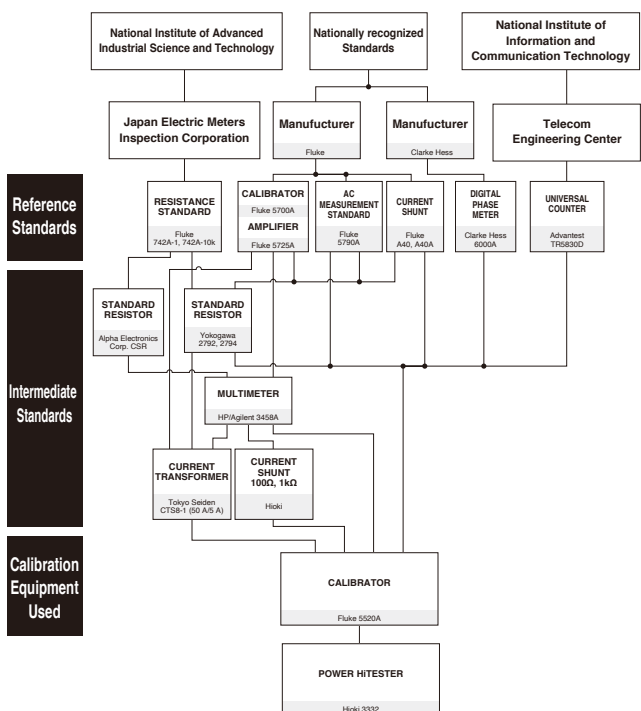

Other

# Calibration and Repair Service

## (1) Service content

Hioki's calibration services were updated effective April 2022.

### "Calibration Services"

When an instrument is calibrated and its measured values are found not to satisfy internal Hioki standards, the instrument is adjusted. Through the ongoing use of calibration services offered as only an instrument manufacturer can, customers are able to use their instruments with peace of mind while maintaining their precision.

This calibration service will allow us to return products to customers with minimal downtime, since there are no work interruptions.

### Notes

\*If you do not wish your instrument to be adjusted, please let us know when you request calibration. Your product will be returned without adjustment, even if the calibration report indicates a FAIL judgment (non-compliance).

\*This service does not extend to products that cannot be adjusted or to discontinued products.

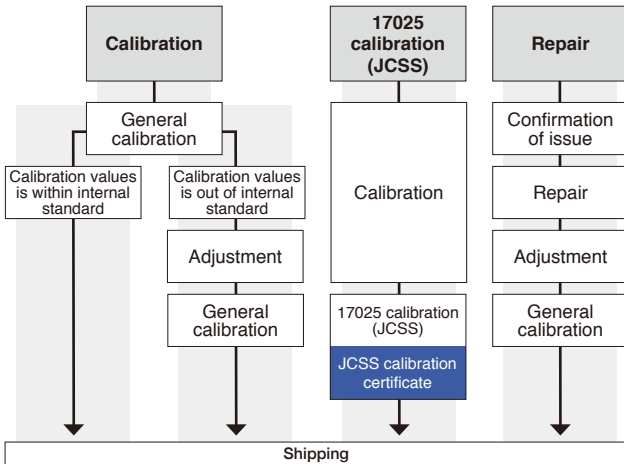

\*JCSS calibration is also available as a standalone service

## (2) Documents we can issue and their content

Sample documents are also available on Hioki's website.



Test report

- Calibration results
- Judgment



General calibration certificate

- Calibration certificate declaration
- Information about equipment used in calibration



JCSS calibration certificate

- Calibration results
- Coverage factor
- Calibration certificate declaration
- ilac-MRA, IA Japan, and JCSS logos



Traceability certificate (special-order)

- Calibration certificate declaration
- Information about lighting standards

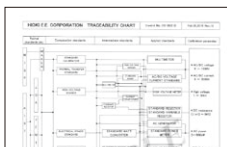

Traceability chart (overall)

An overview tracing HIOKI product groups to national standards via individual standard devices

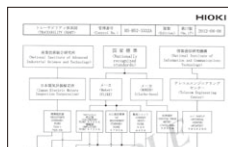

Traceability chart (model-specific)

A detailed diagram tracing a particular product model to national standards via individual standard devices

## Calibration

Calibration provides a way to check the condition of a measuring instrument by comparing the ideal value indicated by a standard device with the value indicated by the instrument being calibrated.

## Adjustment

Calibration values will be optimized so that the instrument satisfies Hioki's internal standards.

### If an instrument is adjusted as part of calibration service

Values are optimized so that they satisfy Hioki's internal standards to reduce the risk that they will subsequently exceed the tolerance.

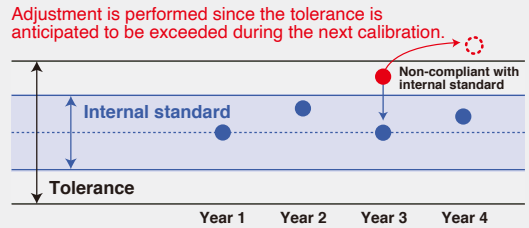

## Difference between general calibration and 17025 calibration (JCSS)



This is the mark of the calibration service provider registration program based on the Measurement Act. JCSS-registered service providers are registered under the ISO/IEC 17025 standard. HIOKI E.E. CORPORATION is an international MRA-capable JCSS-accredited service provider. HIOKI's accreditation number is JCSS 0156.

JCSS calibration is a type of third-party-accredited calibration based on ISO/IEC 17025. General calibration is a type of calibration determined by HIOKI based on ISO 9001. HIOKI can issue calibration certificates bearing the JCSS mark for instruments that have undergone JCSS certification, and they are valid internationally since they are international MRA-compliant.

### Differences in calibration points

- |   |   |
|---|---|
| <b>General calibration</b><br>Calibration is performed for all parameters that need to be checked in order to maintain the performance of the measuring instrument as determined by the product designer. | <b>17025 calibration (JCSS)</b><br>Calibration is performed using points registered as the JCSS calibration range and selected by the customer. |
|---|---|

### Differences in information on calibration documents

- |  |   |
|--|---|
| <b>General calibration</b> <ul style="list-style-type: none"> <li>• Calibration results: Included on inspection report</li> <li>• Inaccuracies: Not included</li> <li>• Traceability chart: Yes</li> </ul> | <b>17025 calibration (JCSS)</b> <ul style="list-style-type: none"> <li>• Calibration results: Included on calibration certificate</li> <li>• Inaccuracies: Included on calibration certificate</li> <li>• Traceability chart: No</li> </ul> (*JCSS and other logos certify traceability.) |
|--|---|

## Service capability and warranty duration

You can find out whether HIOKI accepts repair and calibration requests for your instrument, associated lead times if so, and the information listed below simply by entering the product model number on HIOKI's website.

Product Search: 0156A	Availability of repair and calibration service
Results	Calibration Interval
Product warranty period	Product warranty period
Date production discontinued	Date production discontinued

# Commemorating the 35th Anniversary of the HIOKI Battery Tester Series

# 35 years

## 1986

AC mΩ HITESTER  
3225



## 1998

AC mΩ HITESTER  
3560



## 2010

BATTERY HITESTER  
BT3562, BT3563



## 2015

BATTERY  
IMPEDANCE METER  
BT4560



## 2021

BATTERY HITESTER  
BT3561A, BT3562A, BT3563A

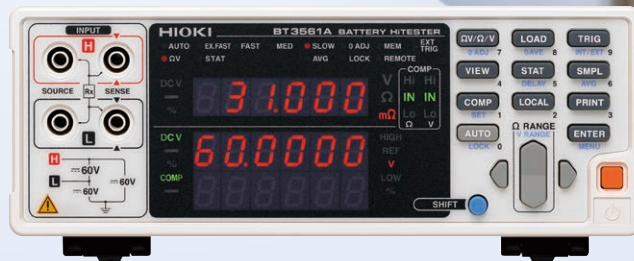

The history of HIOKI's battery tester series began with the release of the AC Milliohm HiTester 3225 in 1986. In 2020, Hioki commemorates its 35th anniversary as a strong leader in the industry. Hioki has seen the battery industry through its most critical stage of growth—the development and maturity of the Lithium-ion battery. LIB production sites of top battery manufacturers have proactively used HIOKI's battery testers, starting in Japan, then spreading globally to Korea and China. Today, Hioki is trusted around the globe as the world's de facto standard of battery testers for production as well as R&D.

## Measuring Instruments for the Battery Industry Solutions for Battery Production Processes

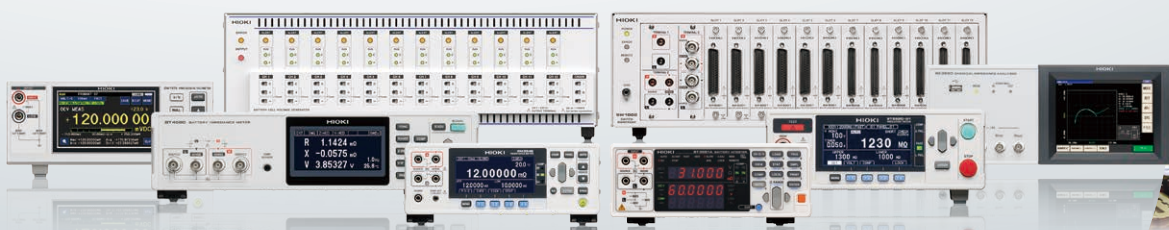

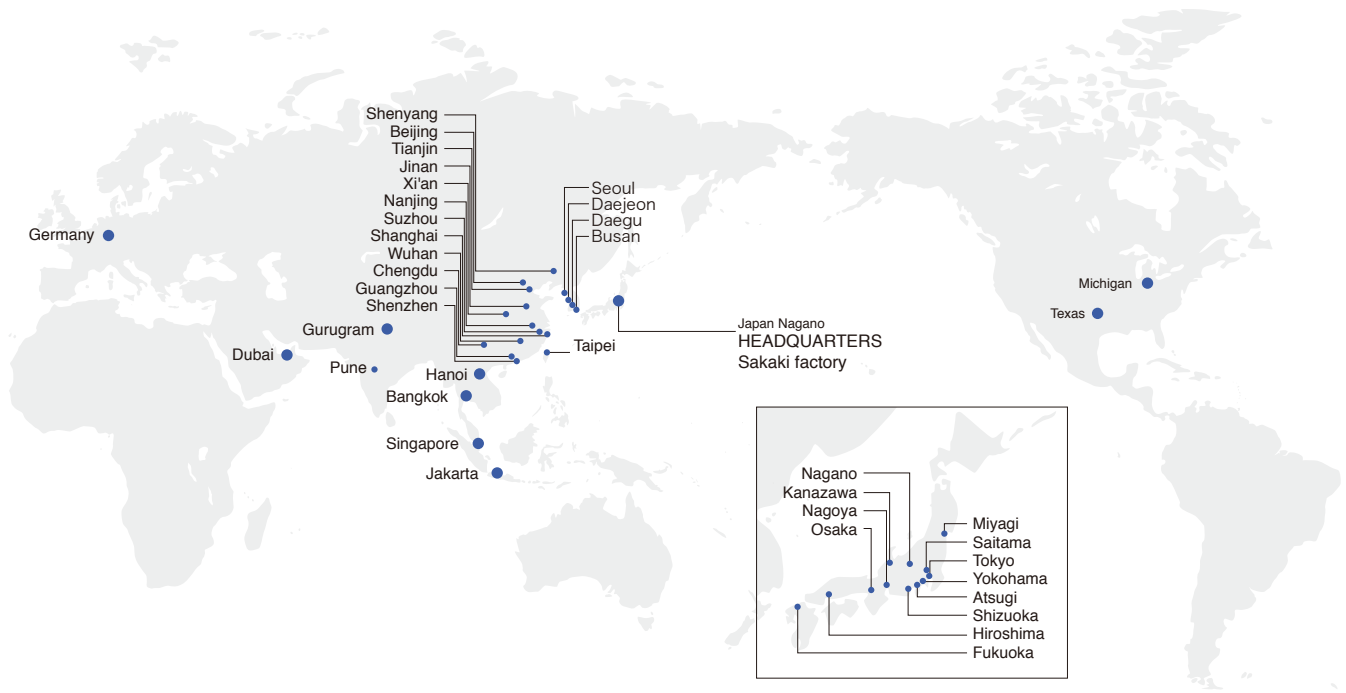

# Global sales network

Japan Bases	
	HEADQUARTERS : HIOKI E. E. CORPORATION (Nagano)
	Sakaki factory (Nagano)
	Tohoku Sales Branch (Miyagi)
	Nagano Sales Branch
	Kanazawa Sales Branch
	Kita-Kanto Sales Branch (Saitama)
Japan	Greater Tokyo Sales Branch
	Yokohama Sales Branch
	Atsugi Office
	Shizuoka Sales Branch
	Nagoya Sales Branch
	Osaka Sales Branch
	Hiroshima Office
	Fukuoka Sales Branch
Representative Offices	
China	Tianjin Representative Office (Tianjin)
UAE	MEA Representative Office (DUBAI)
Overseas Bases	
America	HIOKI USA CORPORATION (Plano, TX)
	HIOKI USA CORPORATION Michigan Office (Novi, MI)
	HIOKI (Shanghai) MEASUREMENT TECHNOLOGIES CO., LTD.
	HIOKI (Shanghai) TECHNOLOGY DEVELOPMENT CO., LTD.
	HIOKI (Shanghai) MEASURING INSTRUMENTS CO., LTD.
	HIOKI (Shanghai) MEASUREMENT TECHNOLOGIES CO., LTD. Beijing Representative Office
	HIOKI (Shanghai) MEASUREMENT TECHNOLOGIES CO., LTD. Guangzhou Representative Office
	HIOKI (Shanghai) MEASUREMENT TECHNOLOGIES CO., LTD. Shenzhen Representative Office
China	HIOKI (Shanghai) MEASUREMENT TECHNOLOGIES CO., LTD. Chengdu Representative Office
	HIOKI (Shanghai) MEASUREMENT TECHNOLOGIES CO., LTD. Suzhou Representative Office
	HIOKI (Shanghai) MEASUREMENT TECHNOLOGIES CO., LTD. Shenyang Representative Office
	HIOKI (Shanghai) MEASUREMENT TECHNOLOGIES CO., LTD. Xi'an Representative Office
	HIOKI (Shanghai) MEASUREMENT TECHNOLOGIES CO., LTD. Wuhan Representative Office
	HIOKI (Shanghai) MEASUREMENT TECHNOLOGIES CO., LTD. Jinan Representative Office
	HIOKI (Shanghai) MEASUREMENT TECHNOLOGIES CO., LTD. Nanjing Representative Office
Singapore	HIOKI SINGAPORE PTE. LTD. (Singapore)
Thailand	HIOKI SINGAPORE PTE. LTD. Thailand Representative Office
Vietnam	HIOKI SINGAPORE PTE. LTD. Vietnam Representative office
Indonesia	PT. HIOKI ELECTRIC INSTRUMENT (Jakarta)
	HIOKI KOREA CO., LTD. (Seoul)
Korea	HIOKI KOREA CO., LTD. Daejeon Office
	HIOKI KOREA CO., LTD. Busan Office
	HIOKI KOREA CO., LTD. Daegu Office
India	HIOKI INDIA PRIVATE LIMITED (Gurugram)
	HIOKI INDIA PRIVATE LIMITED Pune Office
Germany	HIOKI EUROPE GmbH (Eschborn)
Taiwan	HIOKI TAIWAN CO., LTD. (Taipei)

*Note: Company names and product names appearing in this brochure are trademarks or registered trademarks of various companies.*

**HIOKI**  
HIOKI E. E. CORPORATION

**HEADQUARTERS**  
81 Koizumi,  
Ueda, Nagano 386-1192 Japan  
<https://www.hioki.com/>



Scan for all regional contact information

DISTRIBUTED BY